

NAIS

NARROW-PITCH CONNECTORS FOR PC BOARDS

NARROW PITCH (0.4mm) CONNECTORS P4 SERIES

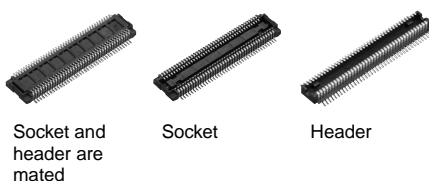
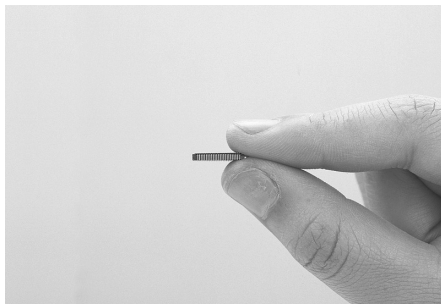

Ideal for FPC-to-PCB connections

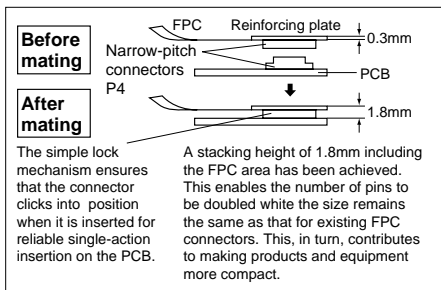

2. High impact-resistant construction.

1) Adoption of bellows-type contacts structure.

The roll surfaces are in contact with each other, providing high contact reliability.

Since the contact is formed by bending thin plate, it has a spring-like quality. This construction helps make it resistant to dropping and twisting.

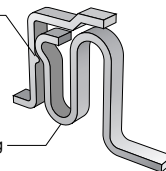

2) It is constructed with impact dispersion keys inside the body to disperse shocks when dropped.

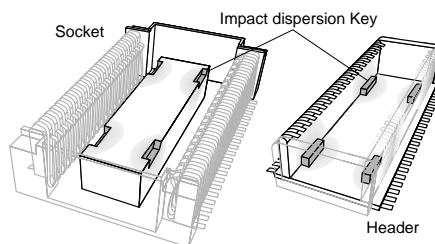

A high level of shock resistance is ensured by dispersing impact over the four locations where the socket indentations and header protrusions are mated together.

3. Construction makes designing devices easier.

1) The lower connector surface construction prevents contact and shorts between the PCB and metal terminals. This enables freedom in pattern wiring, helping to make PCB's smaller.

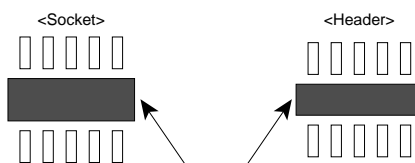

Connector bottom: Create any thru-hole pattern wiring.

2) Guides are provided to take up any position shift and facilitate insertion.

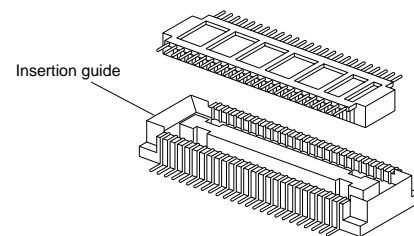

3) The connector has a simple lock mechanism.

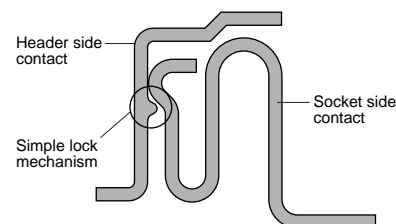

4. Design makes efficient mounting.

Features a terminal flatness of 0.08 mm, construction resistant to creeping flux, and design that facilitates visual inspection of the soldered part.

APPLICATIONS

- Cellular phones
- DVC
- Compact portable devices

FEATURES

1. A 0.4 mm pitch and stacking height of 1.5 mm allow for extra compactness and helps design lighter, thinner, shorter, and smaller devices.

PRODUCT TYPES

Stacking height	No. of contacts	Part No.		Packing	
		Socket	Header	Inner carton (1-reel)	Outer carton
1.5 mm	20	AXK720145*	AXK820145Y*	Note 1) "Asterisk" mark on end of part No.; J: 3,000 pieces V: 3,000 pieces	Note 1) "Asterisk" mark on end of part No.; J: 6,000 pieces V: 15,000 pieces
	24	AXK724145*	AXK824145Y*		
	26	AXK726145*	AXK826145Y*		
	30	AXK730145*	AXK830145Y*		
	34	AXK734145*	AXK834145Y*		
	40	AXK740145*	AXK840145Y*		
	50	AXK750145*	AXK850145Y*		
	60	AXK760145*	AXK860145Y*		
	70	AXK770145*	AXK870145Y*		
	80	AXK780145*	AXK880145Y*		
	100	AXK700145*	AXK800145Y*		

Notes) 1. Regarding ordering units: During production, Please make orders in 1-reel units. Samples for mounting confirmation: Please consult us. (See "Regarding sample orders to confirm proper mounting" on page 9.) Samples: Small lot orders are possible.

2. The standard type comes with no positioning bosses. Connectors with positioning bosses are available for on-demand production. For this type of connector, 8th digit of the part no. changes from 4 to 3. e.g. Stacking height 1.5mm 20 contacts for sockets: AXK720135J

3. Connectors with holding metal are available for on-demand production.

AXK(7/8)

SPECIFICATIONS

1. Characteristics

Item	Specifications	Conditions																
Electrical characteristics	Rated current	0.3A/contact (Max. 5 A at total contacts)																
	Rated voltage	60V AC/DC																
	Breakdown voltage	150V AC for 1 minute	Detection current: 1mA															
	Insulation resistance	Min. 1,000M Ω (initial)	Using 250V DC megger (applied for 1 min.)															
	Contact resistance	Max. 70m Ω	Measured based on the HP4338B measurement method of JIS C 5402															
Mechanical characteristics	Composite insertion force	Max. 0.981N {100gf}/contacts \times contacts (initial)																
	Composite removal force	Min. 0.0588N {6gf}/contacts \times contacts																
	Post holding force	Min. 0.981N {100gf}/contact	Measures the maximum load in the post axial direction until removal															
Environmental characteristics	Ambient temperature	-55°C to +85°C	No freezing at low temperatures															
	Soldering heat resistance	Max. peak temperature of 245°C	Infrared reflow soldering															
		300°C within 5 seconds	Soldering iron															
	Thermal shock resistance (header and socket mated)	5 cycles, insulation resistance min. 100M Ω , contact resistance max. 70m Ω	<table border="1"> <thead> <tr> <th>Sequence</th> <th>Temperature (°C)</th> <th>Time (minutes)</th> </tr> </thead> <tbody> <tr> <td>1</td> <td>-55$^{+10}_{-3}$</td> <td>30</td> </tr> <tr> <td>2</td> <td>25$^{+10}_{-5}$</td> <td>Max. 5</td> </tr> <tr> <td>3</td> <td>85$^{+3}_{-0}$</td> <td>30</td> </tr> <tr> <td>4</td> <td>25$^{+10}_{-5}$</td> <td>Max. 5</td> </tr> </tbody> </table>	Sequence	Temperature (°C)	Time (minutes)	1	-55 $^{+10}_{-3}$	30	2	25 $^{+10}_{-5}$	Max. 5	3	85 $^{+3}_{-0}$	30	4	25 $^{+10}_{-5}$	Max. 5
	Sequence	Temperature (°C)	Time (minutes)															
	1	-55 $^{+10}_{-3}$	30															
	2	25 $^{+10}_{-5}$	Max. 5															
	3	85 $^{+3}_{-0}$	30															
4	25 $^{+10}_{-5}$	Max. 5																
Humidity resistance (header and socket mated)	120 hours, insulation resistance min. 100M Ω , contact resistance max. 70m Ω	Bath temperature 40 \pm 2°C, humidity 90 to 95% R.H.																
Saltwater spray resistance (header and socket mated)	24 hours, insulation resistance min. 100M Ω , contact resistance max. 70m Ω	Bath temperature 35 \pm 2°C, saltwater concentration 5 \pm 1%																
H ₂ S resistance (header and socket mated)	48 hours, contact resistance max. 70m Ω	Bath temperature 40 \pm 2°C, gas concentration 3 \pm 1 ppm, humidity 75 to 80% R.H.																
Insertion and removal life	50 times	Repeated insertion and removal speed of max. 200 times/hours																
Unit weight	Stacking height 1.5mm, 20 contacts; Socket: 0.04g Header: 0.02g																	

2. Material and surface treatment

Part name	Material	Surface treatment
Molded portion	Heat-resistant resin (UL94V-0), Black	—
Contact/Post	Copper alloy	Contact portion: Au plating over Ni Terminal portion: Au plating over Ni (Except for thick of terminal)

DIMENSIONS

mm General tolerance \pm 0.2

• Socket (stacking height: 1.5mm)

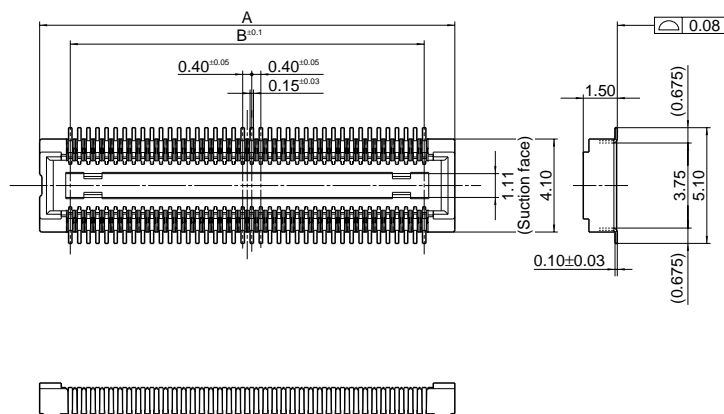

Dimension table (mm)

No. of contacts	A	B
20	6.3	3.6
24	7.1	4.4
26	7.5	4.8
30	8.3	5.6
34	9.1	6.4
40	10.3	7.6
50	12.3	9.6
60	14.3	11.6
70	16.3	13.6
80	18.3	15.6
100	22.3	19.6

• Header (stacking height: 1.5mm)

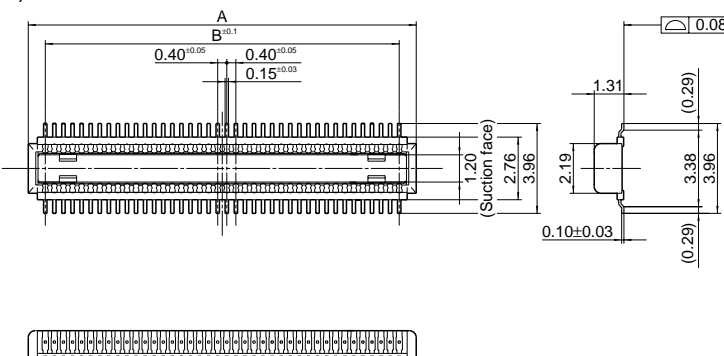

Dimension table (mm)

No. of contacts	A	B
20	5.1	3.6
24	5.9	4.4
26	6.3	4.8
30	7.1	5.6
34	7.9	6.4
40	9.1	7.6
50	11.1	9.6
60	13.1	11.6
70	15.1	13.6
80	17.1	15.6
100	21.1	19.6

- Socket and header are mated
Stacking height 1.5 mm

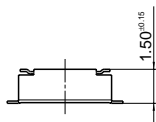

EMBOSSED TAPE DIMENSIONS

Please refer to page 56.

NOTES

1. As shown below, excess force during insertion may result in damage to the connector or removal of the solder. Please be careful. Also, to prevent connector damage please confirm the correct position before mating connectors.

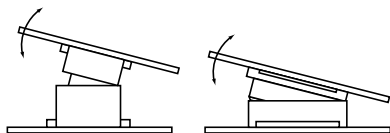

2. Keep the PC board warp no more than 0.03 mm in relation to the overall length of the connector.

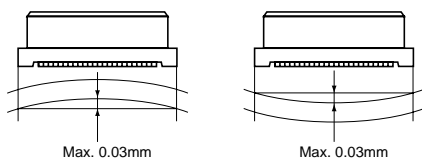

3. PC Boards and Recommended Metal Mask Patterns

Connectors are mounted with high density, with a pitch interval of 0.4 to 0.5 mm. It is therefore necessary to make sure that the right levels of solder are used, in order to reduce solder bridge and other issues. The figures to the right are recommended metal mask patterns. Please use them as a reference.

- Socket

Recommended PC board pattern
(TOP VIEW)

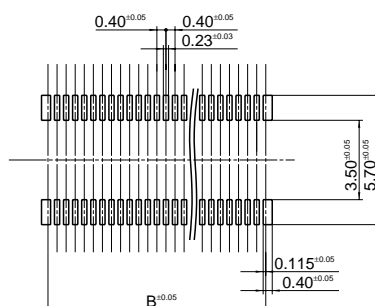

Recommended metal mask pattern
Metal mask thickness: Here, 150 μm
(Opening area ratio: 40%)

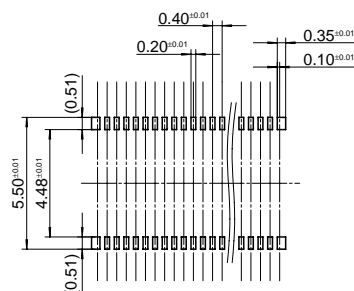

Recommended metal mask pattern
Metal mask thickness: Here, 120 μm
(Opening area ratio: 50%)

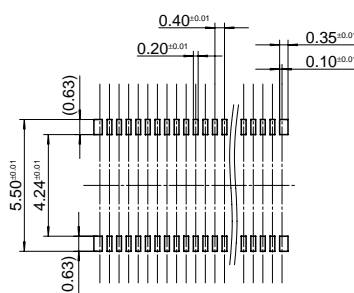

- Header

Recommended PC board pattern
(TOP VIEW)

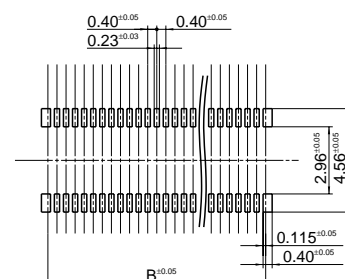

Recommended metal mask pattern
Metal mask thickness: Here, 150 μm
(Opening area ratio: 32%)

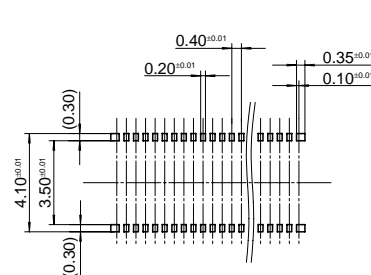

Recommended metal mask pattern
Metal mask thickness: Here, 120 μm
(Opening area ratio: 40%)

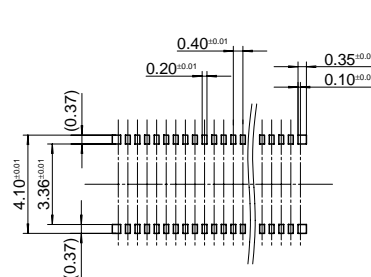

* See the dimension table on page 14 for more information on the B dimension of the socket and header.

Regarding general notes, please refer to pages 8 and 9.