

3A LOW DROPOUT LINEAR REGULATOR**AZ1085C****General Description**

The AZ1085C is a series of low dropout positive voltage regulators with a maximum dropout of 1.5V at 3A of load current.

The series features on-chip thermal shutdown. It also includes a bandgap reference and a current limiting circuit.

The AZ1085C is available in 1.5V, 1.8V, 2.5V, 3.3V, 5.0V and adjustable versions. The fixed versions integrate the adjust resistors. The adjustable version can set the output voltage with two external resistors.

The AZ1085C series is available in standard packages of TO-263-3, TO-263-2, TO-252-2 (3) and TO-252-2 (4).

Features

- Low Dropout Voltage: Typical 1.3V at 3A
- Current Limiting and Thermal Protection
- Output Current: 3A
- Current Limit: 4.5A
- Operating Junction Temperature: 0 to 125°C
- Compatible with Low ESR Ceramic Capacitor
- Line Regulation: 0.015% (Typ)
- Load Regulation: 0.1% (Typ)

Applications

- High Efficiency Linear Regulators
- Battery Charger
- Post Regulation for Switching Supplies
- Microprocessor Supply
- Mother Board Power Supplies
- DVD-Video Player
- Telecom Equipment
- Set Top boxes and Web Boxes Modules' Supply

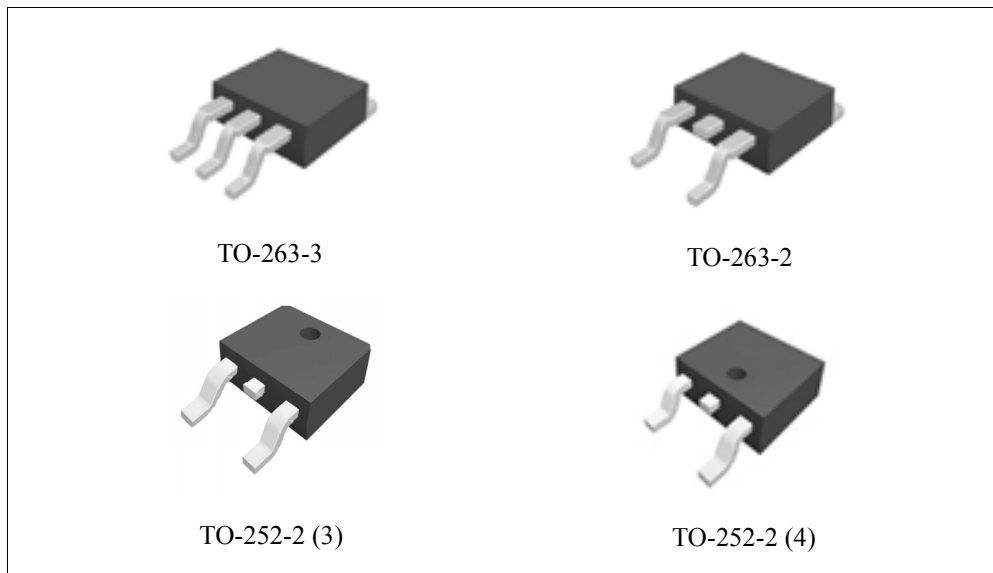

Figure 1. Package Types of AZ1085C

3A LOW DROPOUT LINEAR REGULATOR**AZ1085C****Pin Configuration**

Figure 2. Pin Configuration of AZ1085C (Top View)

3A LOW DROPOUT LINEAR REGULATOR

AZ1085C

Functional Block Diagram

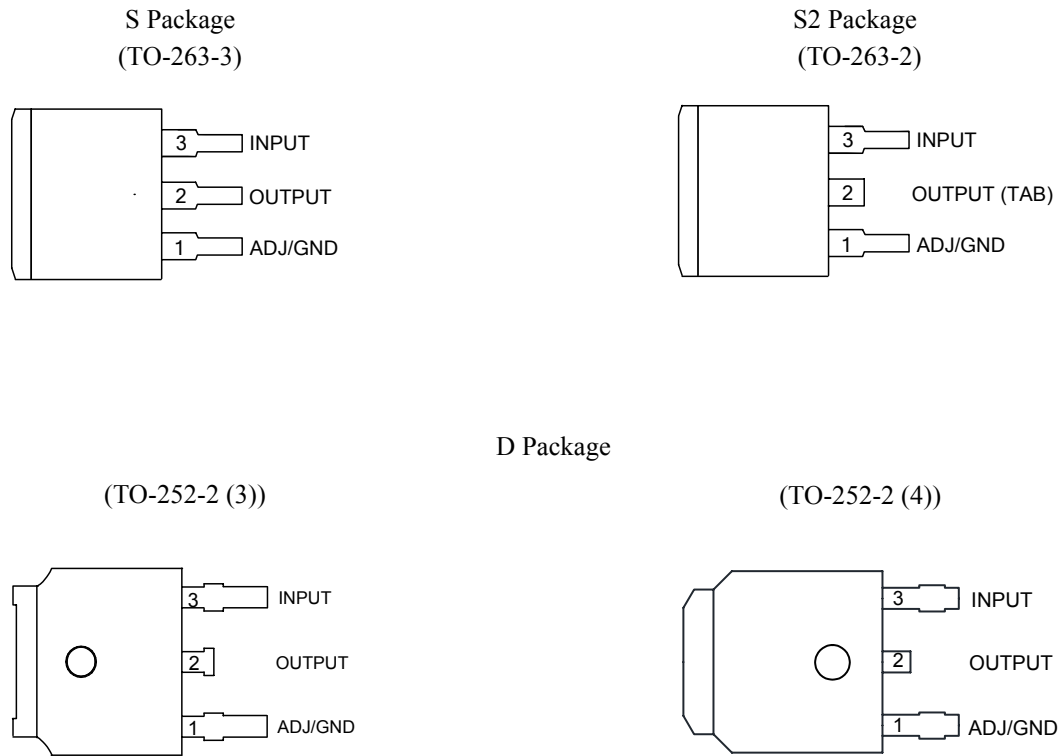
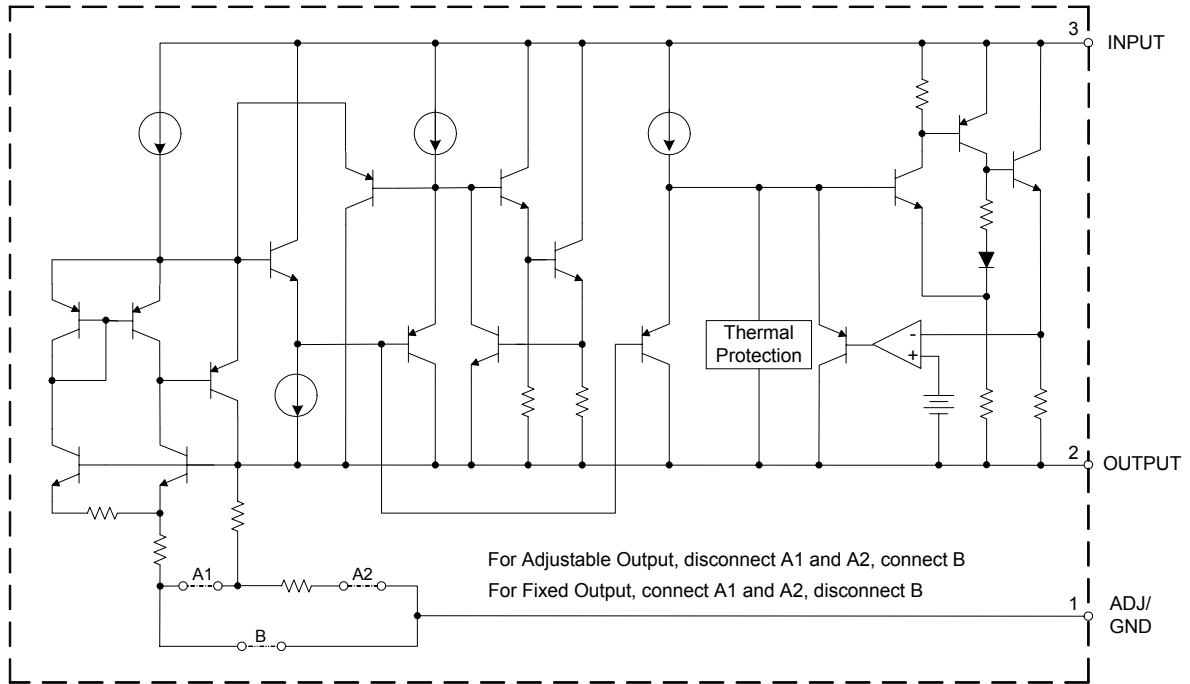

Figure 3. Functional Block Diagram of AZ1085C



3A LOW DROPOUT LINEAR REGULATOR

AZ1085C

Ordering Information

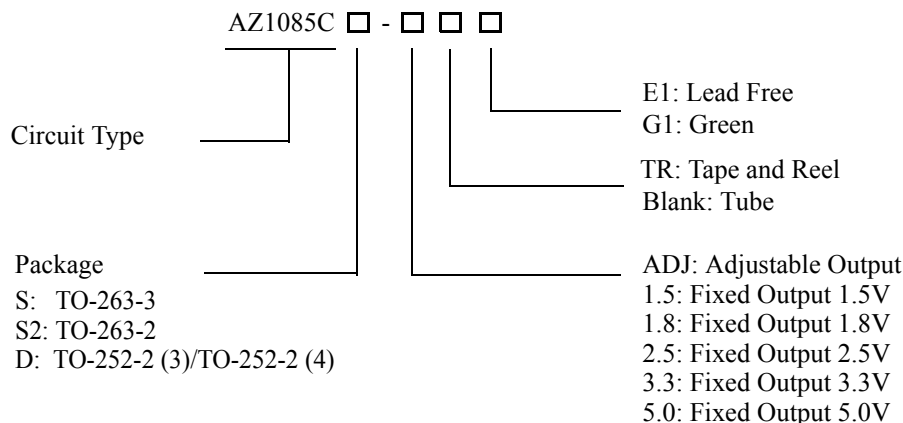

Package	Temperature Range	Part Number		Marking ID		Packing Type
		Lead Free	Green	Lead Free	Green	
TO-263-3	0 to 125°C	AZ1085CS-ADJE1	AZ1085CS-ADJG1	AZ1085CS-ADJE1	AZ1085CS-ADJG1	Tube
		AZ1085CS-ADJTRE1	AZ1085CS-ADJTRG1	AZ1085CS-ADJE1	AZ1085CS-ADJG1	Tape & Reel
		AZ1085CS-1.5E1	AZ1085CS-1.5G1	AZ1085CS-1.5E1	AZ1085CS-1.5G1	Tube
		AZ1085CS-1.5TRE1	AZ1085CS-1.5TRG1	AZ1085CS-1.5E1	AZ1085CS-1.5G1	Tape & Reel
		AZ1085CS-1.8E1	AZ1085CS-1.8G1	AZ1085CS-1.8E1	AZ1085CS-1.8G1	Tube
		AZ1085CS-1.8TRE1	AZ1085CS-1.8TRG1	AZ1085CS-1.8E1	AZ1085CS-1.8G1	Tape & Reel
		AZ1085CS-2.5E1	AZ1085CS-2.5G1	AZ1085CS-2.5E1	AZ1085CS-2.5G1	Tube
		AZ1085CS-2.5TRE1	AZ1085CS-2.5TRG1	AZ1085CS-2.5E1	AZ1085CS-2.5G1	Tape & Reel
		AZ1085CS-3.3E1	AZ1085CS-3.3G1	AZ1085CS-3.3E1	AZ1085CS-3.3G1	Tube
		AZ1085CS-3.3TRE1	AZ1085CS-3.3TRG1	AZ1085CS-3.3E1	AZ1085CS-3.3G1	Tape & Reel
		AZ1085CS-5.0E1	AZ1085CS-5.0G1	AZ1085CS-5.0E1	AZ1085CS-5.0G1	Tube
AZ1085CS-5.0TRE1	AZ1085CS-5.0TRG1	AZ1085CS-5.0E1	AZ1085CS-5.0G1	Tape & Reel		
TO-263-2	0 to 125°C	AZ1085CS2-ADJE1	AZ1085CS2-ADJG1	AZ1085CS2-ADJE1	AZ1085CS2-ADJG1	Tube
		AZ1085CS2-ADJTRE1	AZ1085CS2-ADJTRG1	AZ1085CS2-ADJE1	AZ1085CS2-ADJG1	Tape & Reel
		AZ1085CS2-1.5E1	AZ1085CS2-1.5G1	AZ1085CS2-1.5E1	AZ1085CS2-1.5G1	Tube
		AZ1085CS2-1.5TRE1	AZ1085CS2-1.5TRG1	AZ1085CS2-1.5E1	AZ1085CS2-1.5G1	Tape & Reel
		AZ1085CS2-1.8E1	AZ1085CS2-1.8G1	AZ1085CS2-1.8E1	AZ1085CS2-1.8G1	Tube
		AZ1085CS2-1.8TRE1	AZ1085CS2-1.8TRG1	AZ1085CS2-1.8E1	AZ1085CS2-1.8G1	Tape & Reel
		AZ1085CS2-2.5E1	AZ1085CS2-2.5G1	AZ1085CS2-2.5E1	AZ1085CS2-2.5G1	Tube
		AZ1085CS2-2.5TRE1	AZ1085CS2-2.5TRG1	AZ1085CS2-2.5E1	AZ1085CS2-2.5G1	Tape & Reel
		AZ1085CS2-3.3E1	AZ1085CS2-3.3G1	AZ1085CS2-3.3E1	AZ1085CS2-3.3G1	Tube
		AZ1085CS2-3.3TRE1	AZ1085CS2-3.3TRG1	AZ1085CS2-3.3E1	AZ1085CS2-3.3G1	Tape & Reel
		AZ1085CS2-5.0E1	AZ1085CS2-5.0G1	AZ1085CS2-5.0E1	AZ1085CS2-5.0G1	Tube
AZ1085CS2-5.0TRE1	AZ1085CS2-5.0TRG1	AZ1085CS2-5.0E1	AZ1085CS2-5.0G1	Tape & Reel		

**3A LOW DROPOUT LINEAR REGULATOR****AZ1085C****Ordering Information**

Package	Temperature Range	Part Number		Marking ID		Packing Type
		Lead Free	Green	Lead Free	Green	
TO-252-2 (3)/ TO-252-2 (4)	0 to 125°C	AZ1085CD-ADJE1	AZ1085CD-ADJG1	AZ1085CD-ADJE1	AZ1085CD-ADJG1	Tube
		AZ1085CD-ADJTRE1	AZ1085CD-ADJTRG1	AZ1085CD-ADJE1	AZ1085CD-ADJG1	Tape & Reel
		AZ1085CD-1.5E1	AZ1085CD-1.5G1	AZ1085CD-1.5E1	AZ1085CD-1.5G1	Tube
		AZ1085CD-1.5TRE1	AZ1085CD-1.5TRG1	AZ1085CD-1.5E1	AZ1085CD-1.5G1	Tape & Reel
		AZ1085CD-1.8E1	AZ1085CD-1.8G1	AZ1085CD-1.8E1	AZ1085CD-1.8G1	Tube
		AZ1085CD-1.8TRE1	AZ1085CD-1.8TRG1	AZ1085CD-1.8E1	AZ1085CD-1.8G1	Tape & Reel
		AZ1085CD-2.5E1	AZ1085CD-2.5G1	AZ1085CD-2.5E1	AZ1085CD-2.5G1	Tube
		AZ1085CD-2.5TRE1	AZ1085CD-2.5TRG1	AZ1085CD-2.5E1	AZ1085CD-2.5G1	Tape & Reel
		AZ1085CD-3.3E1	AZ1085CD-3.3G1	AZ1085CD-3.3E1	AZ1085CD-3.3G1	Tube
		AZ1085CD-3.3TRE1	AZ1085CD-3.3TRG1	AZ1085CD-3.3E1	AZ1085CD-3.3G1	Tape & Reel
		AZ1085CD-5.0E1	AZ1085CD-5.0G1	AZ1085CD-5.0E1	AZ1085CD-5.0G1	Tube
		AZ1085CD-5.0TRE1	AZ1085CD-5.0TRG1	AZ1085CD-5.0E1	AZ1085CD-5.0G1	Tape & Reel

BCD Semiconductor's Pb-free products, as designated with "E1" suffix in the part number, are RoHS compliant. Products with "G1" suffix are available in green packages.

**3A LOW DROPOUT LINEAR REGULATOR****AZ1085C****Absolute Maximum Ratings (Note 1)**

Parameter	Symbol	Value		Unit
Operating Junction Temperature	T_J	150		°C
Storage Temperature Range	T_{STG}	-65 to 150		°C
Lead Temperature (Soldering, 10sec)	T_{LEAD}	260		°C
Thermal Resistance(Note 2)	θ_{JA}	TO-263-3	75	°C/W
		TO-263-2	75	
		TO-252-2 (3)/TO-252-2 (4)	100	
ESD (Human Body Model)	ESD	2000		V

Note 1: Stresses greater than those listed under "Absolute Maximum Ratings" may cause permanent damage to the device. These are stress ratings only, and functional operation of the device at these or any other conditions beyond those indicated under "Recommended Operating Conditions" is not implied. Exposure to "Absolute Maximum Ratings" for extended periods may affect device reliability.

Note 2: Absolute maximum ratings indicate limits beyond which damage to the component may occur. Electrical specifications do not apply when operating the device outside of its operating ratings. The maximum allowable power dissipation is a function of the maximum junction temperature, $T_{J(max)}$, the junction-to-ambient thermal resistance, θ_{JA} , and the ambient temperature, T_A . The maximum allowable power dissipation at any ambient temperature is calculated using: $P_{D(max)} = (T_{J(max)} - T_A) / \theta_{JA}$. Exceeding the maximum allowable power dissipation will result in excessive die temperature, and the regulator will go into thermal shutdown.

Recommended Operating Conditions

Parameter	Symbol	Min	Max	Unit
Input Voltage	V_{IN}		12	V
Operating Junction Temperature Range	T_J	0	125	°C



3A LOW DROPOUT LINEAR REGULATOR

AZ1085C

Electrical Characteristics

Typicals and limits appearing in normal type apply for $T_J=25^\circ\text{C}$. Limits appearing in **Boldface** type apply over the entire operating junction temperature range 0 to 125°C .

Parameter	Symbol	Conditions	Min	Typ	Max	Unit
Reference Voltage	V_{REF}	AZ1085C-ADJ, $I_{OUT}=10\text{mA}$, $V_{IN}-V_{OUT}=3\text{V}$, $T_J=25^\circ\text{C}$, $10\text{mA} \leq I_{OUT} \leq 3\text{A}$, $1.5\text{V} \leq V_{IN}-V_{OUT} \leq 5\text{V}$	1.238 1.225	1.250 1.250	1.262 1.275	V
Output Voltage	V_{OUT}	AZ1085C-1.5, $I_{OUT}=0\text{mA}$, $V_{IN}=4.5\text{V}$, $T_J=25^\circ\text{C}$, $10\text{mA} \leq I_{OUT} \leq 3\text{A}$, $3.0\text{V} \leq V_{IN} \leq 6\text{V}$	1.485 1.47	1.5 1.5	1.515 1.53	V
		AZ1085C-1.8, $I_{OUT}=0\text{mA}$, $V_{IN}=4.8\text{V}$, $T_J=25^\circ\text{C}$, $10\text{mA} \leq I_{OUT} \leq 3\text{A}$, $3.3\text{V} \leq V_{IN} \leq 7\text{V}$	1.782 1.764	1.8 1.8	1.818 1.836	V
		AZ1085C-2.5, $I_{OUT}=0\text{mA}$, $V_{IN}=5.5\text{V}$, $T_J=25^\circ\text{C}$, $10\text{mA} \leq I_{OUT} \leq 3\text{A}$, $4.0\text{V} \leq V_{IN} \leq 7\text{V}$	2.475 2.45	2.5 2.5	2.525 2.55	V
		AZ1085C-3.3, $I_{OUT}=0\text{mA}$, $V_{IN}=6.3\text{V}$, $T_J=25^\circ\text{C}$, $10\text{mA} \leq I_{OUT} \leq 3\text{A}$, $4.8\text{V} \leq V_{IN} \leq 8\text{V}$	3.267 3.234	3.3 3.3	3.333 3.366	V
		AZ1085C-5.0, $I_{OUT}=0\text{mA}$, $V_{IN}=8\text{V}$, $T_J=25^\circ\text{C}$, $10\text{mA} \leq I_{OUT} \leq 3\text{A}$, $6.5\text{V} \leq V_{IN} \leq 10\text{V}$	4.95 4.9	5 5	5.05 5.1	V
Line Regulation	ΔV_{OUT}	AZ1085C-ADJ, $I_{OUT}=10\text{mA}$, $2.85\text{V} \leq V_{IN} \leq 10\text{V}$		0.015 0.035	0.2 0.2	%
		AZ1085C-1.5, $I_{OUT}=10\text{mA}$, $3.0\text{V} \leq V_{IN} \leq 10\text{V}$		0.5 1	6 6	mV
		AZ1085C-1.8, $I_{OUT}=10\text{mA}$, $3.3\text{V} \leq V_{IN} \leq 10\text{V}$		0.5 1	6 6	mV
		AZ1085C-2.5, $I_{OUT}=10\text{mA}$, $4.0\text{V} \leq V_{IN} \leq 10\text{V}$		0.5 1	6 6	mV
		AZ1085C-3.3, $I_{OUT}=10\text{mA}$, $4.8\text{V} \leq V_{IN} \leq 10\text{V}$		0.5 1	6 6	mV
		AZ1085C-5.0, $I_{OUT}=10\text{mA}$, $6.5\text{V} \leq V_{IN} \leq 10\text{V}$		0.5 1	10 10	mV



3A LOW DROPOUT LINEAR REGULATOR

AZ1085C

Electrical Characteristics (Continued)

Typicals and limits appearing in normal type apply for $T_J=25^\circ\text{C}$. Limits appearing in **Boldface** type apply over the entire operating junction temperature range 0 to 125°C .

Parameter	Symbol	Conditions	Min	Typ	Max	Unit
Load Regulation	ΔV_{OUT}	AZ1085C-ADJ, $0\text{mA} \leq I_{OUT} \leq 3\text{A}$, $V_{IN} - V_{OUT} = 3\text{V}$		0.1 0.2	0.3 0.4	%
		AZ1085C-1.5, $0\text{mA} \leq I_{OUT} \leq 3\text{A}$, $V_{IN} - V_{OUT} = 3\text{V}$		3 7	15 20	mV
		AZ1085C-1.8, $0\text{mA} \leq I_{OUT} \leq 3\text{A}$, $V_{IN} - V_{OUT} = 3\text{V}$		3 7	15 20	mV
		AZ1085C-2.5, $0\text{mA} \leq I_{OUT} \leq 3\text{A}$, $V_{IN} - V_{OUT} = 3\text{V}$		3 7	15 20	mV
		AZ1085C-3.3, $0\text{mA} \leq I_{OUT} \leq 3\text{A}$, $V_{IN} - V_{OUT} = 3\text{V}$		3 7	15 20	mV
		AZ1085C-5.0, $0\text{mA} \leq I_{OUT} \leq 3\text{A}$, $V_{IN} - V_{OUT} = 3\text{V}$		5 10	20 35	mV
Dropout Voltage	V_{DROP}	$I_{OUT} = 3\text{A}$, ΔV_{REF} , $\Delta V_{OUT} = 1\%$		1.3	1.5	V
Thermal Resistance (Junction to Case)	θ_{JC}	TO-263-3		6.34		$^\circ\text{C/W}$
		TO-263-2		6.34		
		TO-252-2 (3)/TO-252-2 (4)		7.36		
Current Limit	I_{LIMIT}	$V_{IN} - V_{OUT} = 3\text{V}$	3.2	4.5		A
Minimum Load Current	I_{LOAD} (MIN)	$V_{IN} = 10\text{V}$ (AZ1085C-ADJ)		3	10	mA
Quiescent Current	I_Q	$V_{IN} = 10\text{V}$ (AZ1085C)		5	10	mA
Ripple Rejection	PSRR	$f_{RIPPLE} = 120\text{Hz}$, $C_{OUT} = 25\mu\text{F}$, $I_{OUT} = 3\text{A}$, $V_{IN} - V_{OUT} = 3\text{V}$	60	72		dB
Adjust Pin Current	I_{ADJ}	$V_{IN} = 4.25\text{V}$, $I_{OUT} = 10\text{mA}$		55	120	μA
Adjust Pin Current Change	ΔI_{ADJ}	$10\text{mA} \leq I_{OUT} \leq 3\text{A}$, $1.5\text{V} \leq V_{IN} - V_{OUT} \leq 6\text{V}$		0.2	5	μA
Long Term Stability		$T_A = 125^\circ\text{C}$, 1000Hrs		0.5		%
Temperature Stability		$I_{OUT} = 10\text{mA}$, $V_{IN} - V_{OUT} = 1.5\text{V}$		0.5		%
RMS Noise (% of V_{OUT})		$T_A = 25^\circ\text{C}$, $10\text{Hz} \leq f \leq 10\text{kHz}$		0.003		%



3A LOW DROPOUT LINEAR REGULATOR

AZ1085C

Typical Performance Characteristics

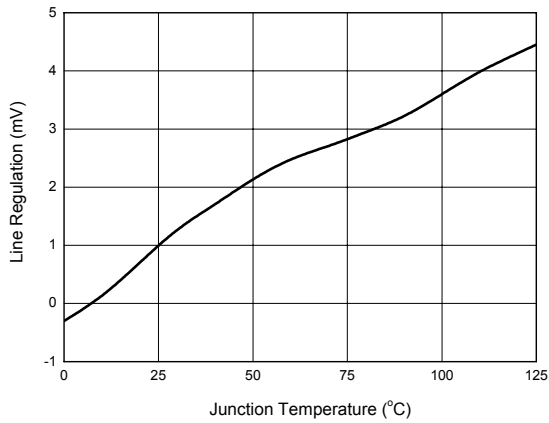

Figure 4. Line Regulation vs. Junction Temperature

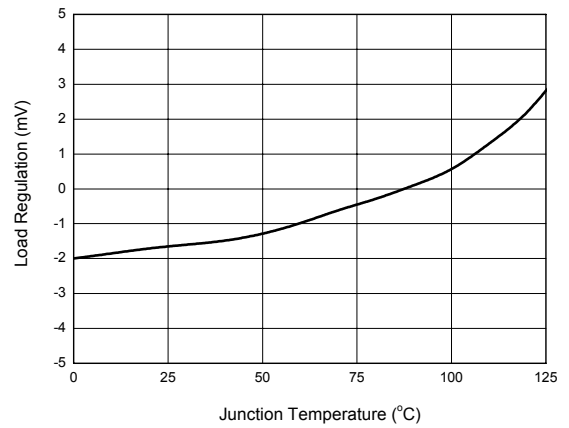

Figure 5. Load Regulation vs. Junction Temperature

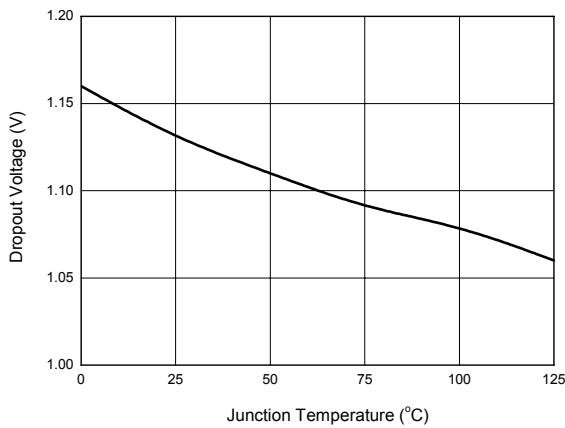

Figure 6. Dropout Voltage vs. Junction Temperature

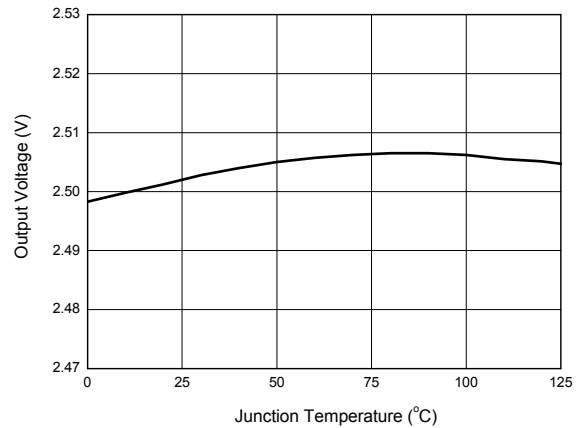

Figure 7. Output Voltage vs. Junction Temperature



3A LOW DROPOUT LINEAR REGULATOR

AZ1085C

Typical Performance Characteristics (Continued)

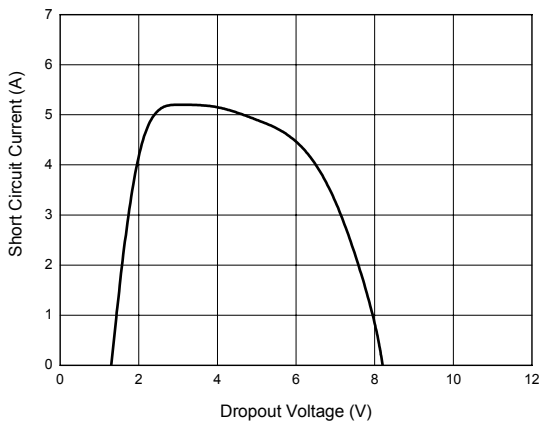

Figure 8. Short Circuit Current vs. Dropout Voltage

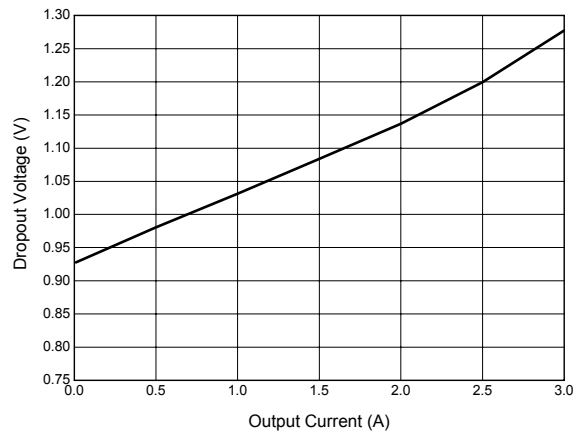

Figure 9. Dropout Voltage vs. Output Current

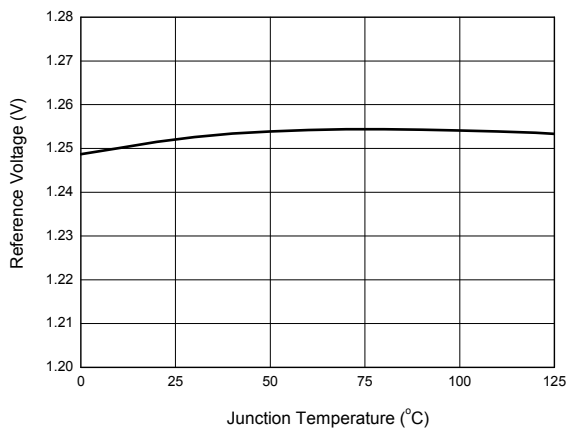

Figure 10. Reference Voltage vs. Junction Temperature

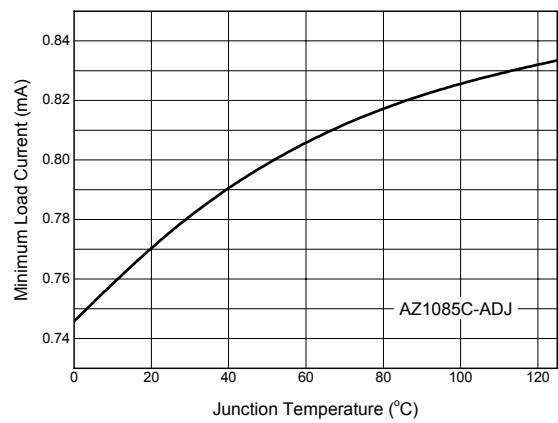

Figure 11. Minimum Load Current vs. Junction Temperature



3A LOW DROPOUT LINEAR REGULATOR

AZ1085C

Typical Performance Characteristics (Continued)

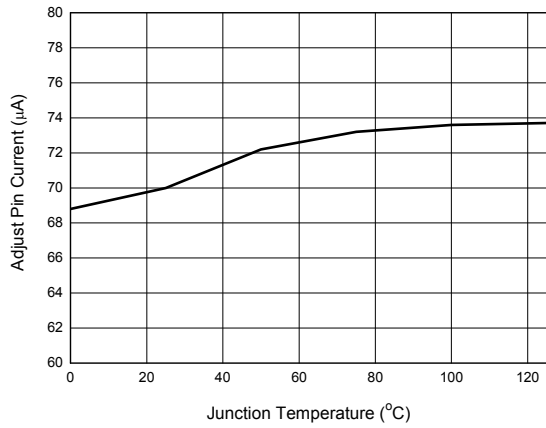

Figure12. Adjust Pin Current vs. Junction Temperature

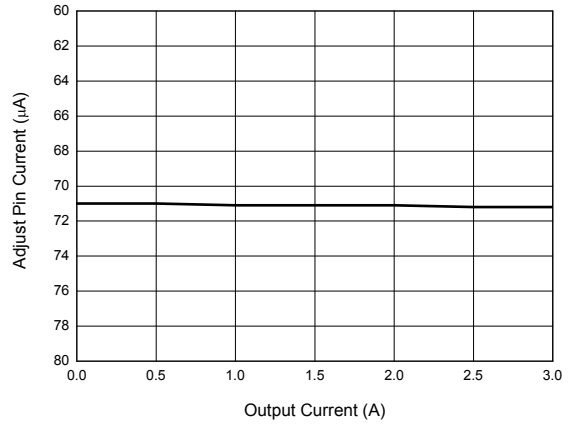

Figure13. Adjust Pin Current vs. Output Current

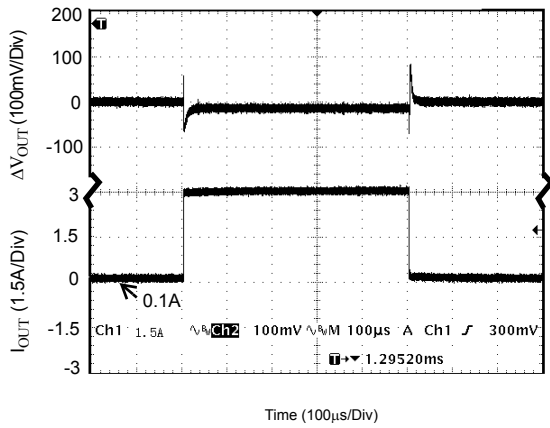

Figure 14. Load Transient Response
(Conditions: $V_{IN}=5.5V$, $V_{OUT}=2.5V$, $I_{OUT}=100mA$ to $3A$,
 $C_{IN}=C_{OUT}=10\mu F$)

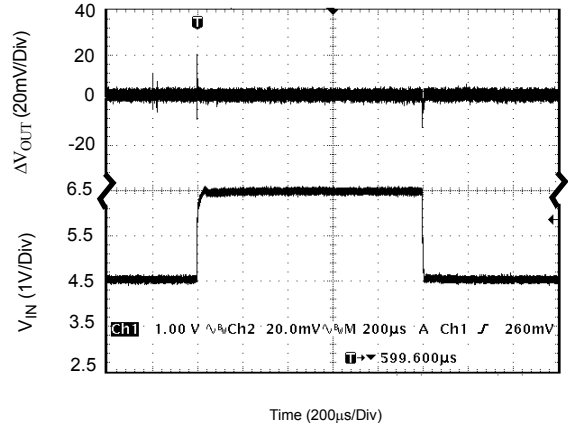

Figure 15. Line Transient Response
(Conditions: $V_{IN}=4.5V$ to $6.5V$, $V_{OUT}=2.5V$,
 $I_{OUT}=200mA$, $C_{IN}=1\mu F$, $C_{OUT}=10\mu F$)



3A LOW DROPOUT LINEAR REGULATOR

AZ1085C

Typical Performance Characteristics (Continued)

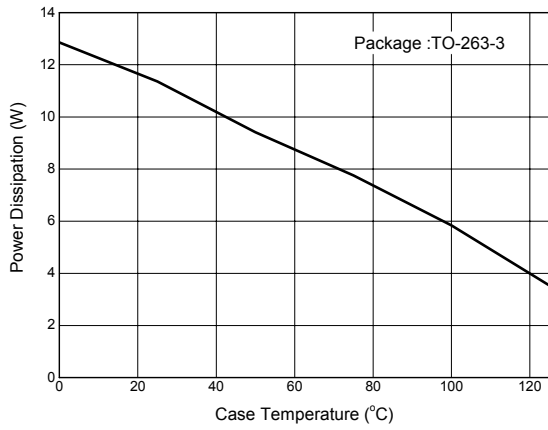

Figure16. Power Dissipation vs. Case Temperature

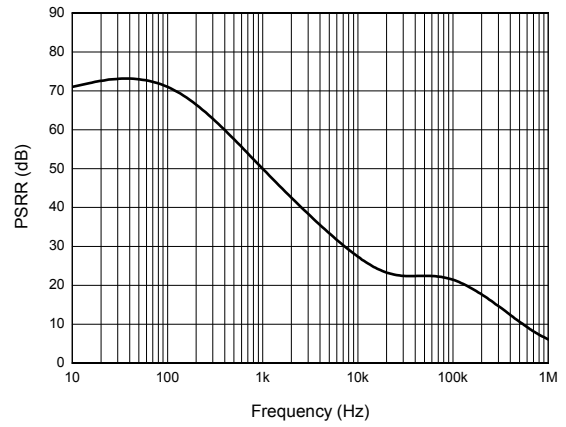

Figure17. PSRR vs. Frequency

Typical Application

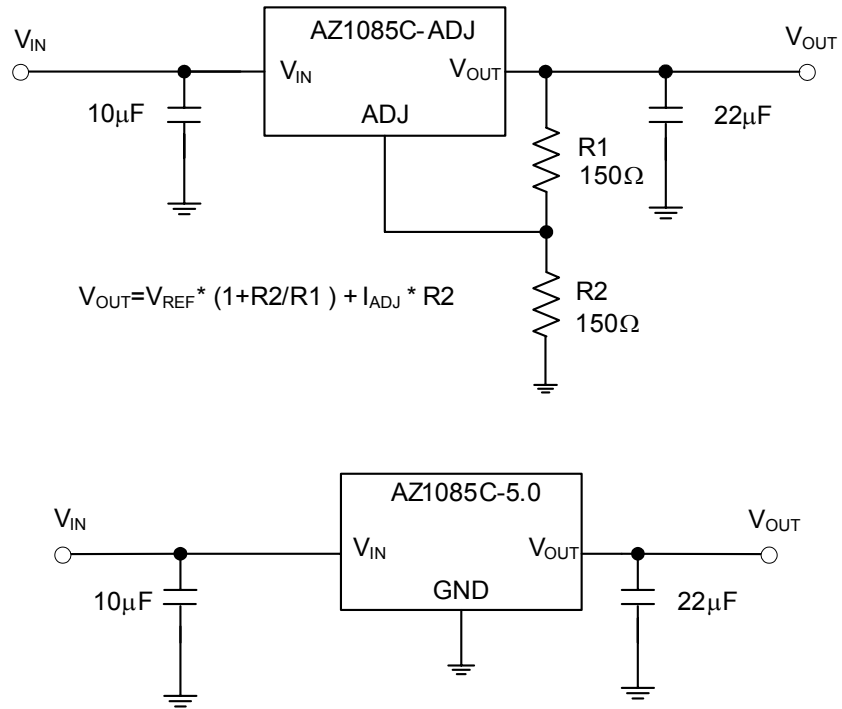

Figure 18. Typical Applications of AZ1085C



3A LOW DROPOUT LINEAR REGULATOR

AZ1085C

Mechanical Dimensions

TO-263-3

Unit: mm(inch)

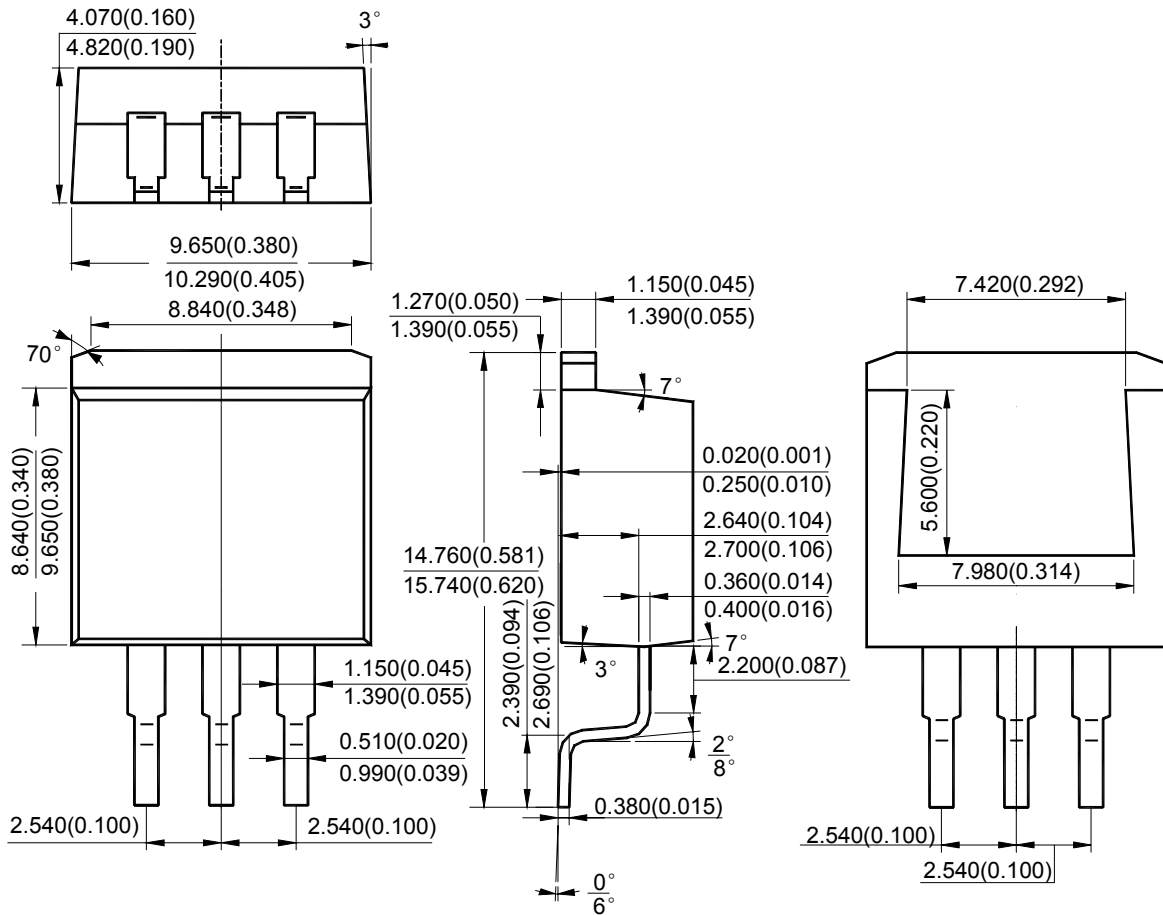



3A LOW DROPOUT LINEAR REGULATOR

AZ1085C

Mechanical Dimensions (Continued)

TO-263-2

Unit: mm(inch)

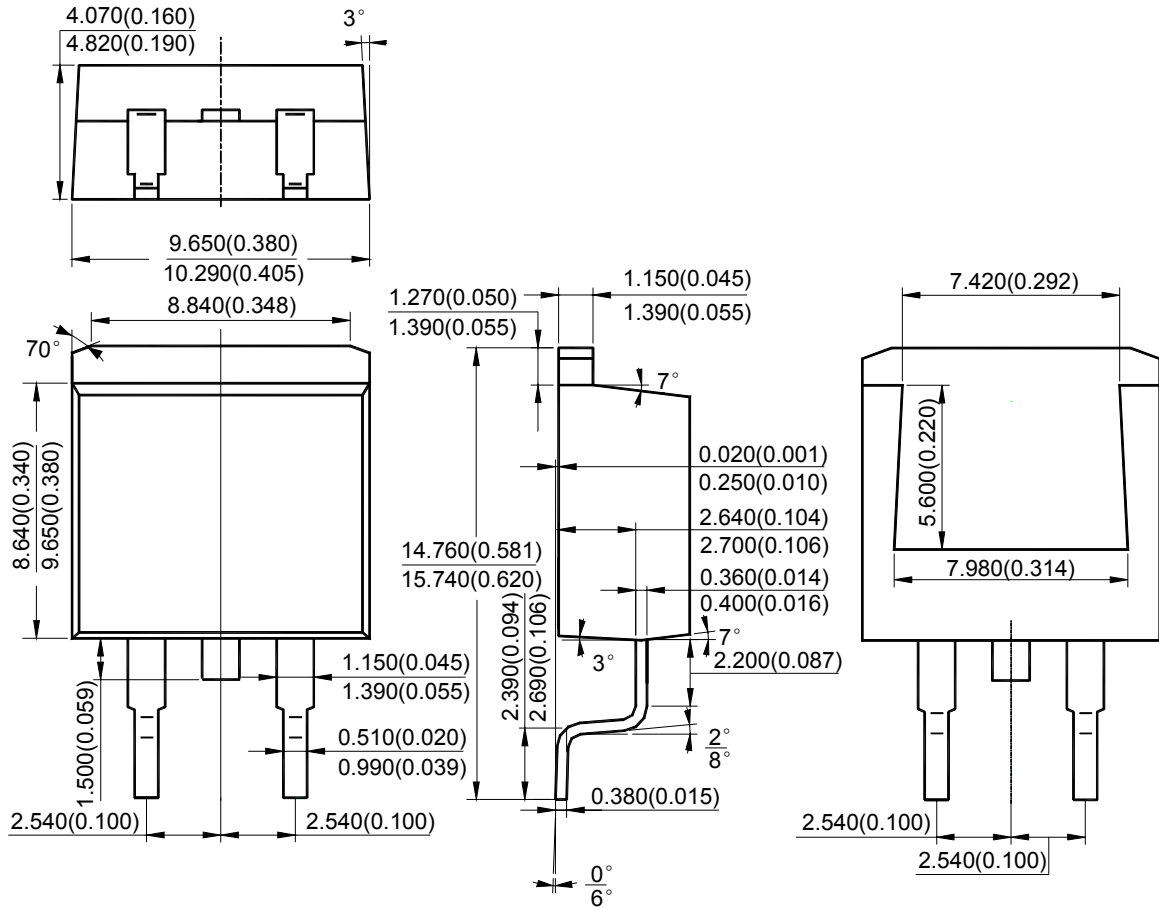



3A LOW DROPOUT LINEAR REGULATOR

AZ1085C

Mechanical Dimensions (Continued)

TO-252-2 (3)

Unit: mm(inch)

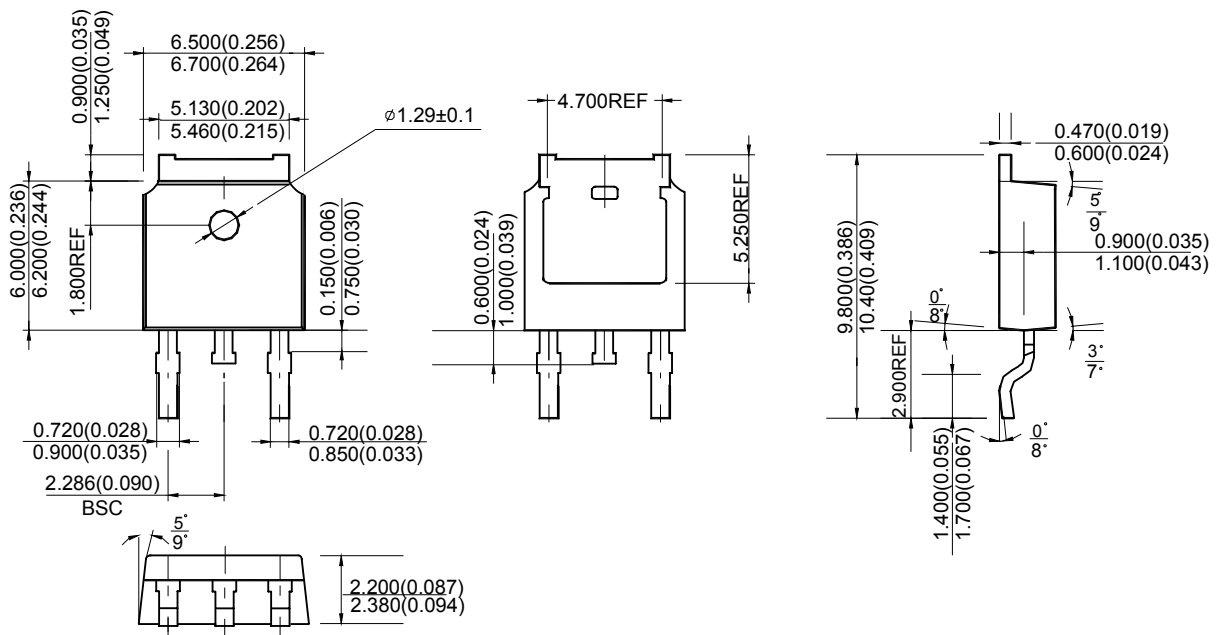



3A LOW DROPOUT LINEAR REGULATOR

AZ1085C

Mechanical Dimensions (Continued)

TO-252-2 (4)

Unit: mm(inch)

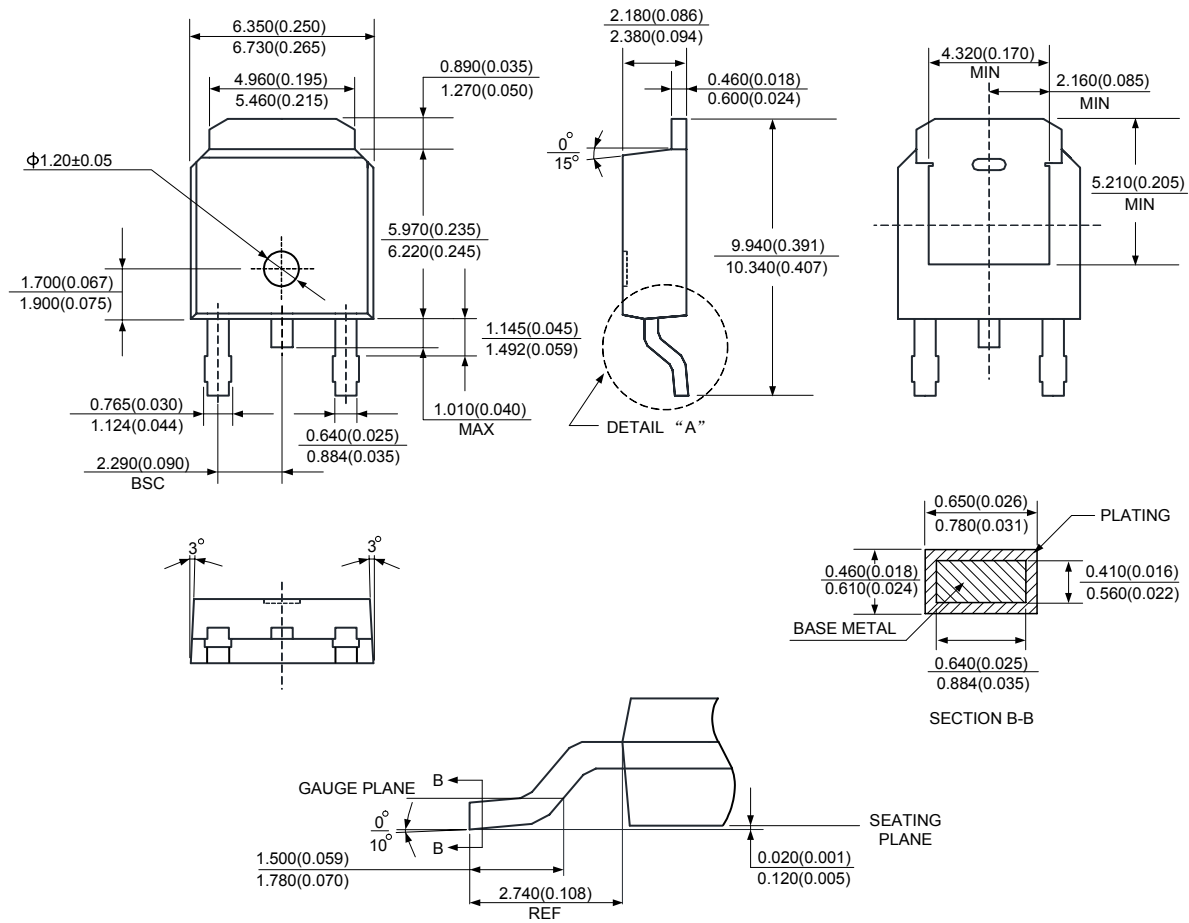



BCD Semiconductor Manufacturing Limited

<http://www.bcdsemi.com>

IMPORTANT NOTICE

BCD Semiconductor Manufacturing Limited reserves the right to make changes without further notice to any products or specifications herein. BCD Semiconductor Manufacturing Limited does not assume any responsibility for use of any its products for any particular purpose, nor does BCD Semiconductor Manufacturing Limited assume any liability arising out of the application or use of any its products or circuits. BCD Semiconductor Manufacturing Limited does not convey any license under its patent rights or other rights nor the rights of others.

MAIN SITE

- Headquarters

BCD Semiconductor Manufacturing Limited

No. 1600, Zi Xing Road, Shanghai ZiZhu Science-based Industrial Park, 200241, China
Tel: +86-21-24162266, Fax: +86-21-24162277

- Wafer Fab

Shanghai SIM-BCD Semiconductor Manufacturing Co., Ltd.

800 Yi Shan Road, Shanghai 200233, China
Tel: +86-21-6485 1491, Fax: +86-21-5450 0008

REGIONAL SALES OFFICE

Shenzhen Office

Shanghai SIM-BCD Semiconductor Manufacturing Co., Ltd., Shenzhen Office

Unit A Room 1203, Skyworth Bldg., Gaoxin Ave. 1.S., Nanshan District, Shenzhen, China
Tel: +86-755-8826 7951
Fax: +86-755-8826 7865

Taiwan Office

BCD Semiconductor (Taiwan) Company Limited

4F, 298-1, Rui Guang Road, Nei-Hu District, Taipei, Taiwan
Tel: +886-2-2656 2808
Fax: +886-2-2656 2806

USA Office

BCD Semiconductor Corp.

30920 Huntwood Ave. Hayward, CA 94544, USA
Tel : +1-510-324-2988
Fax: +1-510-324-2788