

Features

- Dual Zeners in Common Anode Configuration
- 300 mW Power Dissipation Rating
- Ideally Suited for Automated Insertion
- ΔV_Z For Both Diodes in One Case is $\leq 5\%$
- Common Cathode Style Available See DZ Series
- **Totally Lead-Free & Fully RoHS Compliant (Notes 1 & 2)**
- **Halogen and Antimony Free. "Green" Device (Notes 3 & 4)**
- **Qualified to AEC-Q101 Standards for High Reliability**

Mechanical Data

- Case: SOT23
- Case Material: Molded Plastic, "Green" Molding Compound. UL Flammability Classification Rating 94V-0
- Moisture Sensitivity: Level 1 per J-STD-020
- Terminals: Matte Tin Finish annealed over Alloy 42 leadframe (Lead Free Plating). Solderable per MIL-STD-202, Method 208 ③
- Polarity: See Diagram
- Approximate Weight: 0.008 grams

ESD Sensitivity Rating

- AEC-Q101, HBM - 8kV, MM - 400V
- IEC 61000-4-2, Air - 15kV, Contact - 8kV

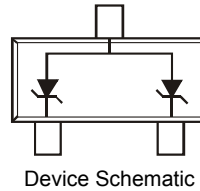

Ordering Information (Note 5)

Part Number	Qualification	Case	Packaging
(Type Number)-7-F*	Commercial	SOT23	3000/Tape & Reel
(Type Number)Q-7-F*	Automotive	SOT23	3000/Tape & Reel

*Add "-7-F" to the appropriate type number in Electrical Characteristics Table on Page 2 example: 6.2V Zener = AZ23C6V2-7F

- Notes:
1. No purposely added lead. Fully EU Directive 2002/95/EC (RoHS) & 2011/65/EU (RoHS 2) compliant.
 2. See <http://www.diodes.com> for more information about Diodes Incorporated's definitions of Halogen- and Antimony-free, "Green" and Lead-free.
 3. Halogen- and Antimony-free "Green" products are defined as those which contain <900ppm bromine, <900ppm chlorine (<1500ppm total Br + Cl) and <1000ppm antimony compounds.
 4. Product manufactured with Date Code V9 (week 33, 2008) and newer are built with Green Molding Compound. Product manufactured prior to Date Code V9 are built with Non-Green Molding Compound and may contain Halogens or Sb₂O₃ Fire Retardants.
 5. For Packaging Details, go to our website at <http://www.diodes.com>.

Marking Information

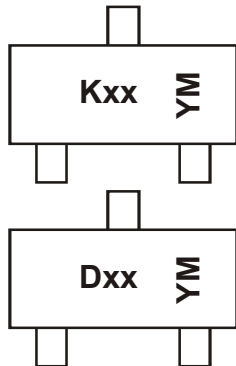

K/D = SAT (Shanghai Assembly / Test site)
 xx = Product Type Marking Code
 See Electrical Characteristics Table
 YM = Date Code Marking
 Y = Year (ex: Z = 2012)
 M = Month (ex: 9 = September)

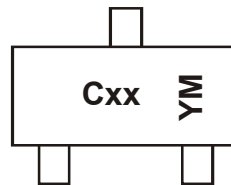

C = CAT (Chengdu Assembly / Test site)
 xx = Product Type Marking Code
 See Electrical Characteristics Table
 YM = Date Code Marking
 Y = Year (ex: Z = 2012)
 M = Month (ex: 9 = September)

Date Code Key

Year	1998	...	2002	2003	2004	...	2010	2011	2012	2013	2014	2015	2016	2017	2018
Code	J	...	N	P	R	...	X	Y	Z	A	B	C	D	E	F

Month	Jan	Feb	Mar	Apr	May	Jun	Jul	Aug	Sep	Oct	Nov	Dec
Code	1	2	3	4	5	6	7	8	9	O	N	D

Thermal Characteristics

Characteristic	Symbol	Value	Unit
Power Dissipation (Note 6)	P_D	300	mW
Thermal Resistance, Junction to Ambient Air (Note 6)	$R_{\theta JA}$	417	$^{\circ}C/W$
Operating and Storage Temperature Range	T_J, T_{STG}	-65 to +150	$^{\circ}C$

Notes: 6. Mounted on FR4 PC Board with recommended pad layout which can be found on our website at <http://www.diodes.com>.

Electrical Characteristics (@ $T_A = +25^{\circ}C$, unless otherwise specified.)

Type Number	Marking Code	Zener Voltage Range (Note 7)	Maximum Zener Impedance $f = 1kHz$		Typical Temperature Coefficient TC (%/ $^{\circ}C$)	Min. Reverse Voltage (Note 7) @ $I_R = 0.1\mu A$ V_R (Volts)
		@ $I_{ZT} = 5.0mA$	Z_{ZT} @ $I_{ZT} = 5.0mA$	Z_{ZK} @ $I_{ZK} = 1.0mA$		
		V_Z (Volts)	Ohms	Ohms		
AZ23C2V7	D1	2.5 - 2.9	83	500	-0.065	—
AZ23C3V0	D2	2.8 - 3.2	95	500	-0.060	—
AZ23C3V3	D3	3.1 - 3.5	95	500	-0.055	—
AZ23C3V6	D4	3.4 - 3.8	95	500	-0.055	—
AZ23C3V9	D5	3.7 - 4.1	95	500	-0.050	—
AZ23C4V3	D6	4.0 - 4.6	95	500	-0.035	—
AZ23C4V7	D7	4.4 - 5.0	78	500	-0.015	—
AZ23C5V1	D8	4.8 - 5.4	60	480	+0.005	0.8
AZ23C5V6	D9	5.2 - 6.0	40	400	+0.020	1.0
AZ23C6V2	DA	5.8 - 6.6	10	200	+0.030	2.0
AZ23C6V8	DB	6.4 - 7.2	8.0	150	+0.045	3.0
AZ23C7V5	DC	7.0 - 7.9	7.0	50	+0.050	5.0
AZ23C8V2	DD	7.7 - 8.7	7.0	50	+0.055	6.0
AZ23C9V1	DE	8.5 - 9.6	10	50	+0.065	7.0
AZ23C10	DF	9.4 - 10.6	15	70	+0.065	7.5
AZ23C11	DG	10.4 - 11.6	20	70	+0.070	8.5
AZ23C12	DH	11.4 - 12.7	20	90	+0.075	9.0
AZ23C13	DI	12.4 - 14.1	25	110	+0.080	10.0
AZ23C15	DJ	13.8 - 15.6	30	110	+0.080	11.0
AZ23C16	DK	15.3 - 17.1	40	170	+0.090	12.0
AZ23C18	DL	16.8 - 19.1	50	170	+0.090	14.0
AZ23C20	DM	18.8 - 21.2	50	220	+0.090	15.0
AZ23C22	DN	20.8 - 23.3	55	220	+0.090	17.0
AZ23C24	DO	22.8 - 25.6	80	220	+0.090	18.0
AZ23C27	DP	25.1 - 28.9	80	250	+0.090	20.0
AZ23C30	DQ	28 - 32	80	250	+0.090	22.5
AZ23C33	DR	31 - 35	80	250	+0.090	25.0
AZ23C36	DS	34 - 38	90	250	+0.090	27.0
AZ23C39	DT	37 - 41	90	300	+0.110	29.0
AZ23C43	30	40 - 46	100	700	+0.110	32.0
AZ23C47	31	44 - 50	100	750	+0.110	35.0
AZ23C51	32	48 - 54	100	750	+0.110	38.0

Notes: 7. Short duration pulse test used to minimize self-heating effect.

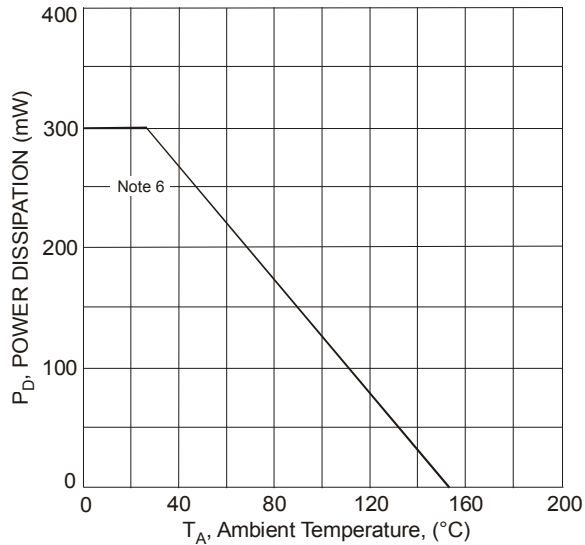

Fig. 1 Power Derating Curve

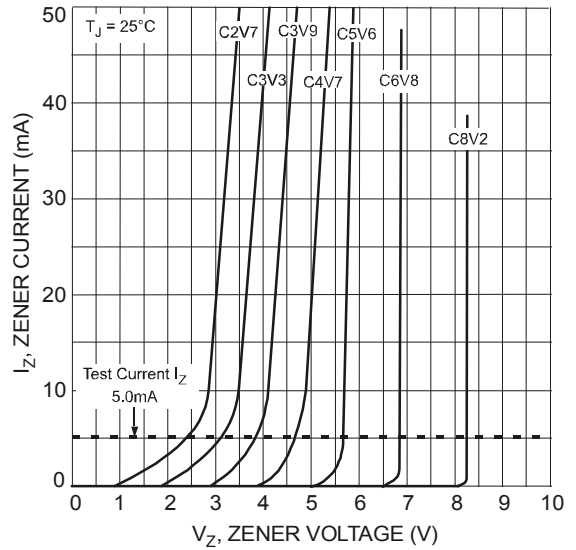

Fig. 2 Typical Zener Breakdown Characteristics

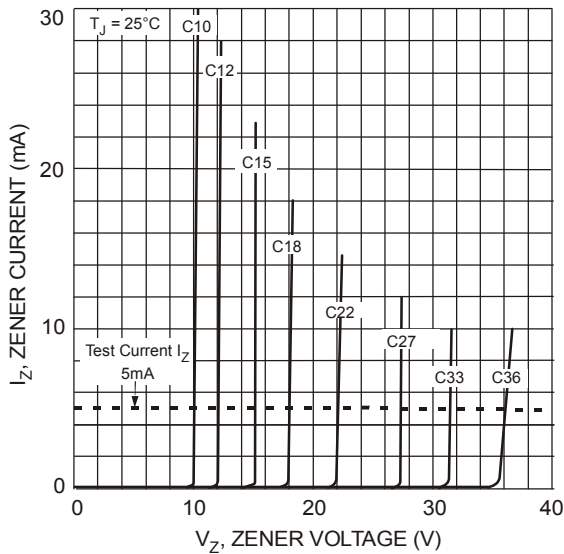

Fig. 3 Typical Zener Breakdown Characteristics

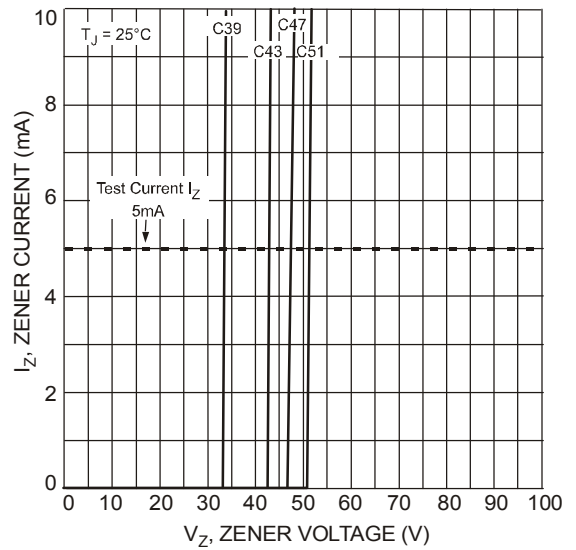

Fig. 4 Typical Zener Breakdown Characteristics

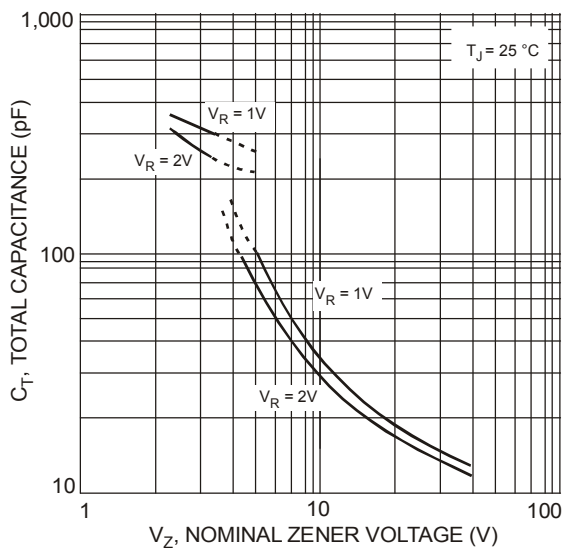
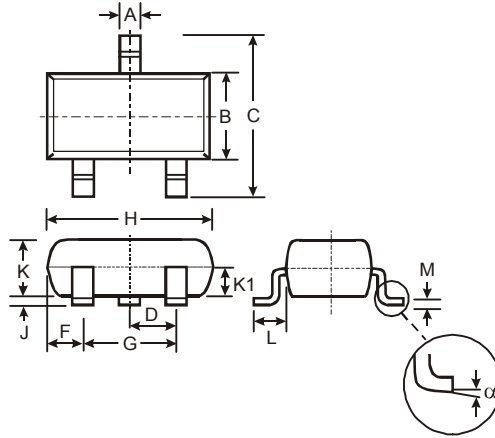

Fig. 5 Typical Total Capacitance vs. Nominal Zener Voltage

Package Outline Dimensions



SOT23			
Dim	Min	Max	Typ
A	0.37	0.51	0.40
B	1.20	1.40	1.30
C	2.30	2.50	2.40
D	0.89	1.03	0.915
F	0.45	0.60	0.535
G	1.78	2.05	1.83
H	2.80	3.00	2.90
J	0.013	0.10	0.05
K	0.903	1.10	1.00
K1	-	-	0.400
L	0.45	0.61	0.55
M	0.085	0.18	0.11
α	0°	8°	-
All Dimensions in mm			

Suggested Pad Layout

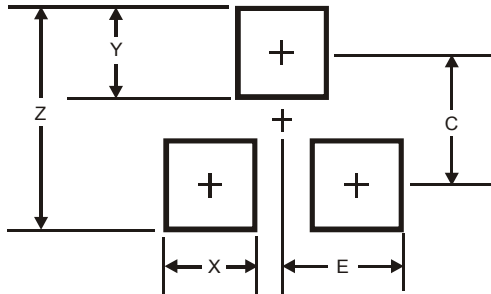

Dimensions	Value (in mm)
Z	2.9
X	0.8
Y	0.9
C	2.0
E	1.35

IMPORTANT NOTICE

DIODES INCORPORATED MAKES NO WARRANTY OF ANY KIND, EXPRESS OR IMPLIED, WITH REGARDS TO THIS DOCUMENT, INCLUDING, BUT NOT LIMITED TO, THE IMPLIED WARRANTIES OF MERCHANTABILITY AND FITNESS FOR A PARTICULAR PURPOSE (AND THEIR EQUIVALENTS UNDER THE LAWS OF ANY JURISDICTION).

Diodes Incorporated and its subsidiaries reserve the right to make modifications, enhancements, improvements, corrections or other changes without further notice to this document and any product described herein. Diodes Incorporated does not assume any liability arising out of the application or use of this document or any product described herein; neither does Diodes Incorporated convey any license under its patent or trademark rights, nor the rights of others. Any Customer or user of this document or products described herein in such applications shall assume all risks of such use and will agree to hold Diodes Incorporated and all the companies whose products are represented on Diodes Incorporated website, harmless against all damages.

Diodes Incorporated does not warrant or accept any liability whatsoever in respect of any products purchased through unauthorized sales channel. Should Customers purchase or use Diodes Incorporated products for any unintended or unauthorized application, Customers shall indemnify and hold Diodes Incorporated and its representatives harmless against all claims, damages, expenses, and attorney fees arising out of, directly or indirectly, any claim of personal injury or death associated with such unintended or unauthorized application.

Products described herein may be covered by one or more United States, international or foreign patents pending. Product names and markings noted herein may also be covered by one or more United States, international or foreign trademarks.

This document is written in English but may be translated into multiple languages for reference. Only the English version of this document is the final and determinative format released by Diodes Incorporated.

LIFE SUPPORT

Diodes Incorporated products are specifically not authorized for use as critical components in life support devices or systems without the express written approval of the Chief Executive Officer of Diodes Incorporated. As used herein:

A. Life support devices or systems are devices or systems which:

1. are intended to implant into the body, or
2. support or sustain life and whose failure to perform when properly used in accordance with instructions for use provided in the labeling can be reasonably expected to result in significant injury to the user.

B. A critical component is any component in a life support device or system whose failure to perform can be reasonably expected to cause the failure of the life support device or to affect its safety or effectiveness.

Customers represent that they have all necessary expertise in the safety and regulatory ramifications of their life support devices or systems, and acknowledge and agree that they are solely responsible for all legal, regulatory and safety-related requirements concerning their products and any use of Diodes Incorporated products in such safety-critical, life support devices or systems, notwithstanding any devices- or systems-related information or support that may be provided by Diodes Incorporated. Further, Customers must fully indemnify Diodes Incorporated and its representatives against any damages arising out of the use of Diodes Incorporated products in such safety-critical, life support devices or systems.

Copyright © 2013, Diodes Incorporated

www.diodes.com