

MP3-CD Soundmachine

AZ3830

User Manual
Manuel d'utilisation
Manual del usuario
Benutzerhandücher

Meet Philips at the Internet
<http://www.philips.com>

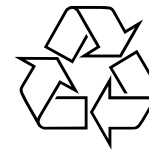

AZ3830

PHILIPS



Printed in China

JH-0634

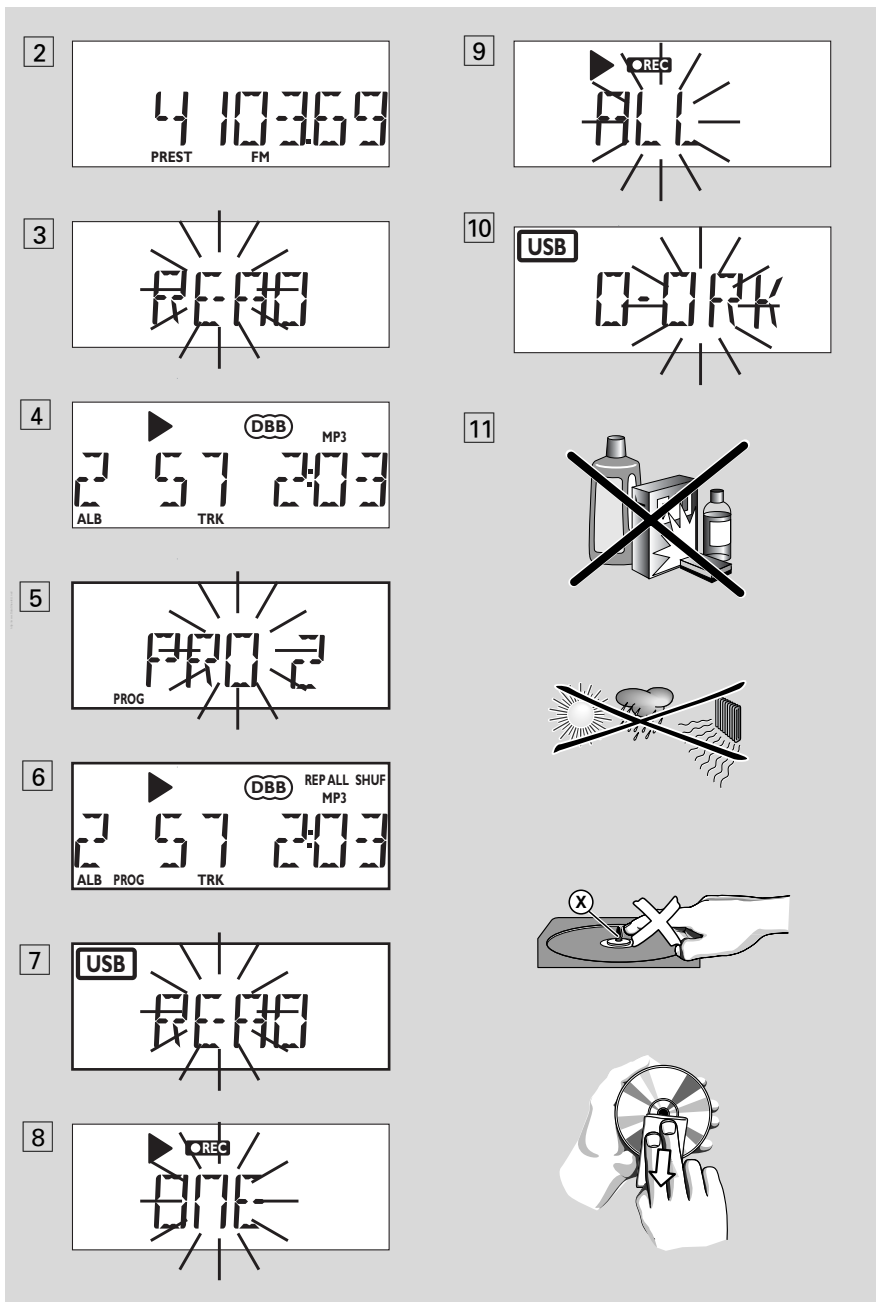
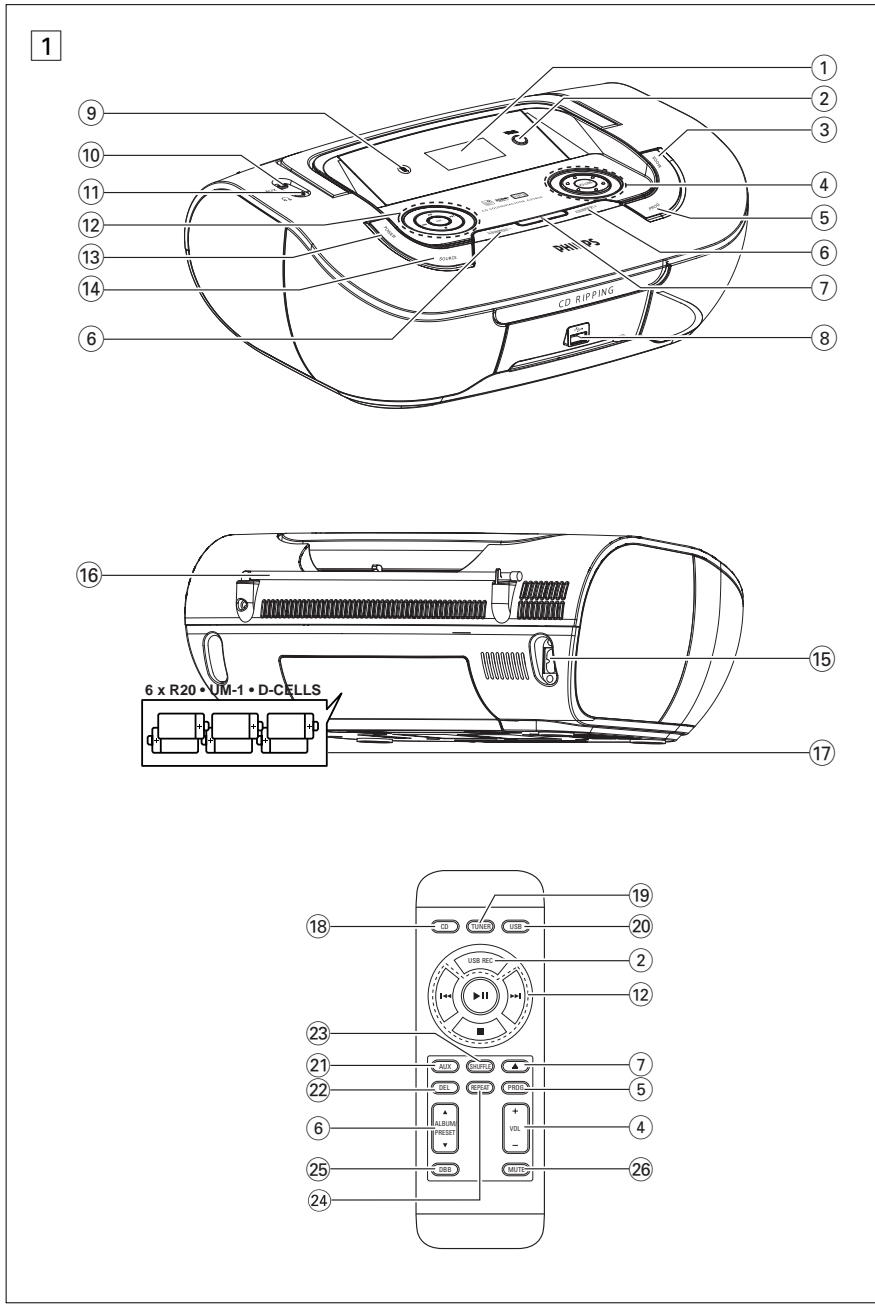

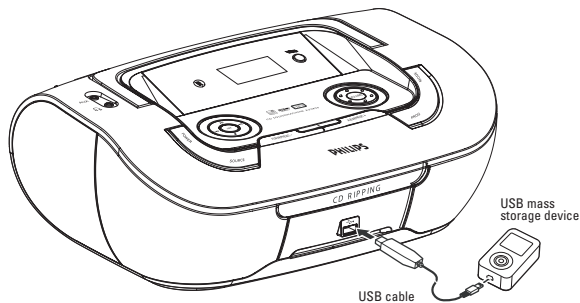
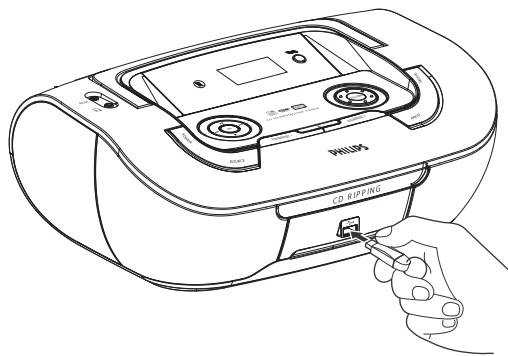
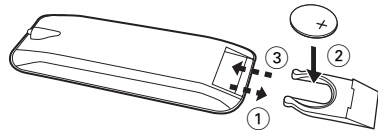
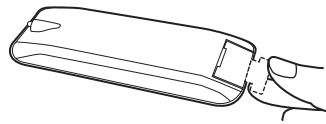

English

Supplied accessories

- AC power cord
- Remote control

Top and front panels (See 1)

- ① **Display** – shows the status of the set
- ② **USB REC** – copy one file or all files of a disc to an external portable USB storage device/MP3 player
- ③ **MODE** – selects different play modes: e.g. REPEAT or SHUFFLE (random order)
- ④ **VOLUME/VOL +/-** – adjusts volume level
- ⑤ **PROG**
 - For disc* – programs and reviews the program
 - For Tuner* – auto searches and stores radio stations
- ⑥ **ALBUM/PRESET +/- (▲, ▼)**
 - For MP3-CD/ WMA/USB play:* – select albums
 - For Tuner* – selects a preset radio station
- ⑦ **▲** – opens/closes the disc tray
- ⑧ **USB port** – connects an external USB mass storage device
- ⑨ **iR** – infrared sensor for remote control
- ⑩ **AUX jack** – connects an external source (3.5 mm socket)
- ⑪ **🎧** – 3.5 mm stereo headphone socket
 - Helpful hints: The speakers will be muted when headphones are connected to the set.*
- ⑫ **▶||** – starts or pauses disc/USB playback
 - ◀◀ ▶▶**
 - For disc/ USB play:*
 - skips to the beginning of a current/ previous/ later track
 - fast searches backwards and forwards within a track

Controls / Power Supply

For Tuner:

- tunes to a radio station
- – stops disc/USB playback;
 - erases a program

DBB – turns on/off bass enhancement

- ⑬ **POWER** – powers on/off the system
- ⑭ **SOURCE:** – selects CD/MP3-CD, USB mode, Tuner or AUX

Back panel (See 1)

- ⑮ **AC~ MAINS** – inlet for power cord
- ⑯ **Telescopic antenna** – improves FM reception
- ⑰ **Battery door** – opens to insert 6 x 1.5V R-20/ -UM1/ D-cells

Remote control (See 1)

- ⑱ **CD** – selects disc mode
- ⑲ **TUNER** – selects tuner mode
- ⑳ **USB** – selects USB mode
- ㉑ **AUX** – selects AUX mode
- ㉒ **DEL** – deletes one file or all files stored on the external USB device
- ㉓ **SHUFFLE** – turns on/off the random play mode
- ㉔ **REPEAT** – repeats a track/disc/all programmed tracks
- ㉕ **DBB** – turns on/off bass enhancement
- ㉖ **MUTE** – mutes or restores the volume

Power Supply

Whenever convenient, use the power supply cord if you want to conserve battery life. Make sure you remove the plug from the set and wall outlet before inserting batteries.

Batteries

Main set (See 1)

- Insert **6** batteries, type **R-20, UM1** or **D-cells** (not included, preferably alkaline) with the correct polarity.

Power Supply

Remote control

Important!

- **Before using the remote control, remove the insulation plastic tab as shown in figure 12.**
- **If the remote control does not function correctly or the operating range is reduced, replace the battery with a new (CR2025) type battery.**

- 1 Pull the battery tray out as shown in figure 12.
- 2 Replace a new battery according to polarity indication, and fully insert the battery tray back to the original position.
- Incorrect use of batteries can cause electrolyte leakage and will corrode the compartment or cause the batteries to burst:
- Do not mix battery types: e.g. alkaline with carbon zinc. Only use batteries of the same type for the set.
- When inserting new batteries, do not try to mix old batteries with the new ones.
- Remove the batteries if the set is not to be used for a long time.

Batteries contain chemical substances, so they should be disposed of properly.

Using AC power

- 1 Check if the power/mains voltage, **as shown on the type plate located on the bottom of the set**, corresponds to your local power supply. If it does not, consult your dealer or service center.
- 2 Connect the power cord to the **AC~ MAINS** inlet and the wall socket. The set is now ready for use.
- 3 To switch the set off completely, withdraw the power cord from the wall socket.
- 4 Install the unit near the AC outlet and where the AC power plug can be easily reached.

- Disconnect the power cord from the wall socket to protect your set during heavy thunderstorms. Children could seriously injure themselves as the free end of the cable may still be live if only the connector is removed from the MAINS socket at the back of the unit.

The type plate is located on the bottom of the set.

Auto power saving

- When the **source selector** is adjusted to **CD/USB** and the set is in the PAUSE position for 5 minutes, the set will be auto switched to the stop position to save power.
- When the **source selector** is adjusted to **CD/USB** and the set is in the STOP position for 15 minutes, the set will auto switch off.

Helpful hints:

- To avoid unnecessary energy consumption, always press **POWER** on the set to power off the set after using the set.

CAUTION

-Visible and invisible laser radiation. If the cover is open, do not look at the beam.

- High voltage! Do not open. You run the risk of getting an electric shock. The machine does not contain any user-serviceable parts.

- Modification of the product could result in hazardous radiation of EMC or other unsafe operation.

This set complies with the radio interference requirements of the European Union.

Basic Function/ Radio

Basic functions

Switching on/off the set

- 1 To switch on, press **POWER**.
→ Display lights up. The system will switch to the last selected source.
- 2 To switch off, press **POWER** again.
→ Display lights off.

Adjusting volume and sound

Adjust the sound with the **VOLUME** and **DBB** controls.

Digital tuner

Tuning to radio stations

- 1 Press repeatedly **SOURCE** (or **TUNER** on the remote control) to select **FM** or **MW**.
→ "TUNER" is displayed briefly, then the radio station frequency, waveband and, if programmed, a preset number are shown (See 2).
 - 2 Press and hold **◀** or **▶** until the frequency in the display starts running.
→ The radio automatically tunes to a station of sufficient reception. Display shows "SEARCH" during automatic tuning.
 - 3 Repeat step 2 if necessary until you find the desired station.
- To tune to a weak station, press **◀** or **▶** briefly and repeatedly until you have found optimal reception.

To improve radio reception:

- For **FM**, extend, incline and turn the telescopic aerial. Reduce its length if the signal is too strong.
- For **MW**, the set uses a built-in aerial. Direct this aerial by turning the whole set.

Programming radio stations

You can store 15 FM and 10 MW radio stations in the memory manually or automatically (Auto store).

MP3-CD/ CD Player

Manual programming

- 1 Tune to your desired station (see **Tuning to radio stations**).
- 2 Press **PROG** to activate programming.
→ Display: **PROG** flashes.
- 3 Press **ALBUM/PRESET +/-** (**ALBUM/PRESET ▲, ▼** on the remote control) once or more to allocate a number (FM: from 1 to 15; MW: from 1 to 10).
- 4 Press **PROG** to confirm.
- 5 Repeat steps 1-4 to store other stations.

Helpful hints:

- You can erase a preset station by storing another frequency in its place.

Autostore

Autostore automatically starts programming radio stations from preset 1. Any previous presets e.g. manually programmed will be erased.

- 1 Press repeatedly **SOURCE** (or **TUNER** on the remote control) to select **FM** or **MW**.
- 2 Press **PROG** until "AUTO" flashes.
→ Available stations are programmed (MW or FM). After all stations are stored, the first autostore preset station will then automatically play.

To listen to a preset or autostore station

Press the **ALBUM/PRESET +/-** (**ALBUM/PRESET ▲, ▼** on the remote control) buttons once or more until the desired preset station is displayed.

MP3-CD/ CD Player

About MP3

The music compression technology MP3 (MPEG1 Audio Layer 3) significantly reduce the digital data of an audio CD while maintaining CD quality sound.

- **Getting MP3 files:** you can either download legal music files from the internet to your computer hard disc, or create such files by converting audio CD files in your computer through appropriate encoder software. (128kbps bit rate or higher is recommended for MP3 files.)
- **Creating a MP3 CD:** burn the music files from your computer hard disc on a CDR or CDRW using your CD burner.

Helpful hints:

- Make sure that the file names of the MP3 files end with **.mp3** or **.wma**.
- Number of albums: maximum 100.
- Number of tracks: maximum 999.
- The length of file names affects the number of tracks for playback. With shorter file names, more files can be burned on a disc.

Playing a disc

This player plays Audio Discs including CD-R/CD-RW, MP3 CD and WMA. Do not try to play a CD-ROM, CD-I, CDV, VCD, DVD or computer CD.

IMPORTANT!

- CDs encoded with **copyright protection technologies** by some record companies may be unplayable by this product.
 - DRM-protected WMA disc is not supported.
- 1 Press repeatedly **SOURCE (CD)** on the remote control) to select CD source.
→ Display shows flashing "READ" if CD source is selected (see [3]).

→ " NO CD" will be displayed if CD is not loaded.

- 3 Press **▲** to open the disc door.
- 4 Insert a disc with the printed side facing up and press the disc door gently to close.
→ The disc scanning of MP3-CD may run longer than audio CD.
→ Display: The total number of tracks appears (and album number for MP3/WMA) (see [4]).
- 5 Press **▶▶** to start playback.
→ First the song title of the track scrolls across the display, then the track number and the elapsed playing time are displayed.

For MP3-CD/ WMA only:

→ The current track number (**TRK**) and album number (**ALB**) will be displayed interchangeably.

- 6 To pause playback press **▶▶**.
→ Display: **▶** and the elapsed playing time flash.
- 7 Press **▶▶** again to resume playback.
- 8 To stop playback, press **■**.

Helpful hints:

- The disc playback will also stop when:
- you open the disc compartment door;
 - you select **FM, MW** or **AUX**;
 - the disc has reached the end of the playback.

Selecting a different track

- Press **◀◀** or **▶▶** once or repeatedly until the desired track number appears in the display.
- For MP3-CD/WMA:** First press **ALBUM/PRESET +/- (ALBUM/PRESET ▲, ▼)** on the remote control) once or more to find your album.
- In the pause/stop position, press **▶▶** to start playback.

MP3-CD/ CD Player

Finding a passage within a track

- 1 During playback, press and hold down **◀◀** or **▶▶**.
→ The disc is played at high speed and low volume.
- 2 When you recognize the passage you want, release **◀◀** or **▶▶**.
→ Normal playback resumes.

Programming tracks

You may store up to 20 tracks in the desired sequence. If you like, store any track more than once.

- 1 In the stop position, press **◀◀** or **▶▶** to select your desired track number.
- **For MP3-CD/WMA:** First press **ALBUM/PRESET +/- (ALBUM/PRESET ▲, ▼)** on the remote control) once or more to find your album.
- 2 Press **PROG** to store tdesired track.
→ Display shows "PRO 2" , indicating the next program location available (See [5]).
- If you attempt to program without first selectig a track, display will show "SELECT TRARCK" briefly, then the total track number and playing time.
- 3 Repeat steps **1 to 2** to select and store all desired tracks.
- 4 Press **▶▶** to play the program.
→ "PROG" is dispalyed during program playback.

To review your program

- In the stop position, press and hold **PROG** 3 seconds.
- The display shows all the stored tracks (and album numbers for MP3) in sequence.

Helpful hints:

- Display shows "PRO 1" if no track is programmed.
- If you try to store more than 20 tracks, no track can be stored and the display will show "PROGRAM FULL".

To erase a program

You can erase a program by:

- pressing **■** (twice during playback or once in the stop position);
- selecting **FM, MW** or **AUX**;
- pressing **POWER** to power off;
- opening the disc door.
→ "PROGRAM CLEAR" scrolls across the display once, and "PROG" disappears.

Selecting different play modes (See [6])

You can select and change the various play modes before or during playback, and combine play modes with **PROG**.

REP – plays the current track continuously.
REP ALL – plays the entire disc/program continuously.

SHUF – plays all tracks in random order.
REP ALL SHUF – plays all tracks in random order continuously.

- 1 To select play modes, press **MODE** on the set (**REPEAT** or **SHUFFLE** on the remote control) once or more.
- 2 Press **▶▶** to start playback if in the stop position.
→ Shuffle play will start automatically soon after shuffle mode is selected.
- 3 To select normal playback, press **MODE** on the set (**REPEAT** or **SHUFFLE** on the remote control) repeatedly until the various play modes are no longer displayed.
– You can also press **■** to cancel your play modes.

MP3-CD/ CD Player

Using USB connectivity

- AZ3830 is fitted with a USB port in the front panel, offering a plug and play feature which allows you to play, from your AZ3830, digital music and spoken contents stored on a USB mass storage device.
- Using a USB mass storage device, you can also enjoy all the features offered by AZ3830 which are explained and instructed in the sections of disc operation.

Compatible USB mass storage devices

With the AZ3830, you can use

- USB flash memory (USB 2.0 or USB 1.1)
- USB flash player (USB 2.0 or USB 1.1)
- USB device which requires driver installation under Windows XP is not supported.

Note:

In some USB flash players (or memory devices), the stored contents are recorded using copyright protection technology. Such protected contents will be unplayable on any other devices (such as AZ3830 device).

Supported formats:

- USB or memory file format FAT12, FAT16, FAT32 (sector size: 512 - 4096 bytes)
- MP3 bit rate (data rate): 32-320 kbps and variable bit rate
- WMA v9 or earlier
- Directory nesting up to a maximum of 8 levels
- Number of albums: maximum 100
- Number of tracks: maximum 999
- ID3 tag v2.0 or later
- File name in Unicode UTF8 (maximum length: 128 bytes)

USB Connection

The system will not play or support the following:

- Empty albums: an empty album is an album that does not contain MP3/WMA files, and will not be shown in the display.
- Non-supported file formats are skipped. This means that e.g.: Word documents .doc or MP3 files with extension .dlf are ignored and will not be played.
- AAC, WAV, PCM, NTFS audio files
- DRM protected WMA files
- WMA files in Lossless format

Playing a USB mass storage device

- 1 Make sure that your AZ3830 is being powered by AC mains or specified batteries.
- 2 Press repeatedly **SOURCE** (or **USB** on the remote control) to select **USB** mode.
→ Display shows "USB", indicating the set is in USB mode (see [7]).
- 3 As shown in figure [12], plug a compatible USB mass storage device to AZ3830's USB port marked . If needed, use a suitable USB cable to connect between the device and AZ3830's USB port.
→ The device will automatically power on.
- If the device is not powered on, turn on the power manually, then re-connect it.
→ AZ3830's display shows USB and the total number of playable audio files (Max. displayed track number is 999) stored on the device.
- 4 Press **▶||** on your AZ3830 to start play.
→ AZ3830's display will show USB and share the display information illustrated in the disc operation.

Helpful hints:

- Make sure that file names of MP3 files end with .mp3, and the file names of WMA files end with .wma.
- For DRM protected WMA files, use Windows Media Player 10 (or later) for conversion. Visit www.microsoft.com for details about Windows Media Player and WM DRM (Windows Media Digital Rights Management).

USB Connection

CD Ripping - Recording disc files to a USB device

AZ3830 allows you to copy the music files or spoken contents of a disc to the external USB device. You can record one track, the whole disc or even selected tracks through the Program function.

- 1 Press repeatedly **SOURCE** (or **USB** on the remote control) to select **USB** mode.
- 2 Insert a disc (audio CD or MP3 or WMA). If desired, program the disc.
- 3 Plug a USB mass storage device.

To record one

- 4a Press the track you want to record.
- 4b Press once or repeatedly **USB REC** until "RIPPING ONE" appears, flashing.
→ Disc playback will start automatically from the beginning of the selected track.
→ "REC" is displayed flashing, and "RIPPING ONE" will flash 2 seconds, then disappear (see [8]).

To record all

- 4a Press repeatedly **USB REC** until "RIPPING ALL" appears, flashing.
→ Disc playback will start automatically from the beginning.
→ "REC" and "ALL" are displayed flashing, and "RIPPING ALL" will flash 2 seconds, then disappear (see [9]).
- 5 To stop recording, first press **■**, then unplug the USB device.
- In the record-one mode, the playback will auto go to the stop position after one track/file comes to an end.
- During MP3 and WMA recording, make sure the playback of the file you want to record is wholly completed before manually stop recording. Or any part of the file will not be recorded.
- During recording, if the memory of the USB device runs out, playback will not continue.

Helpful hints:

- In recording mode (even the USB device is unplugged from the set), selections of track/album, play modes (repeat and shuffle modes) are not available.
- All the recorded audio files will be stored in the folder named **_PHILIPS** which is automatically created for recording.
- The recorded audio file will be stored in either **.mp3** format (for the disc of audio or MP3), or **.wma** format (for WMA disc).
- Copyright-protected CD will not be recorded.
- DRM-protected WMA is not supported.
- Do not directly unplug the USB device to stop recording for a possible loss of some of the recorded contents.
- For MP3 and WMA recording, if the name of a file to be recorded is the same as the one of a file stored in the USB device, the file will not be recorded. In this case, AZ3830's display will show flashing *E-r-r* and *d-u-p* interchangeably 3 seconds.
- For some USB device of low speed, the playback may go with muted sound for some seconds which will depend on the capability of the low-speed USB device.

Important notes for users in the U.K.

Mains plug

This apparatus is fitted with an approved 13 Amp plug. To change a fuse in this type of plug proceed as follows:

1. Remove fuse cover and fuse.
2. Fix new fuse which should be a BS1362 3 Amp, A.S.T.A. or BSI approved type.
3. Refit the fuse cover.

If the fitted plug is not suitable for your socket outlets, it should be cut off and an appropriate plug fitted in its place. If the mains plug contains a fuse, this should have a value of 3 Amp. If a plug without a fuse is used, the fuse at the distribution board should not be greater than 3 Amp.

Note: The severed plug must be disposed of to avoid a possible shock hazard should it be inserted into a 13 Amp socket elsewhere.

How to connect a plug

The wires in the mains lead are coloured with the following code: blue = neutral (N), brown = live (L). As these colours may not correspond with the colour markings identifying the terminals in your plug, proceed as follows:

- Connect the blue wire to the terminal marked N or coloured black.
- Connect the brown wire to the terminal marked L or coloured red.
- Do not connect either wire to the earth terminal in the plug, marked E (or e) or coloured green (or green and yellow).

Before replacing the plug cover, make certain that the cord grip is clamped over the sheath of the lead - not simply over the two wires.

Copyright in the U.K.

Recording and playback of material may require consent. See Copyright Act 1956 and The Performer's Protection Acts 1958 to 1972.

USB Connection

Deleting audio files on a USB device

- 1 Press repeatedly **SOURCE** (or **USB** on the remote control) to select **USB** mode.
- 2 Plug a USB mass storage device.
- 3 Select the track you want to delete before or during playback.
 - In the stop position, you may select an album to delete.
- 4 Briefly press **DEL** on the remote control. → "D TRK" is displayed, flashing (see 10).
- 5 To not to delete, wait until flashing D TRK disappears after 4 seconds of flashing, or just press **■**.

The making of unauthorized copies of copy-protected material, including computer programmes, files, broadcasts and sound recordings, may be an infringement of copyrights and constitute a criminal offence. This equipment should not be used for such purposes.



Auxiliary connection

Helpful hints:

- For some MP3 players, AZ3830 will read it as only one folder which will wrap up all the audio files on the player regardless of more than one folder on that player.
- AZ3830 may not be able to delete a file / album stored on some MP3 players.

Connecting an external device

You can listen to the sound of the connected external device through your AZ3830's speakers.

- 1 Press repeatedly **SOURCE** (or **AUX** on the remote control) to select **AUX** mode.
- 2 Use a line-in cable (not supplied) to connect AZ3830's AUX jack (3.5 mm, located on the top panel) to an AUDIO OUT or headphone jack on an external equipment (such as CD player, or VCR).

Disposal of your old product

Your product is designed and manufactured with high quality materials and components, which can be recycled and reused.

When this crossed-out wheeled bin symbol is attached to a product it means the product is covered by the European Directive 2002/96/EC.



Please inform yourself about the local separate collection system for electrical and electronic products.

Please act according to your local rules and do not dispose of your old products with your normal household waste. The correct disposal of your old product will help prevent potential negative consequences for the environment and human health.

Safety & Maintenance (See 11)

Safety information

- Place the set on a hard, flat and stable surface so that the system does not tilt.
- Do not expose the set, batteries, CDs to humidity, rain, sand or excessive heat caused by heating equipment or direct sunlight.
- The apparatus shall not be exposed to dripping or splashing.
- Adequate ventilation with a minimum gap of 15 cm between the ventilation holes and surrounding surfaces is necessary to prevent heat build-up.
- The ventilation should not be impeded by covering the ventilation openings with items, such as newspapers, table-cloths, curtains, etc..
- No objects filled with liquids, such as vases, shall be placed on the apparatus.
- No naked flame sources, such as lighted candles, should be placed on the apparatus.
- The mechanical parts of the set contain self-lubricating bearings and must not be oiled or lubricated.
- To clean the set, use a dry cloth. Do not use any cleaning agents containing alcohol, ammonia, benzene or abrasives as these may harm the housing.

CD player and CD handling

- If the CD player cannot read CDs correctly, use a cleaning CD to clean the lens before taking the set to repair.
- The lens of the CD player should never be touched!
- Sudden changes in the surrounding temperature can cause condensation on the lens of your CD player. Playing a CD is then not possible. Do not attempt to clean the lens but leave the set in a warm environment until the moisture evaporates.
- Always close the CD door to avoid dust on the lens.
- To clean the CD, wipe in a straight line from the center towards the edge using a soft, lint-free cloth. Do not use cleaning agents as they may damage the disc.
- Never write on a CD or attach any stickers to it.

Troubleshooting

If a fault occurs, first check the points listed below before taking the set for repair. If you are unable to remedy a problem by following these hints, consult your dealer or service centre.

WARNING: Do not open the set as there is a risk of electric shock. Under no circumstances should you try to repair the set yourself, as this will invalidate the guarantee.

No sound/ power

- Volume not adjusted
- Adjust the VOLUME
- Power cord not securely connected
- Connect the AC power cord properly
- Batteries dead/ incorrectly inserted
- Insert (fresh) batteries correctly
- Disc contains non-audio files
- Insert a suitable disc or press ◀◀ or ▶▶ once or more skip to an audio track, instead of the data files.

Display does not function properly/No reaction to operation of any of the controls

- Electrostatic discharge
- Switch off and unplug the set. Reconnect after a few seconds.

no indication

- It is set in the USB mode.
- Press repeatedly **SOURCE (CD)** on the remote control) to select CD source.
- No disc inserted
- Insert a suitable disc
- Disc badly scratched or dirty
- Replace/clean CD (See Maintenance)
- CD-R(W) is blank or the disc is not finalized.
- Use a finalized CD-R(W)
- Laser lens steam up
- Wait until lens has cleared.

Note:

Make sure the CD is not encoded with Copyright protection technologies, as some do not conform to the Compact Disc standard.

The disc skips tracks

- Disc damaged or dirty
- Replace or clean disc
- Shuffle or program is active
- Switch off shuffle/program

Sound skips during MP3 playback

- MP3 file made at compression level exceeding 320kbps
- Use a lower compression level to record CD tracks into MP3 format
- Disc damaged or dirty
- Replace or clean disc.

Note:

DRM-protected WMA disc is not supported.

The USB device doesn't play on my AZ3830

- It is not set in the USB mode.
- Press repeatedly **SOURCE** (or **USB** on the remote control) to select **USB** mode.
- The device is not securely connected to AZ3830's USB port.
- Re-connect the device, and make sure that the device is powered on.
- The device is not supported by AZ3830, or the audio file format stored on the device is not supported by AZ3830.
- Use a compatible device/ playable audio file format.

The disc file cannot be recorded to the USB device

- You stop recording when the MP3 or WMA file you want to record is still playing.
- Select record-one mode to record, or stop recording only when the playback of MP3 or WMA file is wholly completed.
- The memory of the USB device runs out.
- Delete some unwanted files on the USB device to free some memory, or use another USB device of sufficient free memory to record.
- The name of a MP3 or WMA file on the disc is identical to the one of a file on the USB device.
- Change to a different name for the file on the USB device.

Depistage des Anomalies

Si une erreur se produit, contrôlez d'abord les points indiqués dans la liste ci-dessous avant d'emmener l'appareil chez le réparateur. Si vous ne parvenez pas à remédier aux problèmes à partir de ces indications, consultez votre concessionnaire ou le centre de service après-vente.

ATTENTION: *Ne jamais ouvrir vous-même l'appareil au risque de recevoir des chocs électriques. N'essayez en aucun cas de réparer vous-même l'appareil, car ceci vous ferait perdre le droit à la garantie.*

Pas de tonalité/puissance

- VOLUME non réglé
- Réglez le VOLUME
- Cordon d'alimentation mal branché
- Branchez correctement le cordon d'alimentation
- Piles à plat/ incorrectement insérées.
- Insérez de nouvelles piles correctement
- Le CD contient des fichiers autres que audio
- Introduisez un disque suitable ou appuyez une fois ou répétitivement sur ◀ ou ▶ pour passer à une piste CD audio, au lieu d'un fichier de données.

L'affichage ne fonctionne pas adéquatement/ aucune réaction à l'agissement sur l'une des commandes

- Décharge électrostatique
- Mettez l'appareil hors service et débranchez la fiche secteur. Rebranchez au bout de quelques secondes.

Indication

- Le mode USB est sélectionné.
- Appuyez plusieurs fois sur la touche **SOURCE** (ou la touche **CD** de la télécommande) pour sélectionner la source CD.
- Pas de CD dans l'appareil
- Insérez un CD
- CD griffé/contaminé
- Remplacez ou nettoyez le CD, voir Entretien
- Lentille laser embuée
- Attendez jusqu'à ce que la lentille soit claire
- CD-R/CD-RW est vierge ou le CD n'a pas été reconnu
- Utilisez un CD-R/CD-RW reconnu

Remarque:

Assurez-vous que vos CD n'ont pas été codés à l'aide de telles technologies car certaines ne sont pas compatibles avec la norme Compact Disc.

Le CD saute

- CD endommagé ou contaminé
- Remplacez ou nettoyez le disque
- shuffle ou program sont actives
- Désactivez shuffle / program

Interruptions sonores en cours de lecture MP3

- Le fichier MP3 a été créé à un niveau de compression excédant 320kbps.
- Utilisez un niveau de compression inférieur pour enregistrer vos pistes CD sous le format MP3.
- CD endommagé ou contaminé
- Remplacez/nettoyez le CD.

Le périphérique USB ne fonctionne pas sur mon AZ3830.

- Le mode USB n'est pas sélectionné.
- Appuyez plusieurs fois sur la touche **SOURCE** (ou la touche **USB** de la télécommande) pour sélectionner la source USB.
- Le périphérique n'est pas connecté correctement au port USB du AZ3830.
- Connectez de nouveau le périphérique, et assurez-vous que le périphérique est alimenté.
- Le périphérique n'est pas supporté par l'AZ3830, ou le format du fichier audio stocké sur le périphérique n'est pas supporté par l'AZ3830.
- Utilisez un périphérique/format de fichier audio compatible.

Il est impossible d'enregistrer ce fichier CD sur le périphérique USB.

- Vous avez interrompu l'enregistrement alors que le fichier MP3 ou WMA que vous souhaitez enregistrer est en cours de lecture.
- Sélectionnez le mode d'enregistrement d'une seule piste pour effectuer l'enregistrement ou arrêtez l'enregistrement uniquement lorsque la lecture du fichier MP3 ou WMA est terminée.
- La mémoire du périphérique USB est presque saturée.
- Supprimez certains fichiers superflus du périphérique USB pour libérer de l'espace mémoire ou utilisez un autre périphérique USB.
- Le nom d'un fichier MP3 ou WMA du CD est identique à celui situé sur le périphérique USB.
- Modifiez le nom du fichier situé sur le périphérique USB.