

**DUAL LOW VOLTAGE RAIL-TO-RAIL OUTPUT OPERATIONAL AMPLIFIERS**

DATA SHEET

**Description**

The AZV358 is dual low voltage (2.7V to 5.5V) operational amplifiers which have rail-to-rail output swing capability. The input common-mode voltage range includes ground. The chip exhibits excellent speed-power ratio, achieving 1MHz of bandwidth and 1V/ $\mu$ s of slew rate with low supply current.

The AZV358 is built with BiCMOS process. It has bipolar input and output stages for improved noise performance, low input offset voltage and higher output current drive.

AZV358 is available in the package of TSSOP-8 and MSOP-8. The small packages save space on pc boards, and enable the design of small portable electronic devices. It also allows the designer to place the device closer to the signal source to reduce noise pickup and increase signal integrity.

AZV358 is also available in standard SOIC-8 package.

**Features**

- (For  $V_{CC}=5V$  and  $V_{EE}=0V$ , typical unless otherwise noted)
- Guaranteed 2.7V to 5.5V Performance
  - No Crossover Distortion
  - Gain-Bandwidth Product 1MHz
  - Industrial Temperature Range:  $-40^{\circ}C$  to  $+85^{\circ}C$
  - Low Supply Current: 210 $\mu$ A
  - Rail-to-Rail Output Swing under 10k $\Omega$  Load:
    - $V_{OH}$  up to  $V_{CC} - 10mV$
    - $V_{OL}$  near to  $V_{EE} + 65mV$
  - $V_{CM}$ : -0.1V to  $V_{CC} - 0.8V$

**Pin Assignments**

M/G/MM Package  
(SOIC-8/TSSOP-8/MSOP-8)

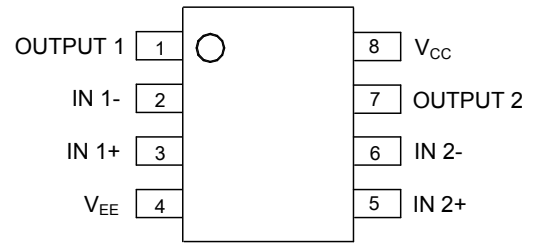

**Applications**

- Active Filters
- Low Power, Low Voltage Applications
- General Purpose Portable Devices
- Cellular Phone, Cordless Phone
- Battery-Powered Systems

**Functional Block Diagram**

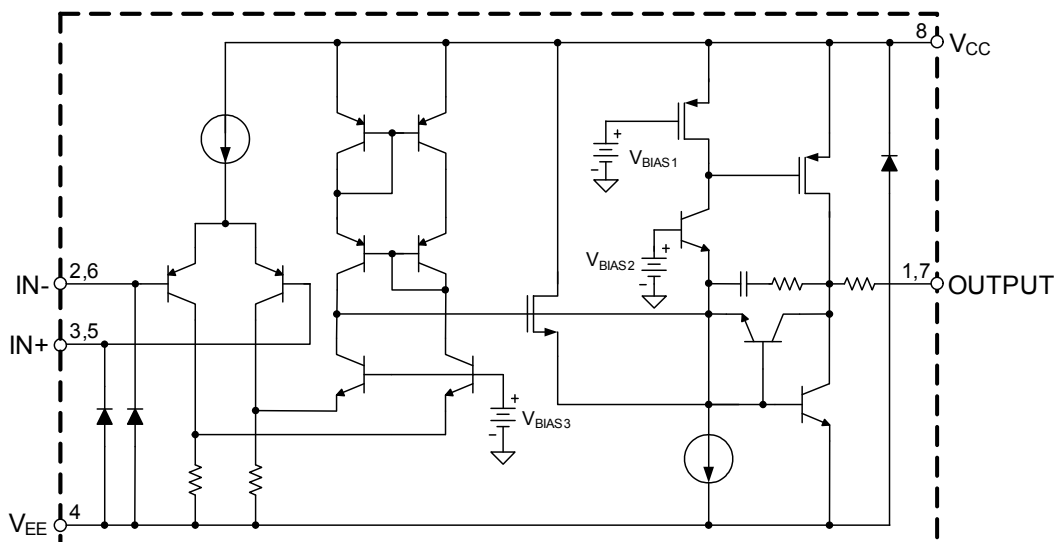

**Absolute Maximum Ratings** (@ $T_A=25^{\circ}\text{C}$ , unless otherwise specified. Note 1)

| Symbol     | Parameter                                | Rating     | Unit               |
|------------|--|------------|--------------------|
| $V_{CC}$   | Power Supply Voltage                     | 6          | V                  |
| $T_J$      | Operation Junction Temperature           | 150        | $^{\circ}\text{C}$ |
| $T_{STG}$  | Storage Temperature Range                | -65 to 150 | $^{\circ}\text{C}$ |
| $T_{LEAD}$ | Lead Temperature (Soldering, 10 seconds) | 260        | $^{\circ}\text{C}$ |
| —          | ESD (Machine Model)                      | 200        | V                  |
| —          | ESD (Human Body Model)                   | 2000       | V                  |

Note 1: Stresses greater than those listed under "Absolute Maximum Ratings" may cause permanent damage to the device. These are stress ratings only, and functional operation of the device at these or any other conditions beyond those indicated under "Recommended Operating Conditions" is not implied. Exposure to "Absolute Maximum Ratings" for extended periods may affect device reliability.

**Recommended Operating Conditions**

| Symbol   | Parameter                           | Min | Max | Unit               |
|----------|-------------------------------------|-----|-----|--------------------|
| $V_{CC}$ | Supply Voltage                      | 2.7 | 5.5 | V                  |
| $T_A$    | Ambient Operating Temperature Range | -40 | 85  | $^{\circ}\text{C}$ |

**2.7V Electrical Characteristics** (@ $T_A=25^{\circ}\text{C}$ , **bold** typeface applies over  $T_A=-40^{\circ}\text{C}$  to  $85^{\circ}\text{C}$ ,  $V_{CC}=2.7\text{V}$ ,  $V_{EE}=0\text{V}$ ,  $V_{CM}=1.0\text{V}$ ,  $V_O=V_{CC}/2$  and  $R_L>1\text{M}\Omega$ , unless otherwise specified. Note 2)

| Symbol       | Parameter                       | Conditions   | Min  | Typ  | Max        | Unit          |
|--------------|---------------------------------|--|------|------|------------|---------------|
| $V_{IO}$     | Input Offset Voltage            | —  | —    | 1.7  | 7          | mV            |
|              |                                 | —  | —    | —    | <b>9</b>   |               |
| $I_B$        | Input Bias Current              | —  | —    | 11   | 250        | nA            |
|              |                                 | —  | —    | —    | <b>500</b> |               |
| $I_{IO}$     | Input Offset Current            | —  | —    | 5    | 50         | nA            |
|              |                                 | —  | —    | —    | <b>150</b> |               |
| $V_{CM}$     | Input Common Mode Voltage Range | for $CMRR \geq 50\text{dB}$                                | -0.1 | —    | 1.9        | V             |
| $I_{CC}$     | Supply Current                  | $V_O=V_{CC}/2$ , $A_{VCL}=1$ , No load                     | —    | 140  | 340        | $\mu\text{A}$ |
|              |                                 |  | —    | —    | <b>420</b> |               |
| CMRR         | Common Mode Rejection Ratio     | $0 \leq V_{CM} \leq 1.7\text{V}$                           | 50   | 63   | —          | dB            |
| PSRR         | Power Supply Rejection Ratio    | $2.7\text{V} \leq V_{CC} \leq 5\text{V}$ , $V_O=1\text{V}$ | 50   | 60   | —          | dB            |
| $I_{SOURCE}$ | Output Short Circuit Current    | $V_O=0\text{V}$  | 5    | 20   | —          | mA            |
| $I_{SINK}$   |                                 | $V_O=2.7\text{V}$  | 10   | 30   | —          | mA            |
| $V_{OH}$     | Output Voltage Swing            | $R_L=10\text{k}\Omega$ to $1.35\text{V}$                   | 2.60 | 2.69 | —          | V             |
| $V_{OL}$     |                                 |  | —    | 60   | 180        | mV            |
| GBWP         | Gain Bandwidth Product          | $C_L=200\text{pF}$   | —    | 1    | —          | MHz           |
| $\phi_M$     | Phase Margin                    | —  | —    | 60   | —          | deg           |
| $G_M$        | Gain Margin                     | —  | —    | 10   | —          | dB            |

Note 2: Limits over the full temperature are guaranteed by design, but not tested in production.

**5V Electrical Characteristics** (@ $T_A=25^\circ\text{C}$ , **bold** typeface applies over  $T_A=-40^\circ\text{C}$  to  $85^\circ\text{C}$ ,  $V_{CC}=5\text{V}$ ,  $V_{EE}=0\text{V}$ ,  $V_{CM}=2.0\text{V}$ ,  $V_O=V_{CC}/2$  and  $R_L>1\text{M}\Omega$ , unless otherwise specified. Note 2)

| Symbol       | Parameter                       | Conditions  | Min        | Typ  | Max        | Unit             |
|--------------|---------------------------------|---|------------|------|------------|------------------|
| $V_{IO}$     | Input Offset Voltage            | —   | —          | 1.7  | 7          | mV               |
|              |                                 | —   | —          | —    | <b>9</b>   |                  |
| $I_B$        | Input Bias Current              | —   | —          | 15   | 250        | nA               |
|              |                                 | —   | —          | —    | <b>500</b> |                  |
| $I_{IO}$     | Input Offset Current            | —   | —          | 5    | 50         | nA               |
|              |                                 | —   | —          | —    | <b>150</b> |                  |
| $V_{CM}$     | Input Common Mode Voltage Range | for $CMRR \geq 50\text{dB}$   | -0.1       | —    | 4.2        | V                |
| $I_{CC}$     | Supply Current                  | $V_O=V_{CC}/2$ , $A_{VCL}=1$ , No load  | —          | 210  | 440        | $\mu\text{A}$    |
|              |                                 |   | —          | —    | <b>615</b> |                  |
| $G_V$        | Large Signal Voltage Gain       | $R_L=2\text{k}\Omega$   | 84         | 100  | —          | dB               |
|              |                                 |   | <b>80</b>  | —    | —          |                  |
| CMRR         | Common Mode Rejection Ratio     | $0 \leq V_{CM} \leq 4\text{V}$  | 50         | 63   | —          | dB               |
| PSRR         | Power Supply Rejection Ratio    | $2.7\text{V} \leq V_{CC} \leq 5\text{V}$ , $V_O=1\text{V}$ , $V_{CM}=1\text{V}$ | 50         | 60   | —          | dB               |
| $I_{SOURCE}$ | Output Short Circuit Current    | $V_O=0\text{V}$   | 5          | 60   | —          | mA               |
| $I_{SINK}$   |                                 | $V_O=5\text{V}$   | 10         | 160  | —          | mA               |
| $V_{OH}$     | Output Voltage Swing            | $R_L=2\text{k}\Omega$ to 2.5V   | 4.7        | 4.96 | —          | V                |
|              |                                 |   | <b>4.6</b> | —    | —          |                  |
|              |                                 | $R_L=10\text{k}\Omega$ to 2.5V  | 4.9        | 4.99 | —          |                  |
|              |                                 |   | <b>4.8</b> | —    | —          |                  |
| $V_{OL}$     | Output Voltage Swing            | $R_L=2\text{k}\Omega$ to 2.5V   | —          | 120  | 300        | mV               |
|              |                                 |   | —          | —    | <b>400</b> |                  |
|              |                                 | $R_L=10\text{k}\Omega$ to 2.5V  | —          | 65   | 180        |                  |
|              |                                 |   | —          | —    | <b>280</b> |                  |
| SR           | Slew Rate                       | —   | —          | 1    | —          | V/ $\mu\text{s}$ |
| GBWP         | Gain Bandwidth Product          | $C_L=200\text{pF}$  | —          | 1    | —          | MHz              |
| $\phi_M$     | Phase Margin                    | —   | —          | 60   | —          | deg              |
| $G_M$        | Gain Margin                     | —   | —          | 10   | —          | dB               |

Note 2: Limits over the full temperature are guaranteed by design, but not tested in production.

**Performance Characteristics**

**Supply Current vs. Supply Voltage**

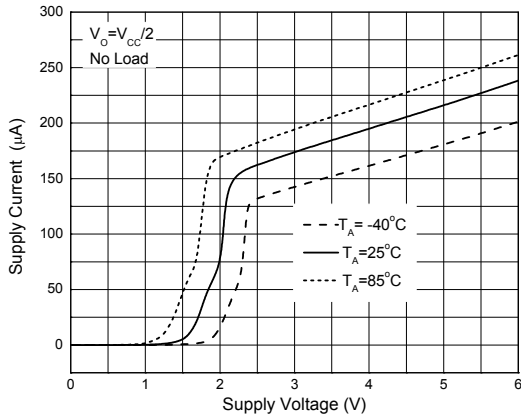

**Supply Current vs. Temperature**

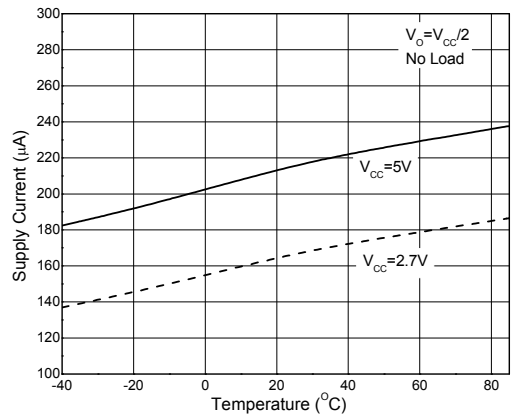

**Slew Rate vs. Supply Voltage**

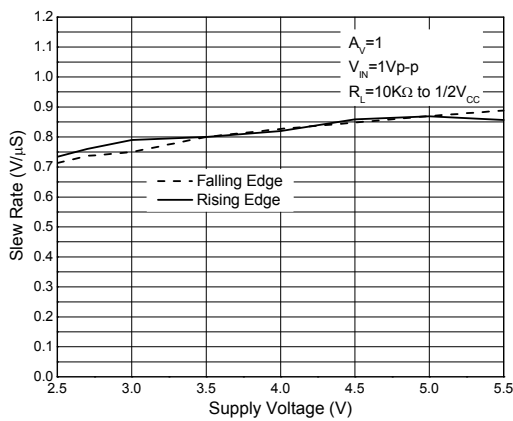

**Output Short Circuit Current vs. Supply Voltage**

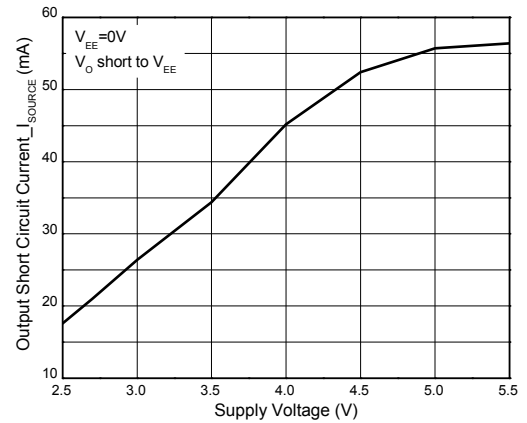

**Output Short Circuit Current vs. Supply Voltage**

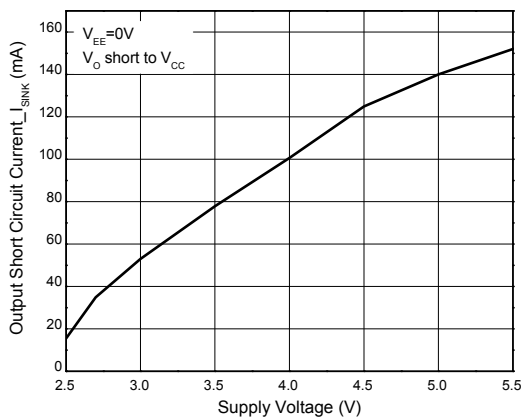

**Output Short Circuit Current vs. Temperature**

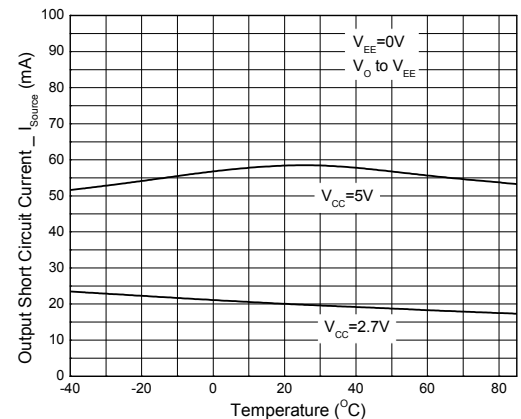

**Performance Characteristics (Cont.)**

**Output Short Circuit Current vs. Temperature**

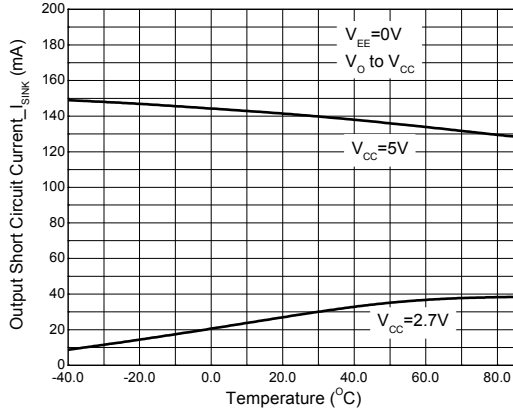

**Output Voltage vs. Output Source Current**

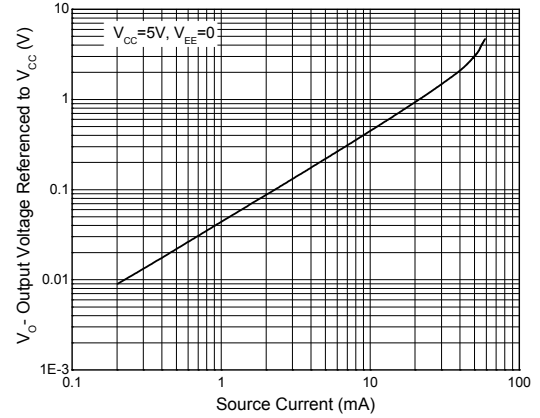

**Output Voltage vs. Output Source Current**

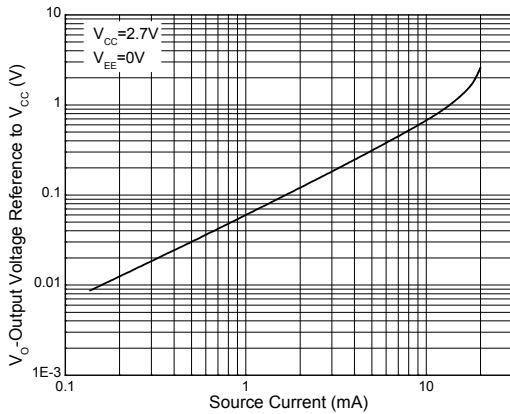

**Output Voltage vs. Output Sink Current**

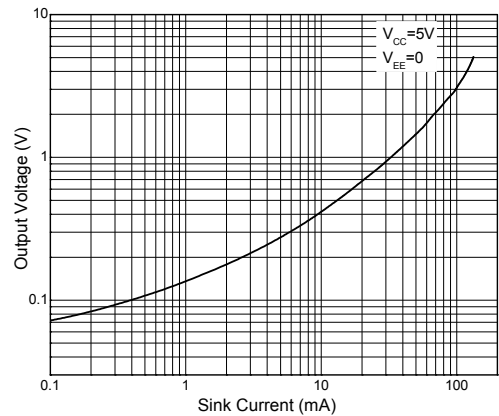

**Output Voltage vs. Output Sink Current**

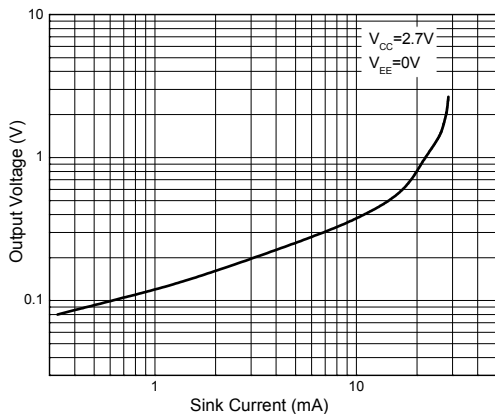

**Output Voltage Swing vs. Supply Voltage**

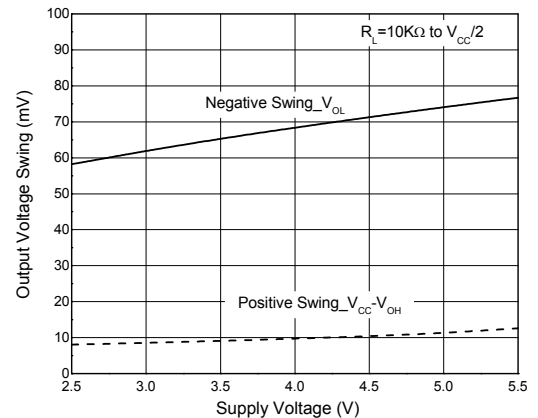

**Performance Characteristics (Cont.)**

**Output Voltage Swing vs. Temperature**

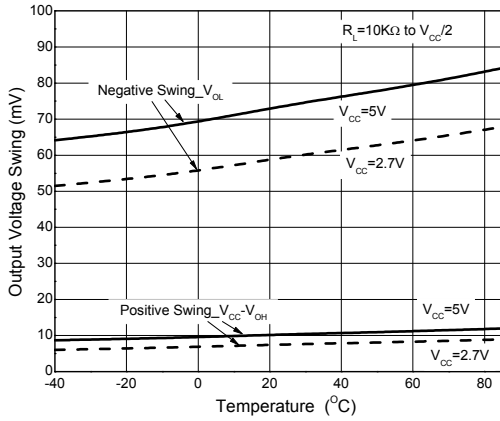

**Gain and Phase vs. Frequency and Resistive Load**

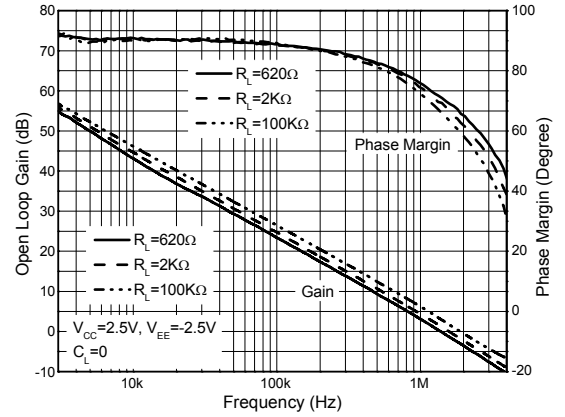

**Gain and Phase vs. Frequency and Capacitive Load**

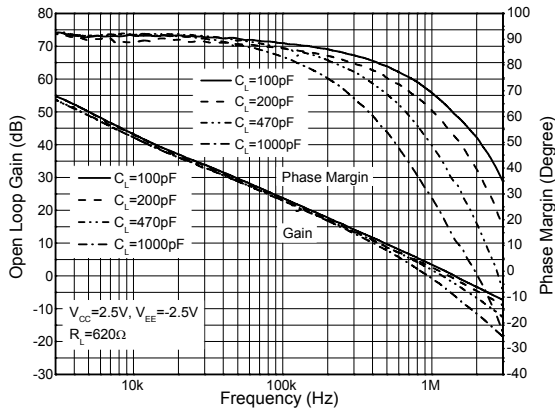

**Gain and Phase vs. Frequency and Capacitive Load**

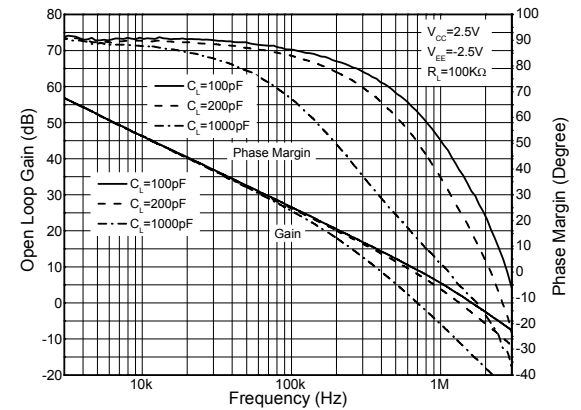

**THD+N vs. Frequency**

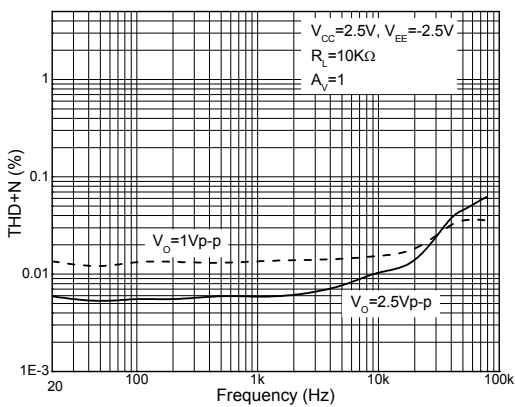

**Non-Inverting Input Small Signal Pulse Response**

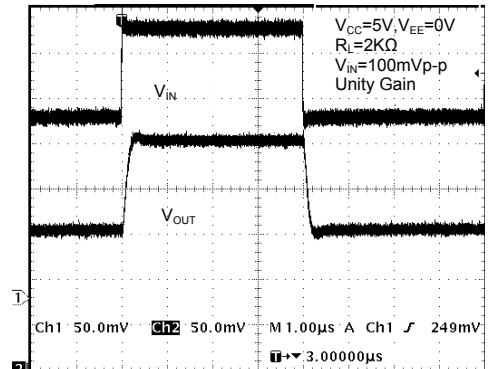

**Performance Characteristics (Cont.)**

**Non-Inverting Input Large Signal Pulse Response**

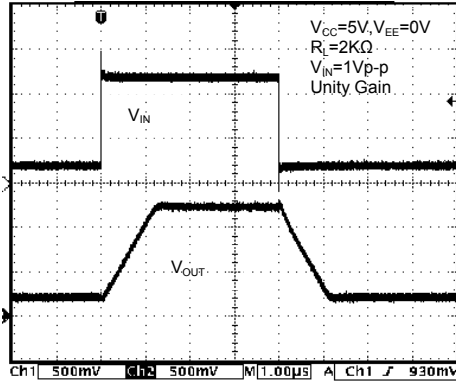

**Non-Inverting Input Small Signal Response**

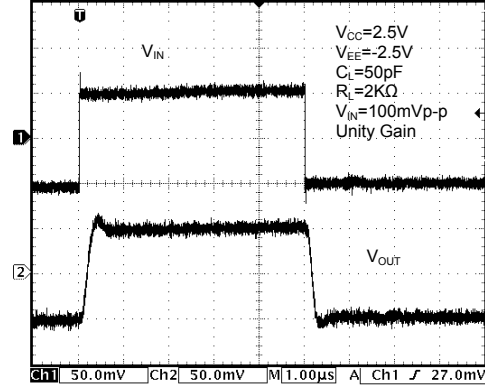

**Non-Inverting Input Small Signal Response**

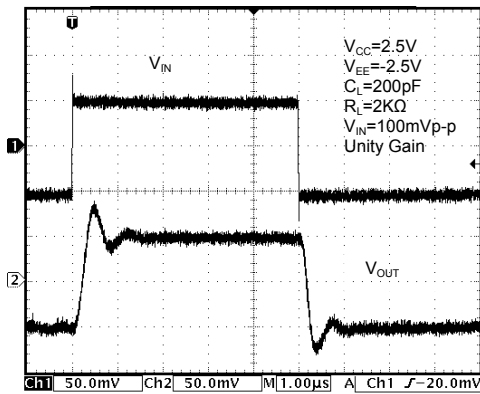

**Ordering Information**

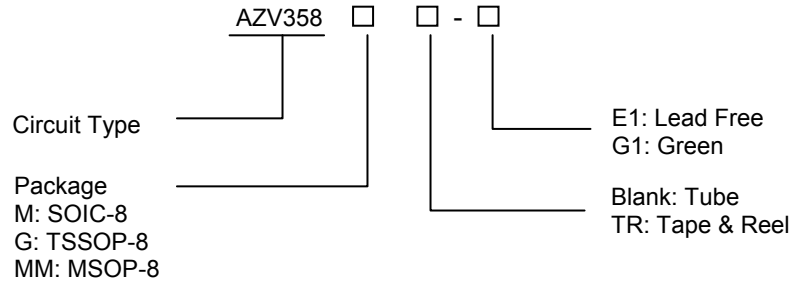

| Package | Temperature Range | Part Number   |               | Marking ID  |             | Packing Type |
|---------|-------------------|---------------|---------------|-------------|-------------|--------------|
|         |                   | Lead Free     | Green         | Lead Free   | Green       |              |
| SOIC-8  | -40 to 85°C       | AZV358M-E1    | AZV358M-G1    | AZV358M-E1  | AZV358M-G1  | Tube         |
|         |                   | AZV358MTR-E1  | AZV358MTR-G1  | AZV358M-E1  | AZV358M-G1  | Tape & Reel  |
| TSSOP-8 | -40 to 85°C       | AZV358G-E1    | AZV358G-G1    | EG3E        | GG3E        | Tube         |
|         |                   | AZV358GTR-E1  | AZV358GTR-G1  | EG3E        | GG3E        | Tape & Reel  |
| MSOP-8  | -40 to 85°C       | AZV358MM-E1   | AZV358MM-G1   | AZV358MM-E1 | AZV358MM-G1 | Tube         |
|         |                   | AZV358MMTR-E1 | AZV358MMTR-G1 | AZV358MM-E1 | AZV358MM-G1 | Tape & Reel  |

BCD Semiconductor's Pb-free products, as designated with "E1" suffix in the part number, are RoHS compliant. Products with "G1" suffix are available in green packages.



**Package Outline Dimensions** (All dimensions in mm(inch).)

**SOIC-8**

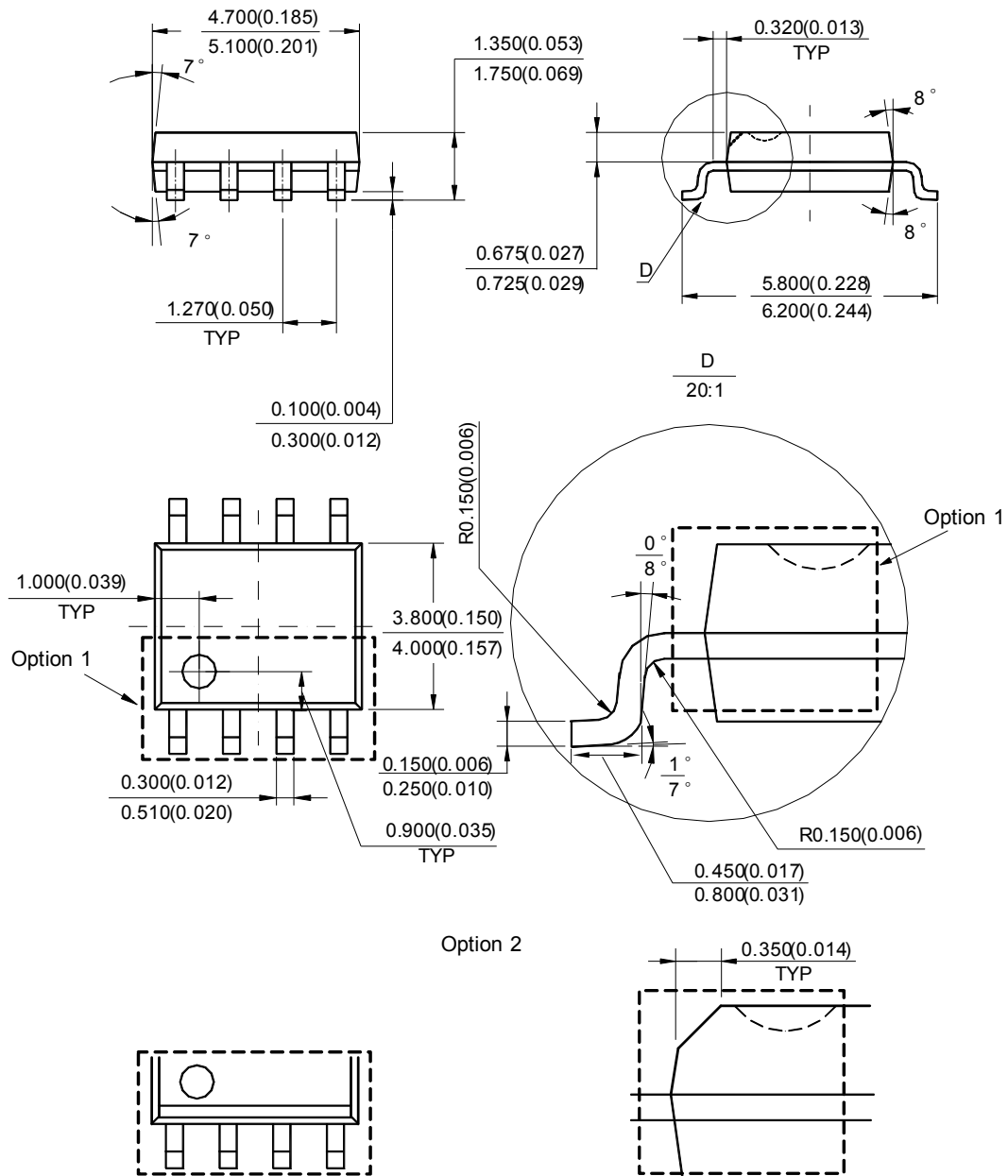

Note: Eject hole, oriented hole and mold mark is optional.

**Package Outline Dimensions** (Cont.) (All dimensions in mm(inch).)

DATA SHEET

**TSSOP-8**

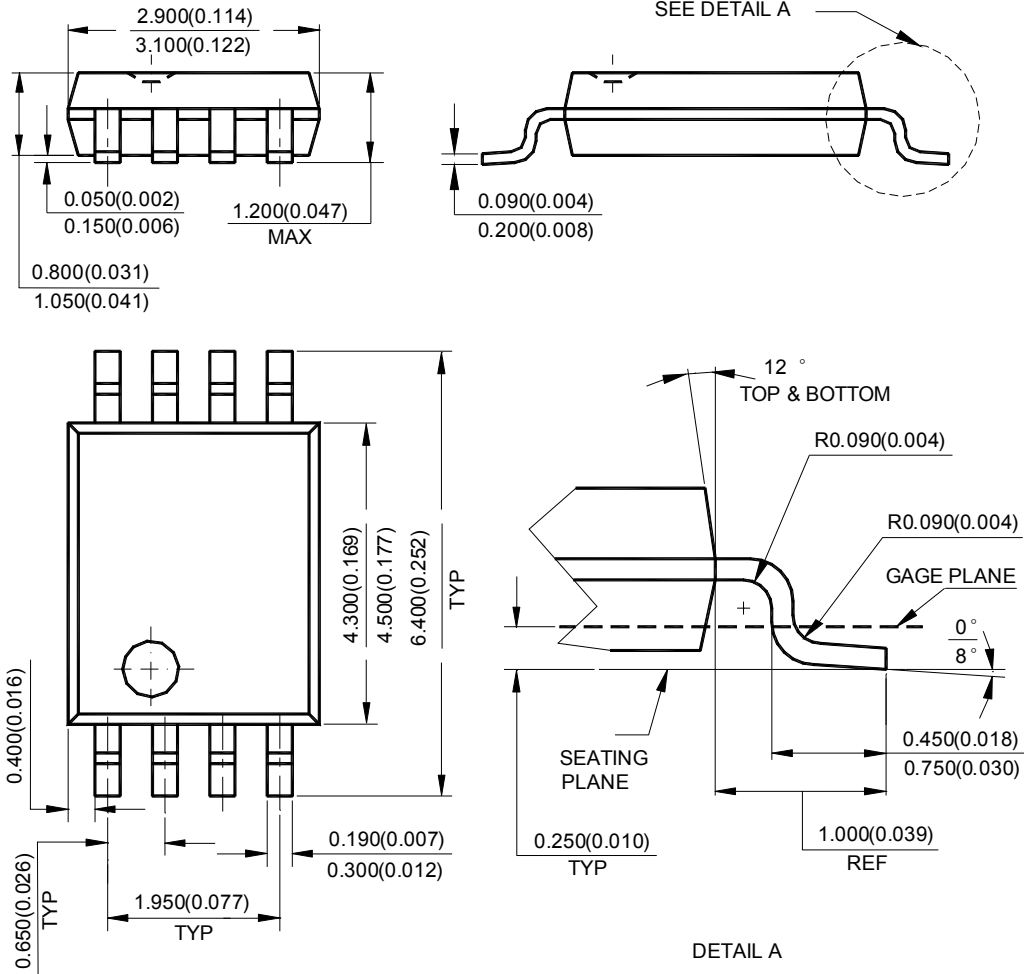

Note: Eject hole, oriented hole and mold mark is optional

**Package Outline Dimensions** (Cont.) (All dimensions in mm(inch).)

**MSOP-8**

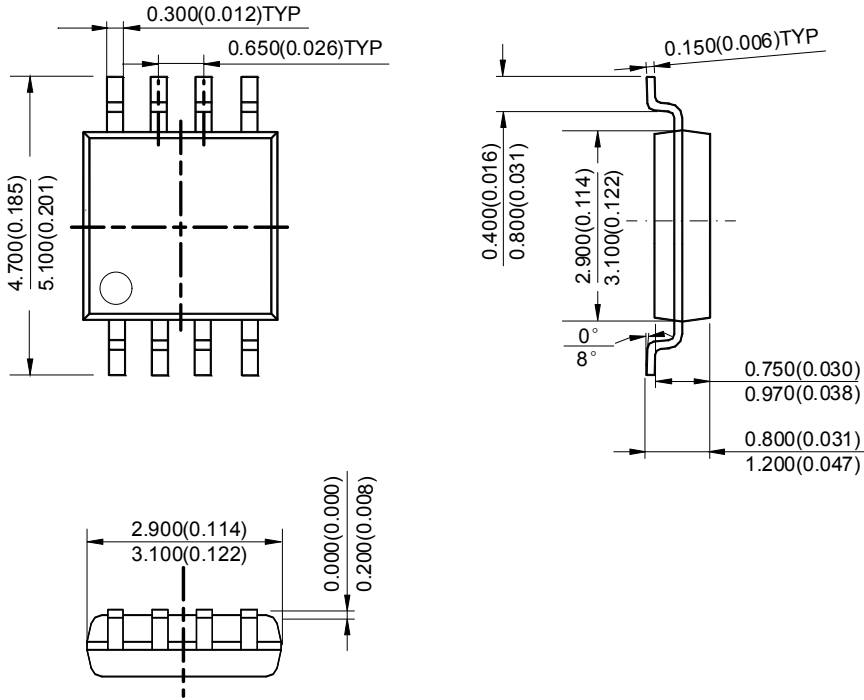

Note: Eject hole, oriented hole and mold mark is optional

**Suggested Pad Layout**

**SOIC-8**

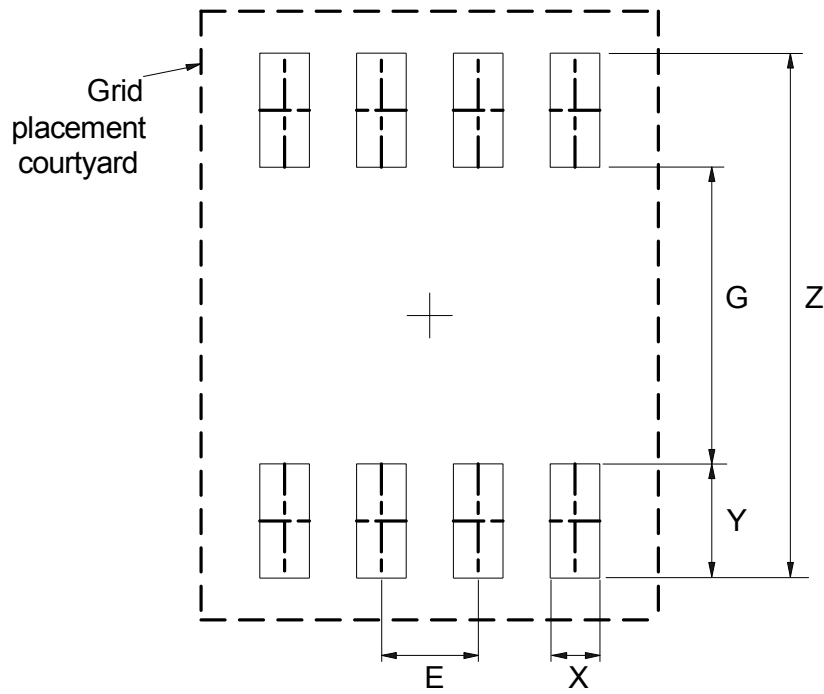

| Dimensions | Z<br>(mm)/(inch) | G<br>(mm)/(inch) | X<br>(mm)/(inch) | Y<br>(mm)/(inch) | E<br>(mm)/(inch) |
|------------|------------------|------------------|------------------|------------------|------------------|
| Value      | 6.900/0.272      | 3.900/0.154      | 0.650/0.026      | 1.500/0.059      | 1.270/0.050      |

**Suggested Pad Layout (Cont.)**

**TSSOP-8**

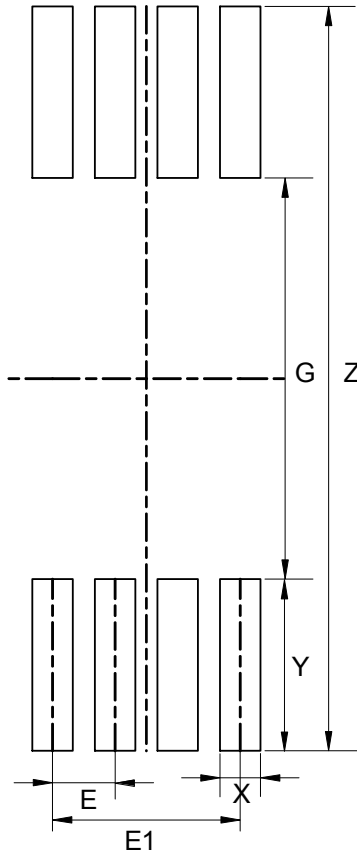

| Dimensions | Z<br>(mm)/(inch) | G<br>(mm)/(inch) | X<br>(mm)/(inch) | Y<br>(mm)/(inch) | E<br>(mm)/(inch) | E1<br>(mm)/(inch) |
|------------|------------------|------------------|------------------|------------------|------------------|-------------------|
| Value      | 7.720/0.304      | 4.160/0.164      | 0.420/0.017      | 1.780/0.070      | 0.650/0.026      | 1.950/0.077       |

**Suggested Pad Layout (Cont.)**

**MSOP-8**

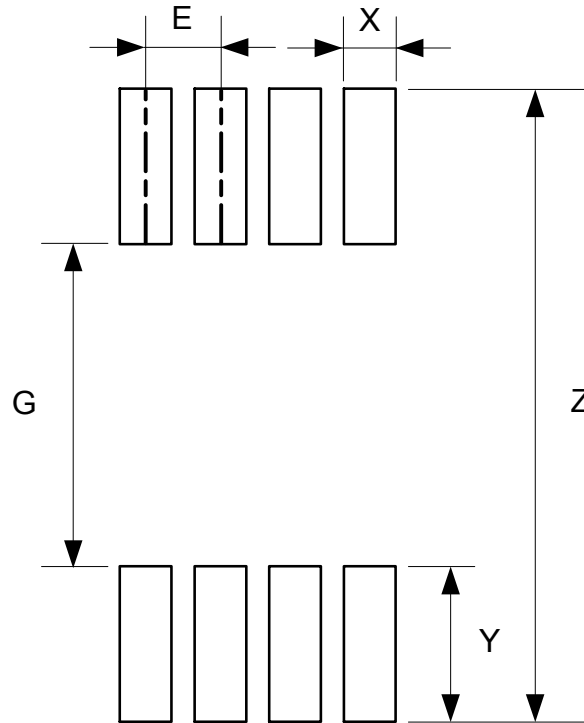

| Dimensions | Z<br>(mm)/(inch) | G<br>(mm)/(inch) | X<br>(mm)/(inch) | Y<br>(mm)/(inch) | E<br>(mm)/(inch) |
|------------|------------------|------------------|------------------|------------------|------------------|
| Value      | 5.500/0.217      | 2.800/0.110      | 0.450/0.018      | 1.350/0.053      | 0.650/0.026      |

**IMPORTANT NOTICE**

DIODES INCORPORATED MAKES NO WARRANTY OF ANY KIND, EXPRESS OR IMPLIED, WITH REGARDS TO THIS DOCUMENT, INCLUDING, BUT NOT LIMITED TO, THE IMPLIED WARRANTIES OF MERCHANTABILITY AND FITNESS FOR A PARTICULAR PURPOSE (AND THEIR EQUIVALENTS UNDER THE LAWS OF ANY JURISDICTION).

Diodes Incorporated and its subsidiaries reserve the right to make modifications, enhancements, improvements, corrections or other changes without further notice to this document and any product described herein. Diodes Incorporated does not assume any liability arising out of the application or use of this document or any product described herein; neither does Diodes Incorporated convey any license under its patent or trademark rights, nor the rights of others. Any Customer or user of this document or products described herein in such applications shall assume all risks of such use and will agree to hold Diodes Incorporated and all the companies whose products are represented on Diodes Incorporated website, harmless against all damages.

Diodes Incorporated does not warrant or accept any liability whatsoever in respect of any products purchased through unauthorized sales channel. Should Customers purchase or use Diodes Incorporated products for any unintended or unauthorized application, Customers shall indemnify and hold Diodes Incorporated and its representatives harmless against all claims, damages, expenses, and attorney fees arising out of, directly or indirectly, any claim of personal injury or death associated with such unintended or unauthorized application.

Products described herein may be covered by one or more United States, international or foreign patents pending. Product names and markings noted herein may also be covered by one or more United States, international or foreign trademarks.

This document is written in English but may be translated into multiple languages for reference. Only the English version of this document is the final and determinative format released by Diodes Incorporated.

**LIFE SUPPORT**

Diodes Incorporated products are specifically not authorized for use as critical components in life support devices or systems without the express written approval of the Chief Executive Officer of Diodes Incorporated. As used herein:

A. Life support devices or systems are devices or systems which:

1. are intended to implant into the body, or
2. support or sustain life and whose failure to perform when properly used in accordance with instructions for use provided in the labeling can be reasonably expected to result in significant injury to the user.

B. A critical component is any component in a life support device or system whose failure to perform can be reasonably expected to cause the failure of the life support device or to affect its safety or effectiveness.

Customers represent that they have all necessary expertise in the safety and regulatory ramifications of their life support devices or systems, and acknowledge and agree that they are solely responsible for all legal, regulatory and safety-related requirements concerning their products and any use of Diodes Incorporated products in such safety-critical, life support devices or systems, notwithstanding any devices- or systems-related information or support that may be provided by Diodes Incorporated. Further, Customers must fully indemnify Diodes Incorporated and its representatives against any damages arising out of the use of Diodes Incorporated products in such safety-critical, life support devices or systems.

Copyright © 2013, Diodes Incorporated

[www.diodes.com](http://www.diodes.com)