

Xinger®

Ultra Low Profile 0805 Balun 75Ω to 75Ω Balanced

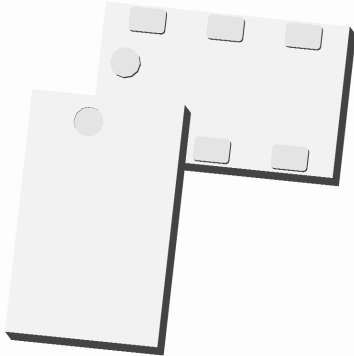

Description

The B0922J7575A50HF is a low cost, low profile sub-miniature unbalanced to balanced transformer designed for differential inputs and output locations on modern chipsets in an easy to use surface mount package covering dual polarized commercial Satellite bands 950 MHz – 1450 MHz & 1650 MHz – 2150 MHz. The B0922J7575A50HF is ideal for high volume manufacturing and delivers higher performance than traditional wire wound baluns. The B0922J7575A50HF has an unbalanced port impedance of 75Ω and a 75Ω balanced port impedance*. This transformation enables single ended signals to be applied to differential ports on modern integrated chipsets. The output ports have equal amplitude (-3dB) with 180 degree phase differential. The B0922J7575A50HF is available on tape and reel for pick and place high volume manufacturing.

Detailed Electrical Specifications: Specifications subject to change without notice.

Features:	Parameter	ROOM (25°C)			Unit
		Min.	Typ.	Max	
<ul style="list-style-type: none"> • 950 – 2150 MHz • 0.6mm Height Profile • 75 Ohm to 2 x 37.5 Ohm • Low Insertion Loss • Sat LNB Chipset Compliant • Input to Output DC Isolation • Surface Mountable • Tape & Reel • Non-conductive Surface • RoHS Compliant • Halogen Free 	Frequency	950		2150	MHz
	Unbalanced Port Impedance		75		Ω
	Balanced Port Impedance		75		Ω
	Return Loss	12	15		dB
	Insertion Loss*		0.8	1.1	dB
	Amplitude Balance		1.0	1.4	dB
	Phase Balance		3	9	Degrees
	CMRR		25		dB
	Power Handling			2	Watts
	Operating Temperature		-55		+85

* Insertion Loss stated at room temperature (Insertion Loss is approximately 0.1 dB higher at +85 °C)

Outline Drawing

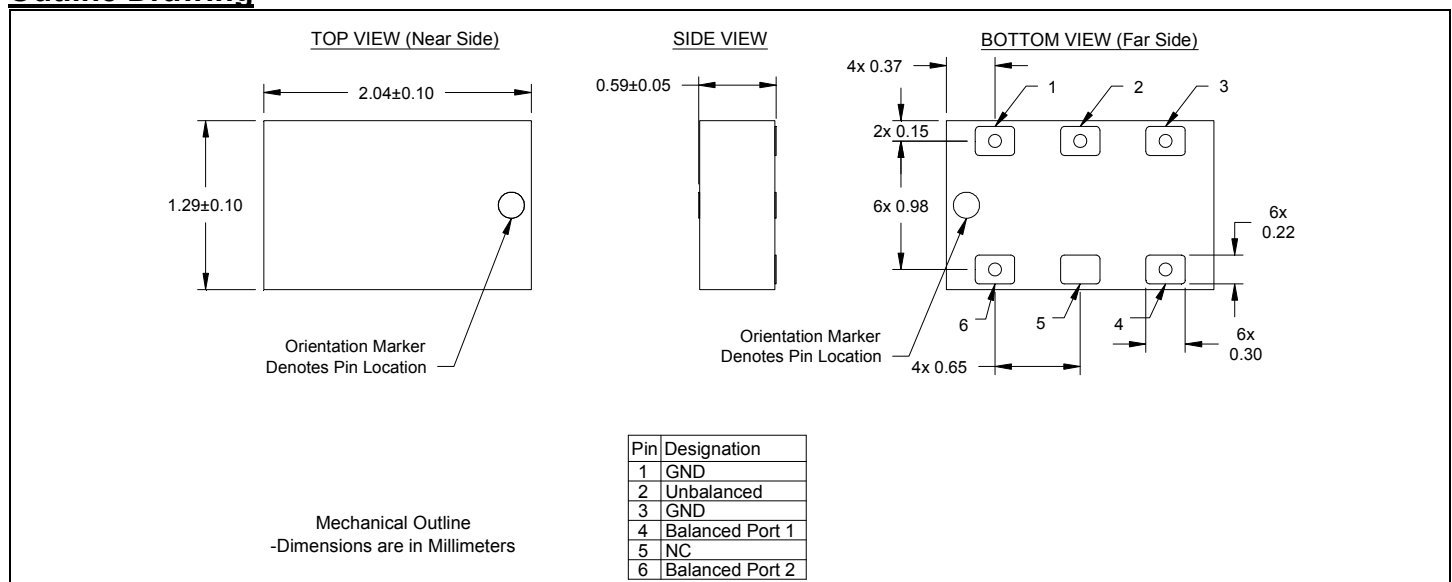

Typical Performance: 600 MHz. to 2600 MHz.

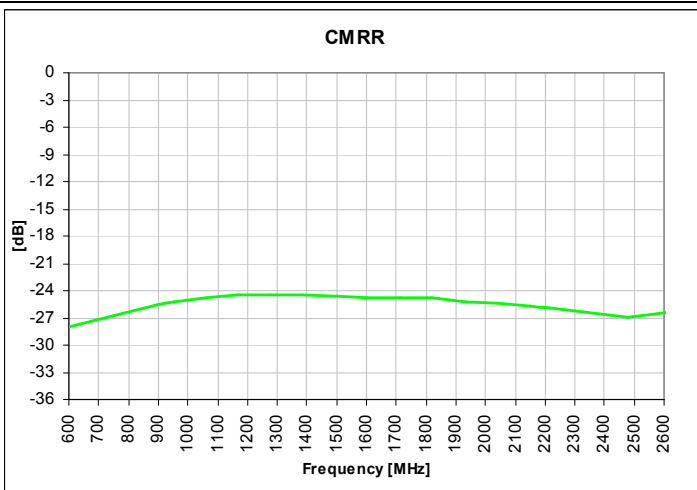
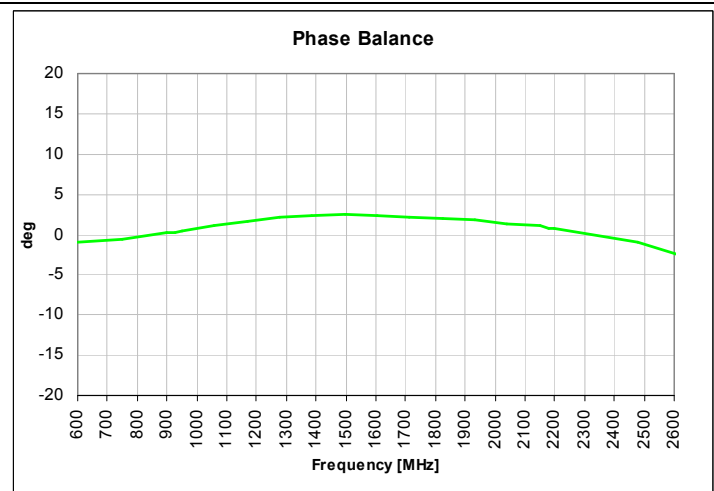
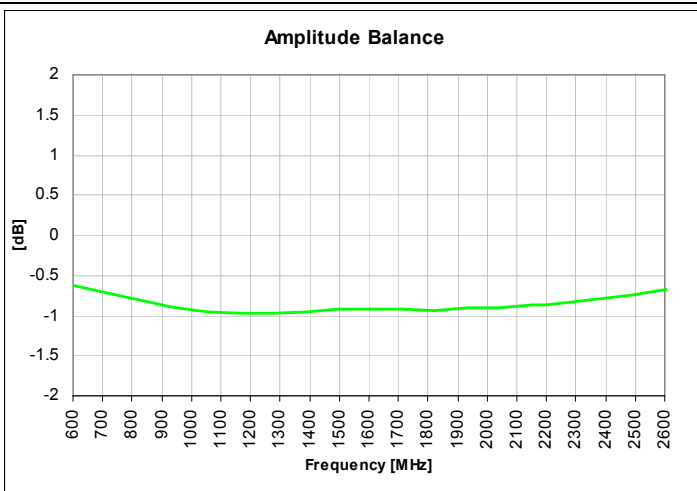
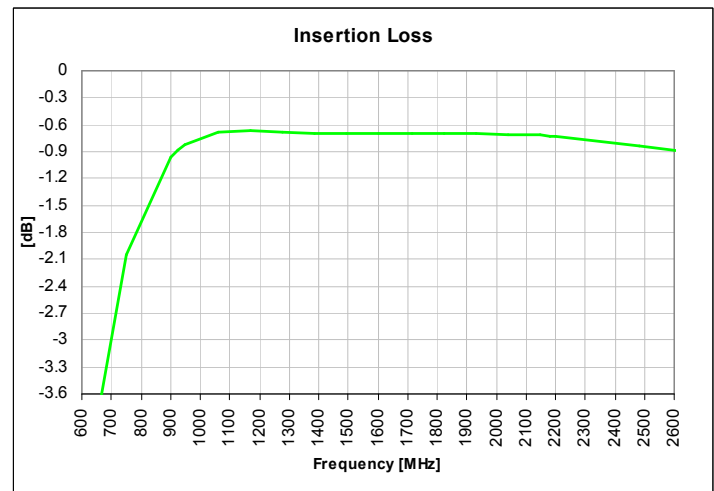
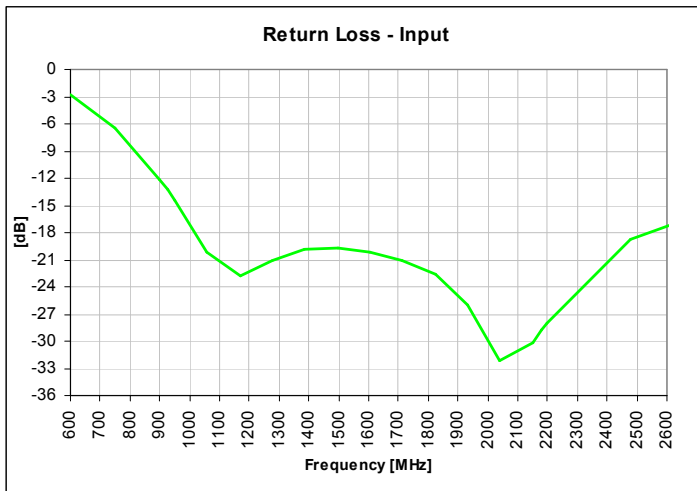

Wide Band Performance: 500 MHz. to 8000 MHz.

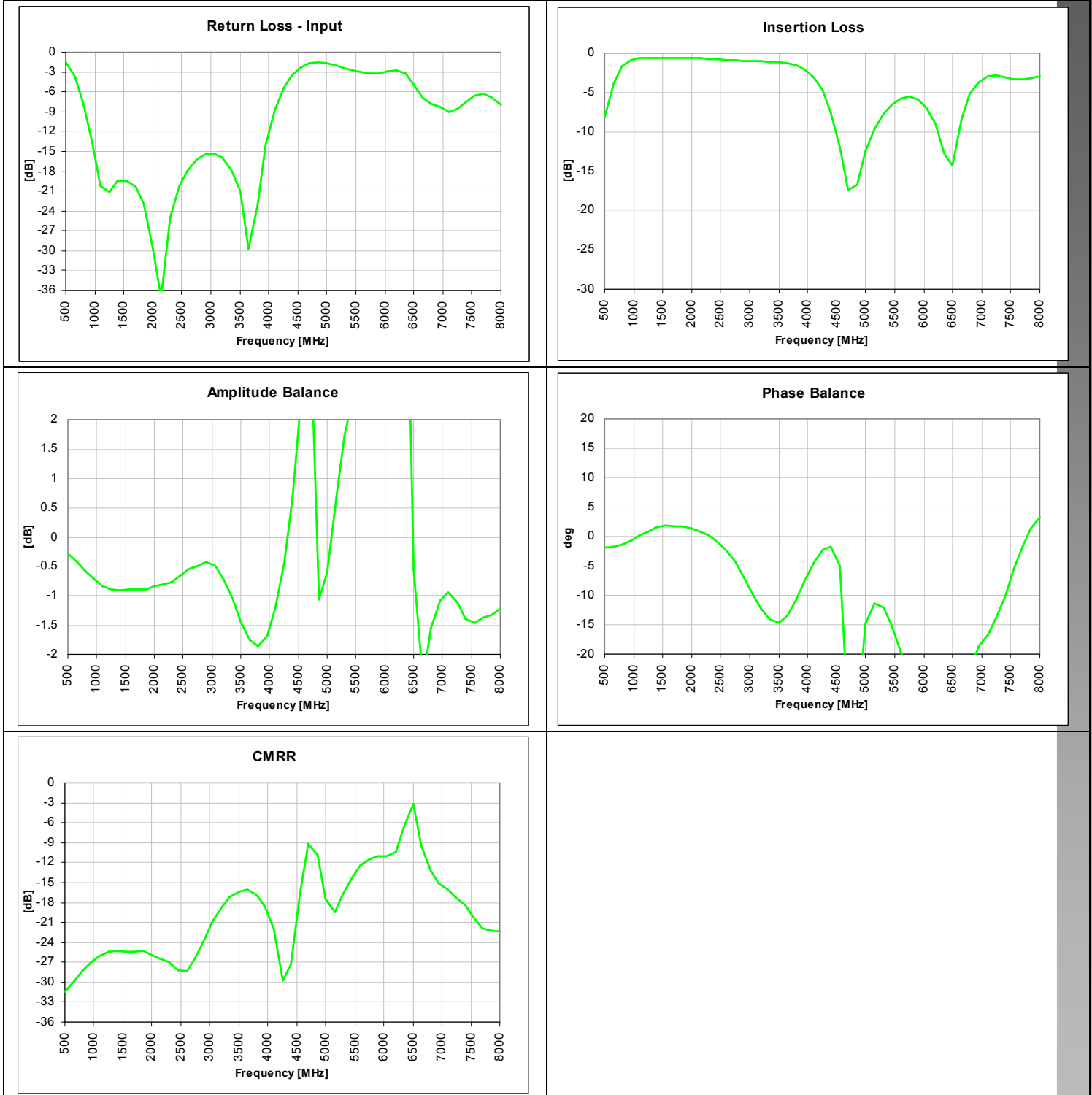

Mounting Configuration:

In order for Xinger surface mount components to work optimally, the proper impedance transmission lines must be used to connect to the RF ports. If this condition is not satisfied, insertion loss, Isolation and VSWR may not meet published specifications.

All of the Xinger components are constructed from organic PTFE based composites which possess excellent electrical and mechanical stability. Xinger components are compliant to a variety of ROHS and Green standards and ready for Pb-free soldering processes. Pads are Gold plated with a Nickel barrier.

An example of the PCB footprint used in the testing of these parts is shown below. In specific designs, the transmission line widths need to be adjusted to the unique dielectric coefficients and thicknesses as well as varying pick and place equipment tolerances.

Mounting Footprint

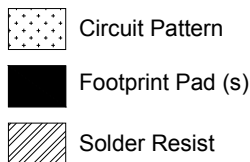
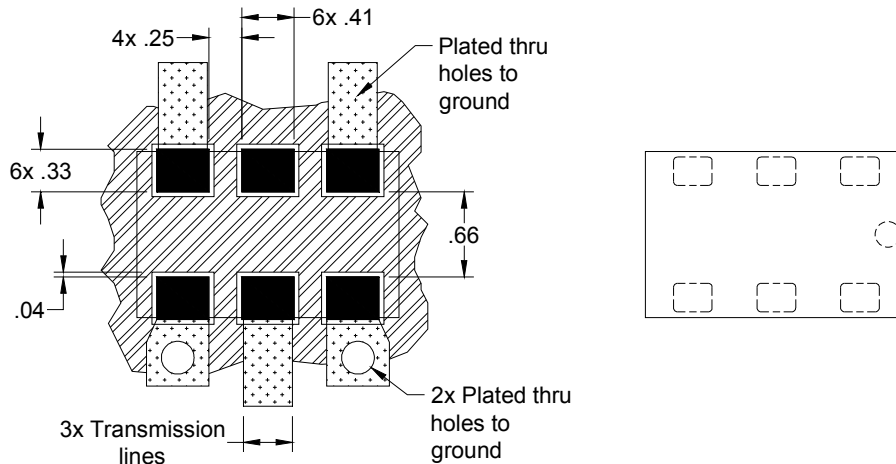

Dimensions are in Millimeters
Mounting Footprint

Packaging and Ordering Information

Parts are available in reel and are packaged per EIA 481-2. Parts are oriented in tape and reel as shown below. Minimum order quantities are 4000 per reel. See Model Numbers below for further ordering information.

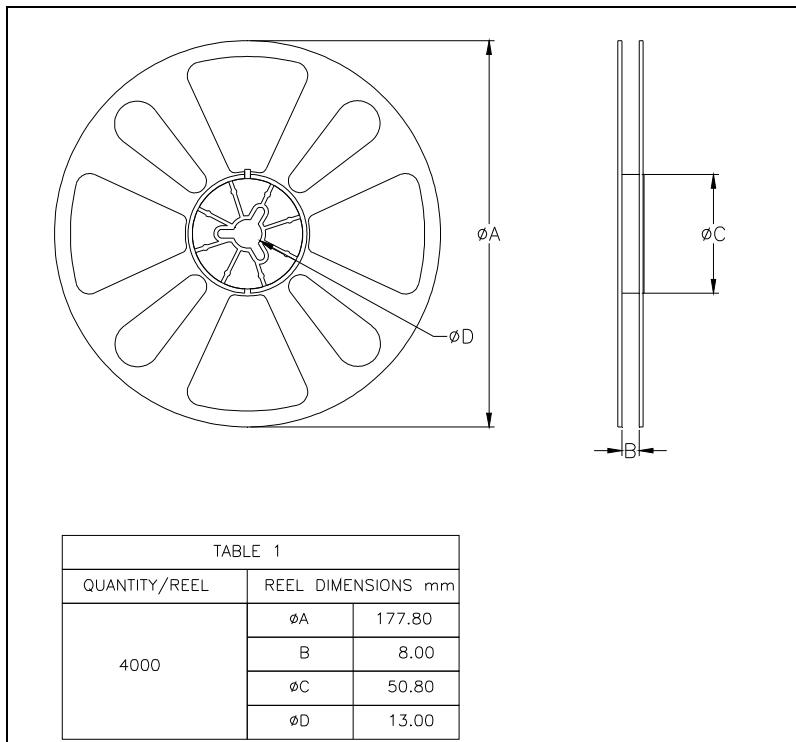
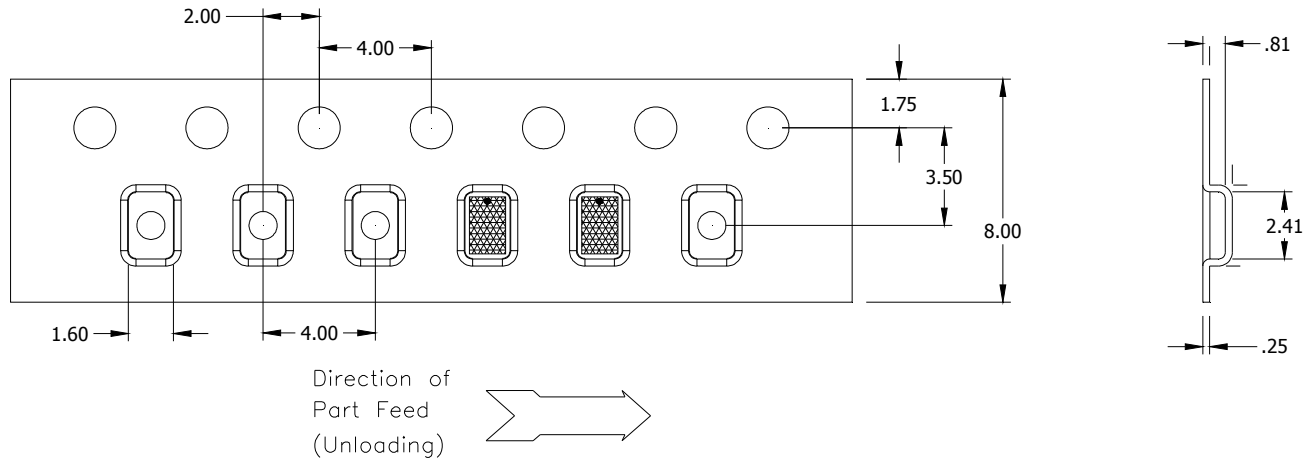

Mouser Electronics

Authorized Distributor

Click to View Pricing, Inventory, Delivery & Lifecycle Information:

[Anaren:](#)

[B0922J7575A50HF](#)