

HF RoHS Battrax® Series Positive/Negative - Modified DO-214



Agency Approvals

Agency	Agency File Number
	E133083

Pinout Designation

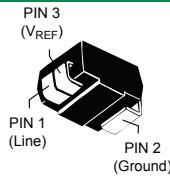

Schematic Symbol

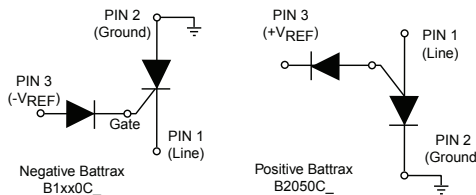

Description

The Battrax® series offers programmable SIDACtor® overvoltage protection devices for SLIC applications. This series is offered in a negative Battrax version and a positive Battrax version. The B1xx0C_ is for a $-V_{REF}$ supply and the B2050C_ is for a $+V_{REF}$ supply. Designed using an SCR and a gate diode, the B1xx0C_ Battrax begins to conduct at $|-V_{REF}| + |-1.2V|$ while the B2050C_ Battrax begins to conduct at $|+V_{REF}| + |1.2V|$.

Features and Benefits

- Low voltage overshoot ratings
- Low on-state voltage
- Does not degrade with use
- Fails short circuit when surged in excess of ratings
- Robust surge current ratings
- Gate triggered tracking devices

Applicable Global Standards

- TIA-968-A
- TIA-968-B
- ITU K.20/21 Enhanced Level*
- ITU K.20/21 Basic Level
- GR 1089 Intra-building
- IEC 61000-4-5
- YD/T 1082
- YD/T 993
- YD/T 950

*A-rated parts require series resistance

Electrical Characteristics

Part Number	Marking	V_{DRM} @ $I_{DRM} = 5\mu A$	V_S @ $100V/\mu s$	I_H	I_S	I_T	V_T @ $I_T = 2.2$ Amps	Capacitance*	
		V min	V max	mA min	mA max	A max	V max	pF	
								Min	Max
B1100CALRP	B10A	$-V_{REF} + -1.2V $	$-V_{REF} + -10V $	100	100	2.2	4	30	200
B1160CALRP	B16A	$-V_{REF} + -1.2V $	$-V_{REF} + -10V $	160	100	2.2	4	30	200
B1200CALRP	B12A	$-V_{REF} + -1.2V $	$-V_{REF} + -10V $	200	100	2.2	4	30	200
B2050CALRP	B25A	$+V_{REF} + 1.2V $	$+V_{REF} + 10V $	5	50	2.2	4	20	200
B1100CCLRP	B10C	$-V_{REF} + -1.2V $	$-V_{REF} + -10V $	100	100	2.2	4	30	200
B1160CCLRP	B16C	$-V_{REF} + -1.2V $	$-V_{REF} + -10V $	160	100	2.2	4	30	200
B1200CCLRP	B12C	$-V_{REF} + -1.2V $	$-V_{REF} + -10V $	200	100	2.2	4	30	200
B2050CCLRP	B25C	$+V_{REF} + 1.2V $	$+V_{REF} + 10V $	5	50	2.2	4	20	200

Notes:
 - Absolute maximum ratings measured at $T_A = 25^\circ C$ (unless otherwise noted).
 - Devices are uni-directional
 - All electrical characteristics shown are defined from Tip (pin 1) to Ground (pin 2), and Ring (pin 1) to Ground (pin 2)

- V_{REF} Max Value for the negative Battrax is -200 V.
 - V_{REF} Max Value for the positive Battrax is 110 V.
 * Off-state capacitance (C_o) is measured across pins 1 & 2 at 1 MHz with a 2V bias.

Surge Ratings

Series	I_{PP}									I_{TSM} 50/60 Hz	di/dt
	0.2x310 ¹ 0.5x700 ²	2x10 ¹ 2x10 ²	8x20 ¹ 1.2x50 ²	10x160 ¹ 10x160 ²	10x560 ¹ 10x560 ²	5x320 ¹ 9x720 ²	10x360 ¹ 10x360 ²	10x1000 ¹ 10x1000 ²	5x310 ¹ 10x700 ²		
	A min	A min	A min	A min	A min	A min	A min	A min	A min		
A	20	150	150	90	50	75	75	45	75	20	500
C	50	500	400	200	150	200	175	100	200	50	500

Notes:

- 1 Current waveform in μs
- 2 Voltage waveform in μs
- Peak pulse current rating (I_{PP}) is repetitive and guaranteed for the life of the product.
- I_{PP} ratings applicable over temperature range of $-40^{\circ}C$ to $+85^{\circ}C$ (I_{PP} rating assumes V_{REF} equals $\pm 48V$)
- The device must initially be in thermal equilibrium with $-40^{\circ}C \leq T_J \leq +150^{\circ}C$

Thermal Considerations

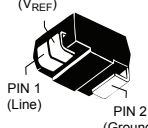
Package	Symbol	Parameter	Value	Unit
Modified DO-214AA PIN 3 (V_{REF}) 	T_J	Operating Junction Temperature Range	-40 to +150	$^{\circ}C$
	T_S	Storage Temperature Range	-65 to +150	$^{\circ}C$
	$R_{\theta JA}$	Thermal Resistance: Junction to Ambient	85	$^{\circ}C/W$

V-I Characteristics - Negative BattraX

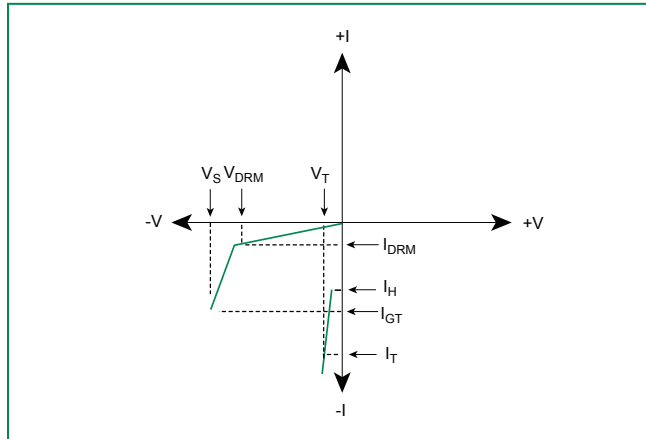

V-I Characteristics - Positive BattraX

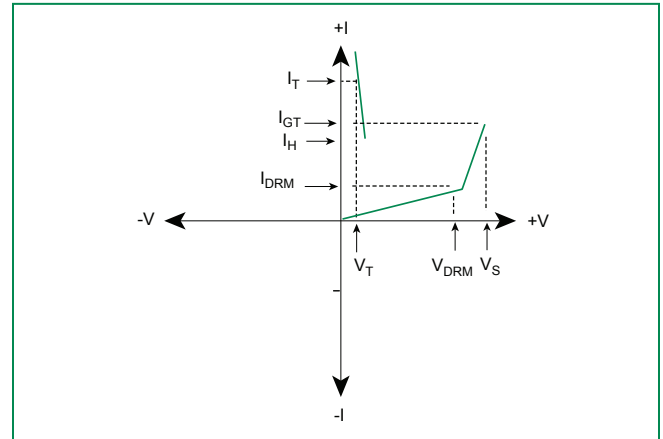

Normalized V_S Change vs. Junction Temperature

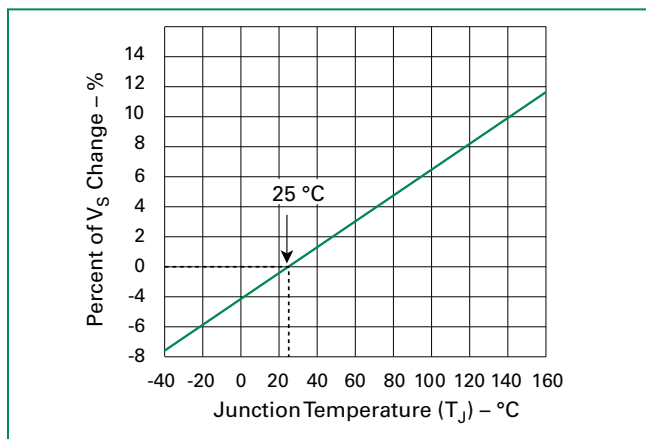

Normalized DC Holding Current vs. Case Temperature

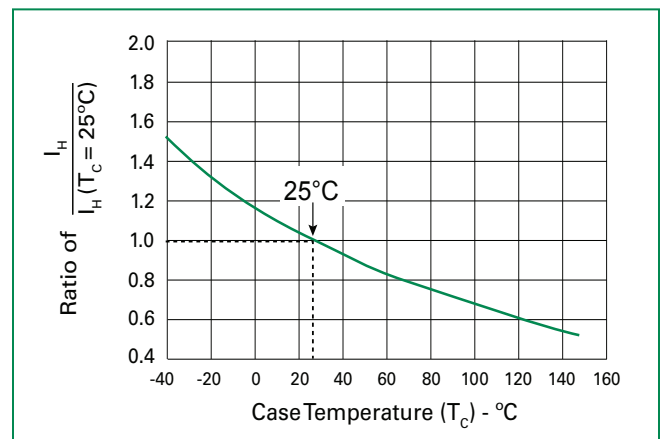

$t_r \times t_d$ Pulse Waveform

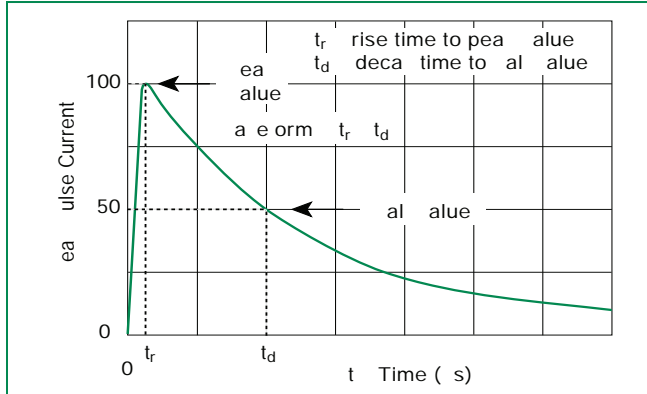

Physical Specifications

Lead Material	Copper Alloy
Terminal Finish	100% Matte-Tin Plated
Body Material	UL recognized epoxy meeting flammability classification 94V-0

Environmental Specifications

High Temp Voltage Blocking	80% Rated V_{REF} Max. (V_{DC} Peak) +125°C or +150°C, 504 or 1008 hrs. MIL-STD-750 (Method 1040) JEDEC, JESD22-A-101
Temp Cycling	-65°C to +150°C, 15 min. dwell, 10 up to 100 cycles. MIL-STD-750 (Method 1051) EIA/JEDEC, JESD22-A104
Biased Temp & Humidity	52 V_{DC} (+85°C) 85%RH, 504 up to 1008 hrs. EIA/JEDEC, JESD22-A-101
High Temp Storage	+150°C 1008 hrs. MIL-STD-750 (Method 1031) JEDEC, JESD22-A-101
Low Temp Storage	-65°C, 1008 hrs.
Thermal Shock	0°C to +100°C, 5 min. dwell, 10 sec. transfer, 10 cycles. MIL-STD-750 (Method 1056) JEDEC, JESD22-A-106
Autoclave (Pressure Cooker Test)	+121°C, 100%RH, 2atm, 24 up to 168 hrs. EIA/JEDEC, JESD22-A-102
Resistance to Solder Heat	+260°C, 30 secs. MIL-STD-750 (Method 2031)
Moisture Sensitivity Level	85%RH, +85°C, 168 hrs., 3 reflow cycles (+260°C Peak). JEDEC-J-STD-020, Level 1

Soldering Parameters

Reflow Condition	Pb-Free assembly (see Fig. 1)	
Pre Heat	-Temperature Min ($T_{s(min)}$)	+150°C
	-Temperature Max ($T_{s(max)}$)	+200°C
	-Time (Min to Max) (t_s)	60-180 secs.
Average ramp up rate (Liquidus Temp (T_L) to peak)	3°C/sec. Max.	
$T_{s(max)}$ to T_L - Ramp-up Rate	3°C/sec. Max.	
Reflow	-Temperature (T_L) (Liquidus)	+217°C
	-Temperature (t_L)	60-150 secs.
Peak Temp (T_p)	+260(+0/-5)°C	
Time within 5°C of actual PeakTemp (t_p)	30 secs. Max.	
Ramp-down Rate	6°C/sec. Max.	
Time 25°C to Peak Temp (T_p)	8 min. Max.	
Do not exceed	+260°C	

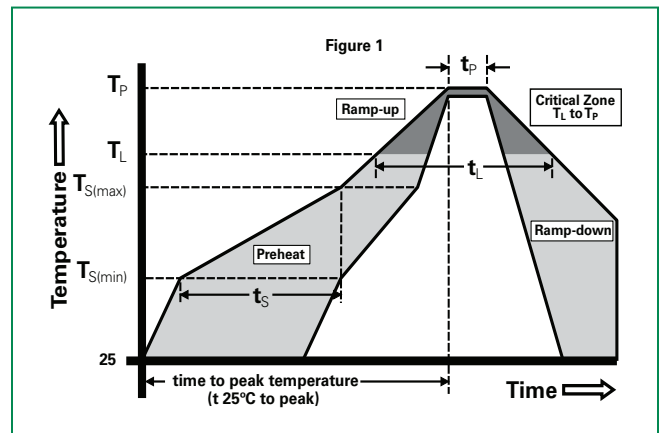

Part Numbering

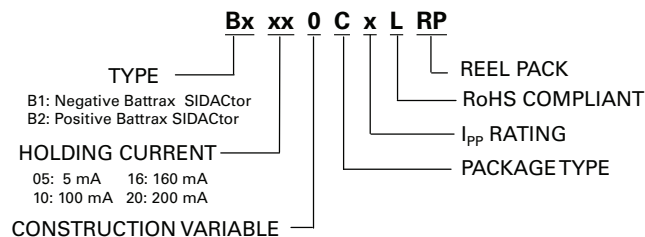

Part Marking

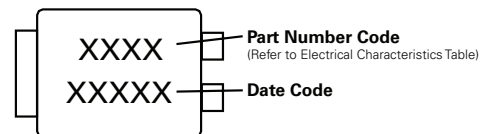

Dimensions — Modified DO-214AA

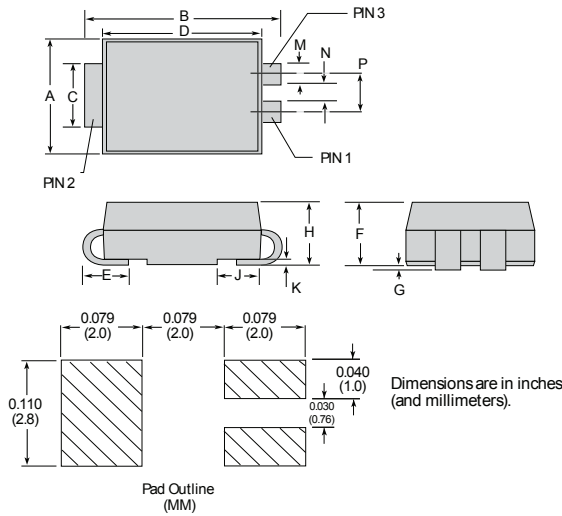

Dimensions	Inches		Millimeters	
	Min	Max	Min	Max
A	0.130	0.156	3.30	3.95
B	0.201	0.220	5.10	5.60
C	0.077	0.087	1.95	2.20
D	0.159	0.181	4.05	4.60
E	0.030	0.063	0.75	1.60
F	0.075	0.096	1.90	2.45
G	0.002	0.008	0.05	0.20
H	0.077	0.104	1.95	2.65
K	0.006	0.016	0.15	0.41
M	0.022	0.028	0.56	0.71
N	0.027	0.033	0.69	0.84
P	0.052	0.058	1.32	1.47

Packing Options

Package Type	Description	Quantity	Added Suffix	Industry Standard
C	Modified DO-214AA 3-leaded Tape and Reel Pack	2500	RP	EIA-481-D

Tape and Reel Specification — Modified DO-214AA

