

Darlington

2SB1382

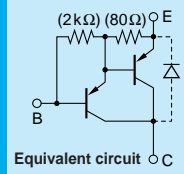

Silicon PNP Epitaxial Planar Transistor (Complement to type 2SD2082)

Application : Chopper Regulator, DC Motor Driver and General Purpose

Absolute maximum ratings (Ta=25°C)

Symbol	2SB1382	Unit
V _{CB0}	-120	V
V _{CEO}	-120	V
V _{EB0}	-6	V
I _C	-16(Pulse-26)	A
I _B	-1	A
P _C	75(T _C =25°C)	W
T _J	150	°C
T _{stg}	-55 to +150	°C

Electrical Characteristics (Ta=25°C)

Symbol	Conditions	2SB1382	Unit
I _{CB0}	V _{CB} =-120V	-10max	μA
I _{EB0}	V _{EB} =-6V	-10max	mA
V _{(BR)CEO}	I _C =-10mA	-120min	V
h _{FE}	V _{CE} =-4V, I _C =-8A	2000min	
V _{CE(sat)}	I _C =-8A, I _B =-16mA	-1.5max	V
V _{BE(sat)}	I _C =-8A, I _B =-16mA	-2.5max	V
f _T	V _{CE} =-12V, I _E =1A	50typ	MHz
COB	V _{CB} =-10V, f=1MHz	350typ	pF

External Dimensions FM100(TO3PF)

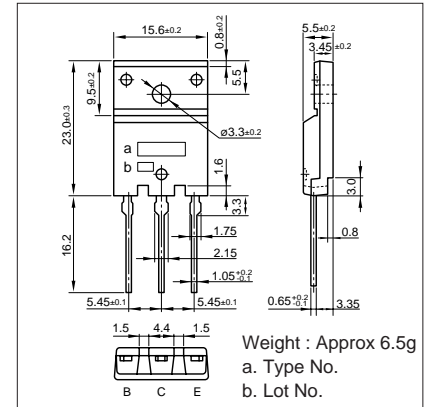

Typical Switching Characteristics (Common Emitter)

V _{CC} (V)	R _L (Ω)	I _C (A)	V _{BB1} (V)	V _{BB2} (V)	I _{B1} (mA)	I _{B2} (mA)	t _{on} (μs)	t _{stg} (μs)	t _f (μs)
-40	5	-8	-10	5	-16	16	0.8typ	1.8typ	1.0typ

I_C-V_{CE} Characteristics (Typical)

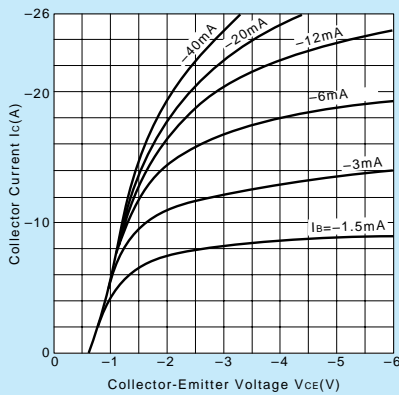

V_{CE(sat)}-I_B Characteristics (Typical)

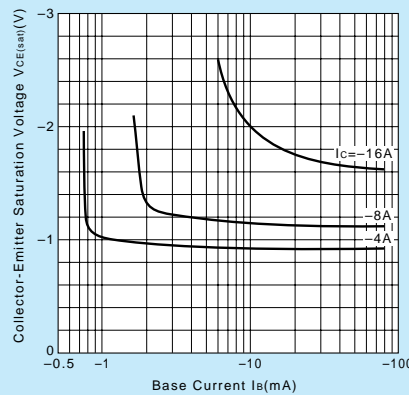

I_C-V_{BE} Temperature Characteristics (Typical)

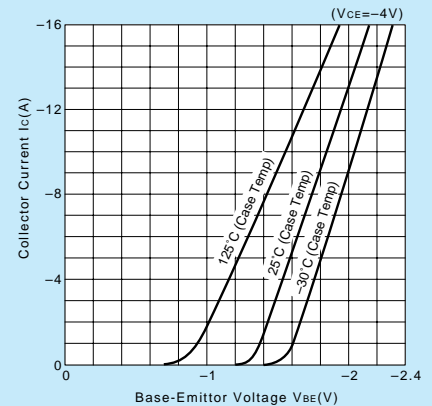

h_{FE}-I_C Characteristics (Typical)

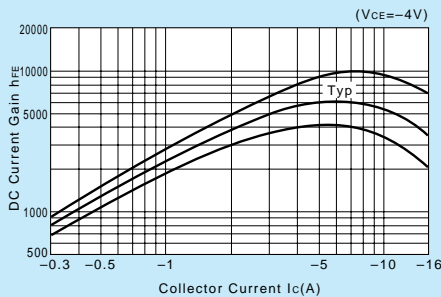

h_{FE}-I_C Temperature Characteristics (Typical)

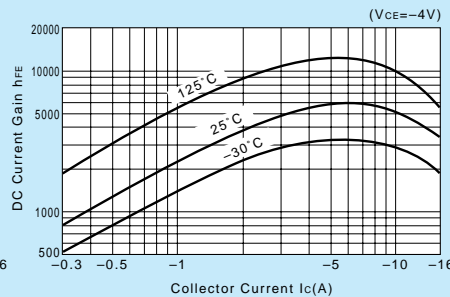

θ_{j-a}-t Characteristics

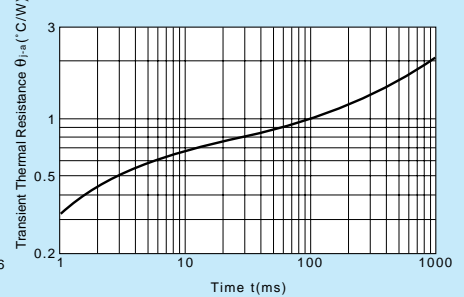

f_T-I_E Characteristics (Typical)

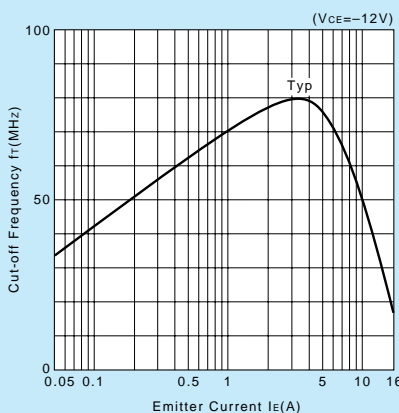

Safe Operating Area (Single Pulse)

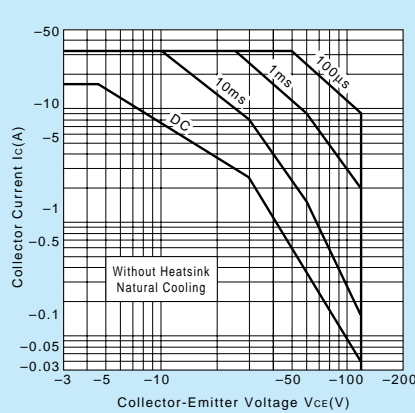

P_C-T_a Derating

