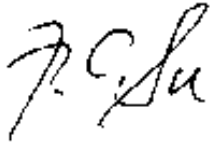
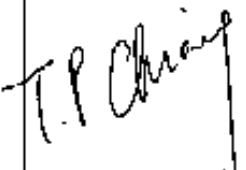

Spec. No.	413-212-067
Version :	4
Total pages :	16
Date :	2001.12.18

## 141.1" COLOR TFT-LCD MODULE SPECIFICATION

**MODEL NAME: B141XN03 (UB141X01)**

The content of this technical information is subject to change without notice.  
Please contact AU or its agent for further information.

Approved by	Checked by	Prepared by
		Frank Hsu



**Contents:**

**A. Physical specification..... P2**

**B. Electrical specifications..... P3**

    1. Pin assignment..... **P3**

    2. Absolute maximum ratings..... **P4**

    3. Electrical characteristics..... **P5**

        a. Typical operating conditions..... **P5**

        b. Display color v.s. input data signals..... **P6**

        c. Input signal timing..... **P7**

        d. Display position..... **P8**

        e. Backlight driving conditions..... **P9**

**C. Optical specifications..... P10**

**D. Reliability test items..... P12**

**E. Display quality..... P12**

**F. Handling precaution ..... P12**

**G. Packing form..... P13**

**Appendix:**

    Fig.1-(a) LCM outline dimensions(Front side)..... **P14**

    Fig.1-(b) LCM outline dimensions (Back side)..... **P15**

    Fig.2 Timing chart..... **P16**

**A. Physical specifications**

NO.	Item	Specification	Remark
1	Display resolution(pixel)	1024(H) × 768(V)	
2	Active area(mm)	285.7(H) × 214.3(V)	
3	Screen size(inch)	14.1(Diagonal)	
4	Pixel pitch(mm)	0.279(H) × 0.279(V)	
5	Color configuration	R. G. B. Vertical stripe	
6	Overall dimension(mm)	298.5(W) × 226.7(H) × 6.1 max(D)	Note 1
7	Weight(g)	550 ± 10	
8	Surface treatment	Hard coating(3H), anti-glare of the front polarizer(12%)	

Note 1: Refer to Fig. 1.

**B. Electrical specifications**

1.Pin assignment

(1).Input signal interface

CN1 (20P) connector : FI-SEB-20P-HF10(JAE)

Pin no	Symbol	Function	Etc.
1	V <sub>CC</sub>	+3.3 V power supply	
2	V <sub>CC</sub>	+3.3 V power supply	
3	GND	Ground	
4	GND	Ground	
5	RxIN0-	LVDS receiver signal channel 0	
6	RxIN0+		
7	GND	Ground	
8	RxIN1-	LVDS receiver signal channel 1	
9	RxIN1+		
10	GND	Ground	
11	RxIN2-	LVDS receiver signal channel 2	
12	RxIN2+		
13	GND	Ground	
14	CKIN-	LVDS receiver signal clock	
15	CKIN+		
16	GND	Ground	
17	NC	No Connection	
18	NC	No Connection	
19	GND	Ground	
20	GND	Ground	

(2) LVDS transmitter/receiver signal mapping

	Symbol	Function	
TxIN0	R0	Red data (LSB)	6 bit red display data
TxIN1	R1	Red data	
TxIN2	R2	Red data	
TxIN3	R3	Red data	
TxIN4	R4	Red data	
TxIN5	R5	Red data (MSB)	
TxIN6	G0	Green data (LSB)	6 bit green display data
TxIN7	G1	Green data	
TxIN8	G2	Green data	
TxIN9	G3	Green data	
TxIN10	G4	Green data	
TxIN11	G5	Green data (MSB)	
TxIN12	B0	Blue data (LSB)	6 bits blue display data
TxIN13	B1	Blue data	
TxIN14	B2	Blue data	
TxIN15	B3	Blue data	
TxIN16	B4	Blue data	
TxIN17	B5	Blue data (MSB)	
TxIN18	Hs	Horizontal sync	
TxIN19	Vs	Vertical sync	
TxIN20	DE	Data enable	
TxCLKIN	CLK	Clock	Dot clock

2. Absolute maximum ratings

(GND = 0 V)

Parameter	Symbol	Values		Unit	Remark
		Min.	Max.		
Power voltage	$V_{CC}$	-0.3	4	$V_{DC}$	At 25°C
Input signal voltage	$V_{LH}$	-0.3	$V_{CC}+0.3$	$V_{DC}$	At 25°C
Operating temperature	$T_{op}$	0	+50	°C	Note 1
Storage temperature	$T_{ST}$	-20	+60	°C	Note 1

Note 1: The relative humidity must not exceed 90% non-condensing at temperatures of 40°C or less. At temperatures greater than 40°C, the wet bulb temperature must not exceed 39°C. When operate at low temperatures, the brightness of CCFL will drop and the life time of CCFL will be reduced.

Note 2: The unit should not be exposed to corrosive chemicals.

3. Electrical characteristics

a. Typical operating conditions

	Item	Symbol	Min.	Typ.	Max.	Unit	Remark
Power supply voltage	Input voltage	$V_{CC}$	3.0	3.3	3.6	V	
	Current consumption	$I_A$	-	350	-		Note 1
		$I_B$	-	-	( 550 )	mArms	
	Inrush current	$I_{RUSH}$	-	-	2200	mApeak	Note 2
Internal logic	Low voltage	$V_{IL}$	0	-	$0.3 V_{CC}$		
	High voltage	$V_{IH}$	$0.7V_{CC}$	-	$V_{CC}$		
	Power ripple voltage	$V_{RP}$	-	-	100	mVp-p	

Note 1: Effective value (mArms) at  $V_{CC} = 3.3 V/25^{\circ}C$ .

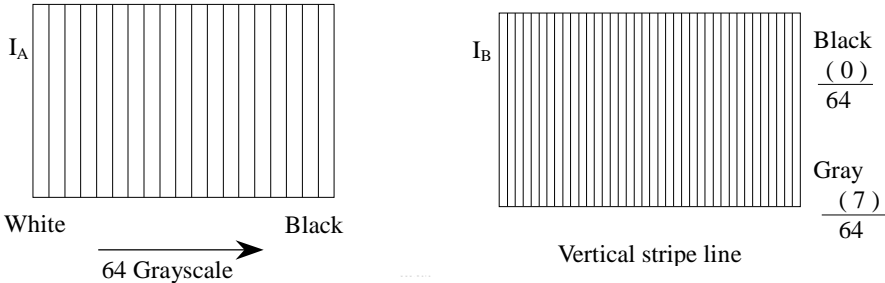

Note 2: Refer to the following power-on condition.

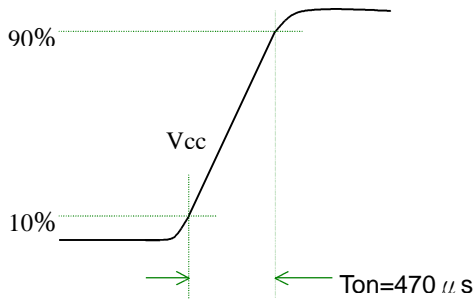

Sequence of Power-on/off and signal-on/off

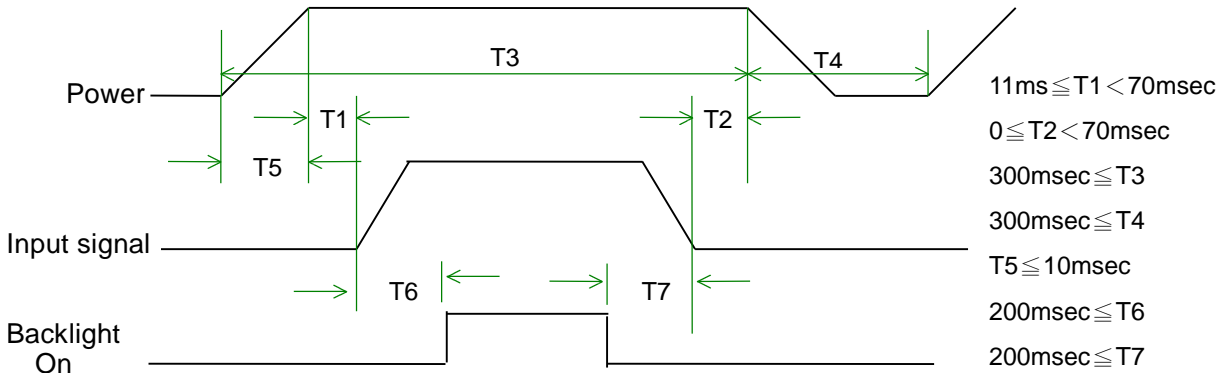

Apply the lamp voltage within the LCD operating range. When the backlight turns on before the LCD operation or the LCD turns off before the backlight turns off, the display may momentarily become abnormal.

**Caution**

The above on/off sequence should be applied to avoid abnormal function in the display.  
 In case of handling:  
 Make sure to turn off the power when you plug the cable into the input connector or pull the cable out of the connector.

b. Display color v.s. input data signals

Display colors		Data signal (0 : Low level, 1: High level)																	
		R5	R4	R3	R2	R1	R0	G5	G4	G3	G2	G1	G0	B5	B4	B3	B2	B1	B0
Basic colors	Black	0	0	0	0	0	0	0	0	0	0	0	0	0	0	0	0	0	0
	Blue	0	0	0	0	0	0	0	0	0	0	0	0	1	1	1	1	1	1
	Red	1	1	1	1	1	1	0	0	0	0	0	0	0	0	0	0	0	0
	Magenta	1	1	1	1	1	1	0	0	0	0	0	0	1	1	1	1	1	1
	Green	0	0	0	0	0	0	1	1	1	1	1	1	0	0	0	0	0	0
	Cyan	0	0	0	0	0	0	1	1	1	1	1	1	1	1	1	1	1	1
	Yellow	1	1	1	1	1	1	1	1	1	1	1	1	0	0	0	0	0	0
	White	1	1	1	1	1	1	1	1	1	1	1	1	1	1	1	1	1	1
Red grayscale	Black	0	0	0	0	0	0	0	0	0	0	0	0	0	0	0	0	0	0
		0	0	0	0	0	1	0	0	0	0	0	0	0	0	0	0	0	0
	Dark	0	0	0	0	1	0	0	0	0	0	0	0	0	0	0	0	0	0
	↑																		
	↓																		
	bright	1	1	1	1	0	1	0	0	0	0	0	0	0	0	0	0	0	0
	1	1	1	1	1	0	0	0	0	0	0	0	0	0	0	0	0	0	
	Red	1	1	1	1	1	1	0	0	0	0	0	0	0	0	0	0	0	
Green grayscale	Black	0	0	0	0	0	0	0	0	0	0	0	0	0	0	0	0	0	0
		0	0	0	0	0	0	0	0	0	0	0	1	0	0	0	0	0	0
	Dark	0	0	0	0	0	0	0	0	0	1	0	0	0	0	0	0	0	0
	↑																		
	↓																		
	bright	0	0	0	0	0	0	1	1	1	1	0	1	0	0	0	0	0	0
	0	0	0	0	0	0	1	1	1	1	1	0	0	0	0	0	0	0	
	Green	0	0	0	0	0	1	1	1	1	1	1	0	0	0	0	0	0	
Blue grayscale	Black	0	0	0	0	0	0	0	0	0	0	0	0	0	0	0	0	0	0
		0	0	0	0	0	0	0	0	0	0	0	0	0	0	0	0	0	1
	Dark	0	0	0	0	0	0	0	0	0	0	0	0	0	0	0	0	1	0
	↑																		
	↓																		
	bright	0	0	0	0	0	0	0	0	0	0	0	0	1	1	1	1	0	1
	0	0	0	0	0	0	0	0	0	0	0	0	1	1	1	1	1	0	
	Blue	0	0	0	0	0	0	0	0	0	0	0	1	1	1	1	1	1	

Note : Each basic color can be displayed in 64 gray scales using the 6 bit data signals. By combining the 18-bit data signals(R,G,B), the 262, 144 colors can be achieved on the



display.

ALL RIGHTS STRICTLY RESERVED. ANY PORTION OF THIS PAPER SHALL NOT BE REPRODUCED, COPIED, OR TRANSFORMED TO ANY OTHER FORMS WITHOUT PERMISSION FROM AU OPTRONICS CORP.

SPEC NO. : 413-212-067

PAGE : 7/16

c. Input signal timing

Timing diagrams of input signal are shown in Fig 2.

(1). Timing characteristics of input signals

	Item	Symbol	Min.	Typ.	Max.	Unit	Remark
CLK clock	Frequency	Fck	50	65	66	MHz	
	Period	Clk	15.2	15.4	20	ns	
Hs Horizontal sync	Period	Th	1040	1344	1648	Clk	
			20	20.7	-	$\mu$ s	
	Display period	Thd	1024			Clk	
	Pulse width	Thw	2	136	-	Clk	
	Display start	The	296	296	296	Clk	DE non-using
			8	296	600	Clk	DE using
	Front porch	Thf	8	24	-	Clk	
	Back porch	Thb	4	160	-	Clk	
Blanking	Thb1	16	320	624	Clk		
Vs Vertical sync	Phase shift	Tvpd	2	320	-	Clk	
	Period	Tv	803	806	895	Th	
			-	16.6	20	ms	
	Display width	Tvd	768			Th	
	Pulse width	Tvw	1	6	-	Th	
	Display start	Tve	-	35	-	Th	DE non-using
	Front porch	Tvf	0	3	-	Th	
Blanking	Tvb1	35	38	127	Th		

Available data input timing

Horizontal	DE non-using	When DE signal is fixed Low, after falling edge of Hs, counting 296 clocks, then getting valid data from 297th clock's data.
	DE using	Valid data is according to rising edge of "DE" signal. The time should be 8 to 600 clocks between falling edge of Hs and rising edge of DE.
Vertical	DE non-using	After falling edge of Vs, counting 35 Th, then getting 36th Th 's data. (in DE non-using mode and DE using mode).
	DE using	Valid data is according to the first rising edge of "DE" signal after DE keeps low during blanking period.

(2). The timing condition of LVDS

Item	Symbol	Min.	Typ.	Max.	Unit
The differential level	$ VID $	0.1	-	0.6	V
The common mode input voltage	VIC	$\frac{ VID }{2}$	-	$2.4 - \frac{ VID }{2}$	V
The input setup time	tsu1	500	-	-	ps
The input hold time	th1	500	-	-	ps

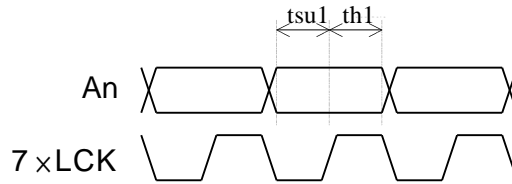
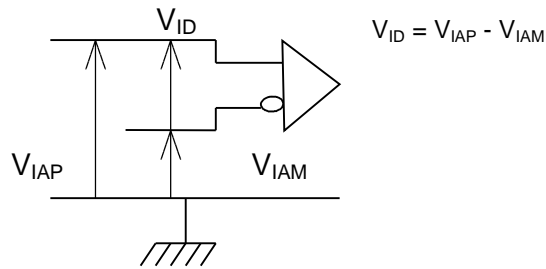

d. Display position

D( 1,1 )	D( 2,1 )	.....	D( X,1 )	.....	D( 1023,1 )	D( 1024,1 )
D( 1,2 )	D( 2,2 )	.....	D( X,2 )	.....	D( 1023,2 )	D( 1024,2 )
⋮		.....	⋮	.....	⋮	⋮
D( 1,Y )	D( 2,Y )	.....	D( X,Y )	.....	D( 1023,Y )	D( 1024,Y )
⋮		.....	⋮	.....	⋮	⋮
D( 1,767 )	D( 2,767 )	.....	D( X,767 )	.....	D( 1023,767 )	D( 1024,767 )
D( 1,768 )	D( 2,768 )	.....	D( X,768 )	.....	D( 1023,768 )	D( 1024,768 )

e.Backlight driving conditions

Parameter	Symbol	Min.	Typ.	Max.	Unit	Remark
Lamp voltage	$V_L$	594	660	726	Vrms	Note 1
Lamp current	$I_L$	3	6	6.5	mArms	Note 1
Power consumption	$P_L$		3.96		W	Note 2
Lamp starting voltage	$V_S$	-	-	1530	Vrms	T=0°C
		-	-	925		T=25°C
Frequency	$F_L$	50	60	80	KHz	Note 3
Lamp life time	$L_L$	10000	-	-	Hr	Note 1, 4

Note 1: T= 25°C,  $I_L$  = 6mA.

Note 2: Inverter should be designed with the characteristic of lamp. When you are designing the inverter, the output voltage of the inverter should comply with the following conditions.

- (1).The area under the positive and negative cycles of the waveform of the lamp current and lamp voltage should be area symmetric(the symmetric ratio should be larger than 90%).
- (2).There should not have any spikes in the waveform.
- (3).The waveform should be sine wave as possible.
- (4).Lamp current should not exceed the maximum value within the operating temperature (It is prohibited to over the maximum lamp current even if operated in the non-guaranteed temperature). When lamp current over the maximum value for a long time, it may cause fire. Therefore, it is recommend that the inverter should have the current limiter circuit.

Note 3: Lamp frequency may produce interference with horizontal synchronous frequency and this may cause line flow on the display. Therefore lamp frequency shall be detached from the horizontal synchronous frequency and its harmonics as far as possible in order to avoid interference. In case using the inverter by PWM control, PWM frequency may interference with frame frequency. We suggest that PWM frequency is same as frame frequency.

Note 4: Brightness to be decrease to the 50% of the initial value.

Note 5: CN2 connector(backlight): BHSR-02VS-1(JST).

Mating connector: SM02B-BHSS-1-TB (JST).

Pin no.	Symbol	Function	Remark
1	H	CCFL power supply(H.V.)	Cable color: Pink
2	L	CCFL power supply(GND)	Cable color: White

**C. Optical specifications ( Note 1, Note 2, Note 3 )**

Item	Symbol	Condition	Specification			Unit	Remark
			Min.	Typ.	Max.		
Response time							
Rising time	Tr	$\theta = 0^\circ$	-	20	40	ms	Note 4
Falling time	Tf		-	30	50		
Contrast ratio	CR	$\theta = 0^\circ$	150	200	-		Note 5
Viewing angle						deg.	Note 8
Top		$CR \geq 10$	15	-	-		
Bottom			35	-	-		
Left			40	-	-		
Right			40	-	-		
Brightness	5 points	$Y_L$	$\theta = 0^\circ$	120	(150)	-	Note 6,7,9
Color chromaticity(CIE)	Wx	$\theta = 0^\circ$		0.280	0.310	0.340	
	Wy			0.300	0.330	0.360	
	Rx			0.547	0.577	0.607	
	Ry			0.298	0.328	0.358	
	Gx			0.270	0.300	0.330	
	Gy			0.545	0.575	0.605	
	Bx			0.115	0.145	0.175	
	By			0.090	0.120	0.150	
White uniformity	$\delta_w$			-	-	1.6	Note 9

Note 1: Ambient temperature = 25°C.

Note 2: To be measured in dark room after backlight warm up 30 minutes.

Note 3: To be measured with a viewing cone of 1° by Topcon luminance meter BM-5A.

Note 4: Definition of response time:(To be measured by Topcon BM-5A)

The output signals of photodetector are measured when the input signals are changed from "Black" to "White" (falling time) and from "White" to "Black" (rising time), respectively. The response time interval between the 10% and 90% of amplitudes. Refer to figure as below.

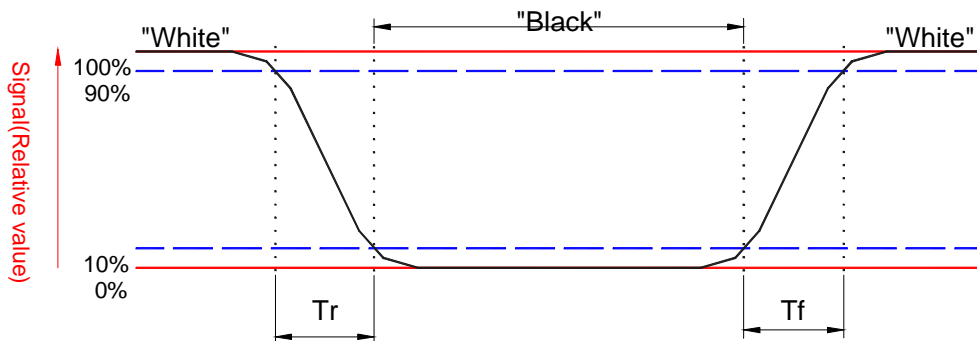

Note 5. Definition of contrast ratio:

Contrast ratio is calculated with the following formula.

$$\text{Contrast ratio (CR)} = \frac{\text{Photodetector output when LCD is at "White" state}}{\text{Photodetector output when LCD is at "Black" state}}$$

Note 6: Definition of brightness:

$$\text{Brightness( } Y_L) = \frac{Y_{LD} + Y_{LE} + Y_{LG} + Y_{LI} + Y_{LJ}}{5}$$

Note 7: Driving conditions for CCFT :  $I_L = (6.0) \text{ mA}$

Note 8: Definition of viewing angle(To be measure at display center by LCD-7000):

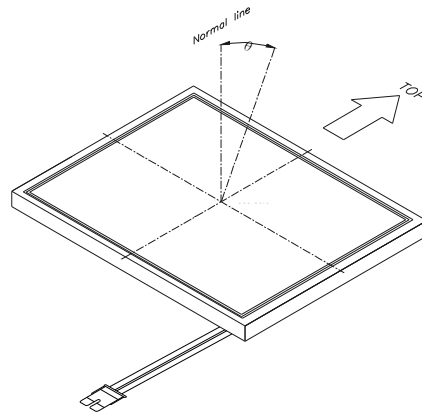

Note 9: Definition of white uniformity:

White uniformity is defined as the following with thirteen measurements (A~M).

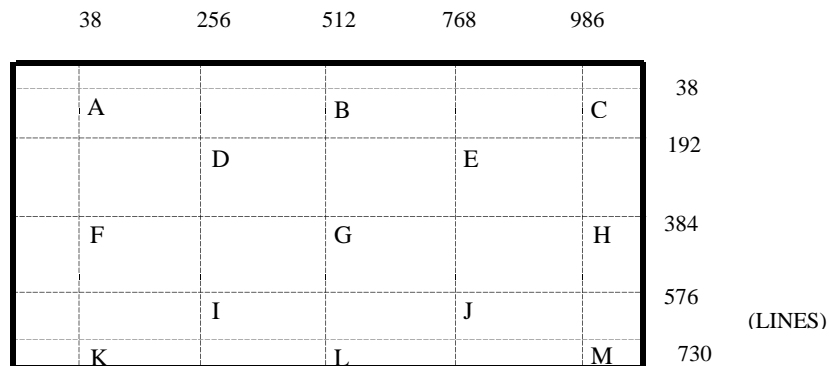

$$\delta_w = \frac{\text{Maximum Luminance of thirteen points(brightness)}}{\text{Minimum Luminance of thirteen points(brightness)}}$$

**D. Reliability test items(Note 1)**

Test tem	Test Condition	judgement	Remark
High temperature storage	60°C, 240Hrs	Display quality	Note 1, 2
Low temperature storage	-20°C, 240Hrs	Display quality	Note 1, 2
High temperature & high humidity operation	40°C, 90%RH, 240Hrs (No condensation)	Display quality	Note 1, 2
High temperature operation	50°C, 240Hrs	Display quality	Note 1, 2
Low temperature operation	0°C, 240Hrs	Display quality	Note 1, 2
Temperature cycling (non-operation)	-20°C ~60°C 1H. 10mins. 1H. 5cvcles	Display quality	Note 1, 2
Electrostatic discharge (non-operation)	150PF, 150Ω, ±10KV, 1second, 9 points on the panel, 10 times each place	Display function	Note 3
Vibration (non-operation)	Sweep:1G, 10Hz ~ 500Hz ~ 10Hz /2.5min 2 hour for each direction X, Y, Z	Display quality	Note 1, 2
Mechanical shock (non-operation)	50G, 11ms, ±X, ±Y, ±Z once for each direction	Display quality	Note 1, 2

Note 1: Evaluation should be tested after storage at room temperature for one hour.

Note 2: There should be no change which might affect the practical display function when the display quality test is conducted under normal operating condition.

Note 3: The discharging points are shown as below.

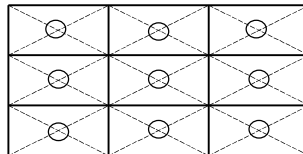

**E. Display quality**

The display quality of the color TFT-LCD module should be in compliance with the Unipac's incoming inspection standard.

**F. Handling precaution**

The Handling of the TFT-LCD should be in compliance with the Unipac's handling principle standard.

ALL RIGHTS STRICTLY RESERVED. ANY PORTION OF THIS PAPER SHALL NOT BE REPRODUCED, COPIED, OR TRANSFORMED TO ANY OTHER FORMS WITHOUT PERMISSION FROM AU OPTRONICS CORP.

SPEC NO. : 413-212-067

PAGE : 13/16

**G. Packing form**

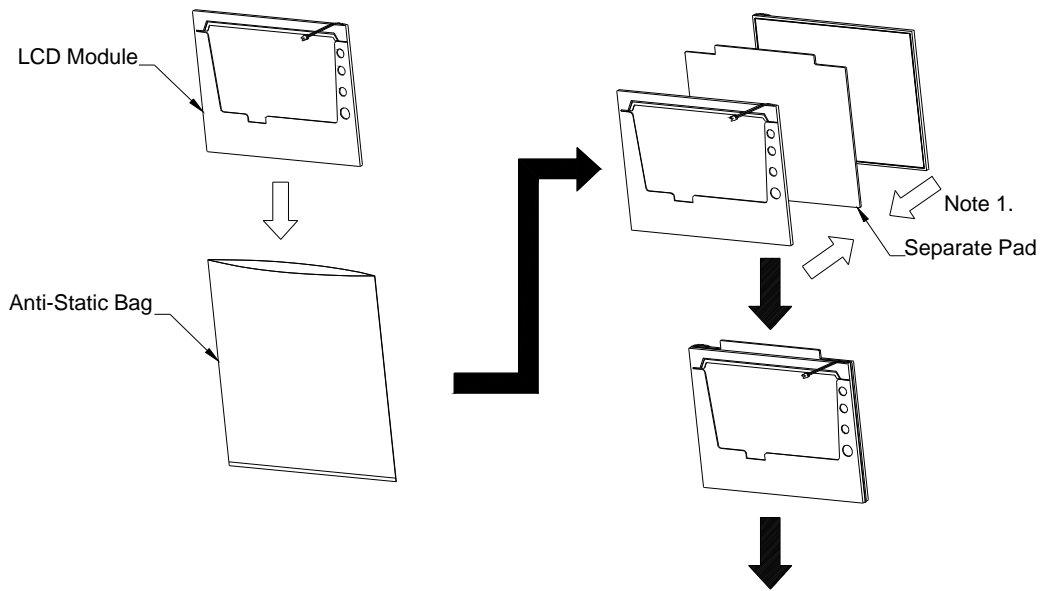

Note :

- 1.The panel of each LCD Module faces toward seperation pad.
- 2.Max. capacity : 20 LCD Modules/Carton.
- 3.Max. weight : 15kg/Carton.
- 4.Meas. : 458mm\*412mm\*365mm.

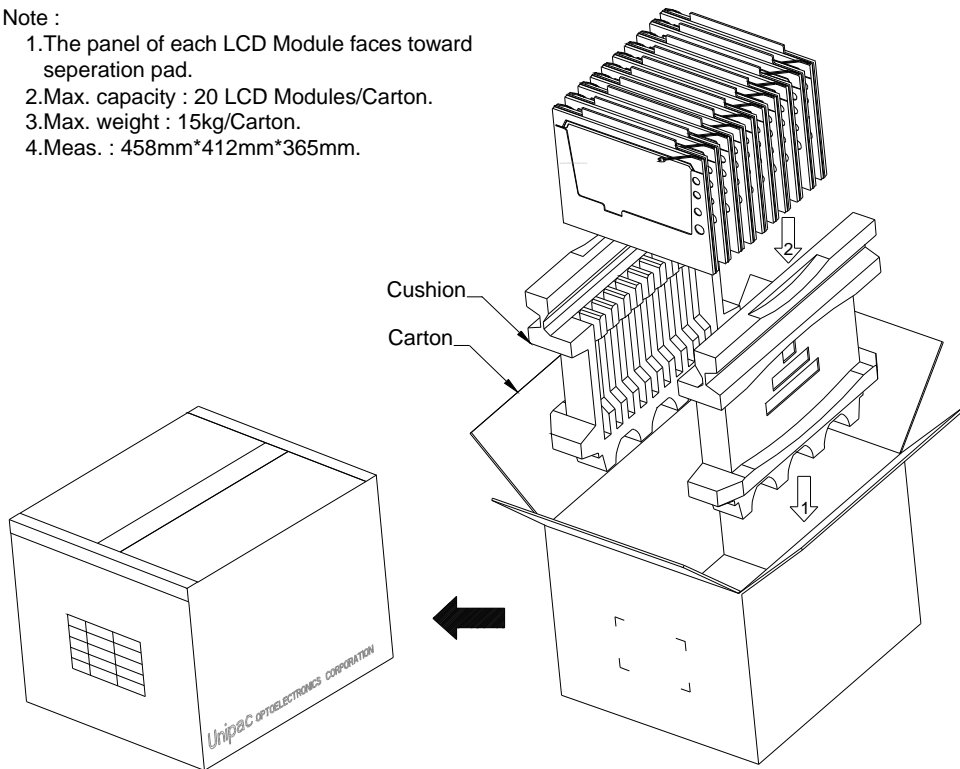

ALL RIGHTS STRICTLY RESERVED. ANY PORTION OF THIS PAPER SHALL NOT BE REPRODUCED, COPIED, OR TRANSFORMED TO ANY OTHER FORMS WITHOUT PERMISSION FROM AU OPTRONICS CORP.

SPEC NO. : 413-212-067

PAGE : 14/16



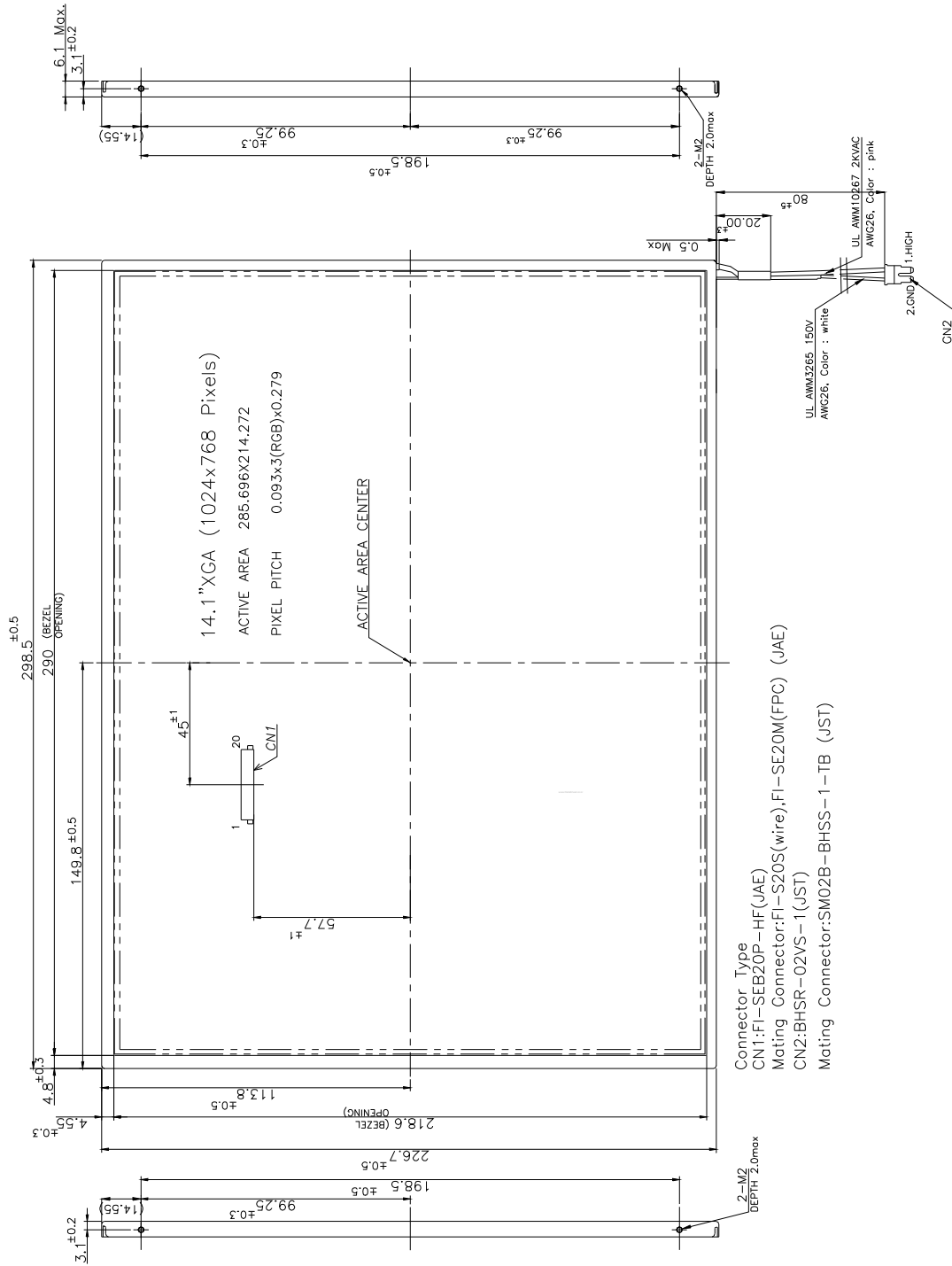

**Fig.1-(a) LCM outline dimensions (Front side)**

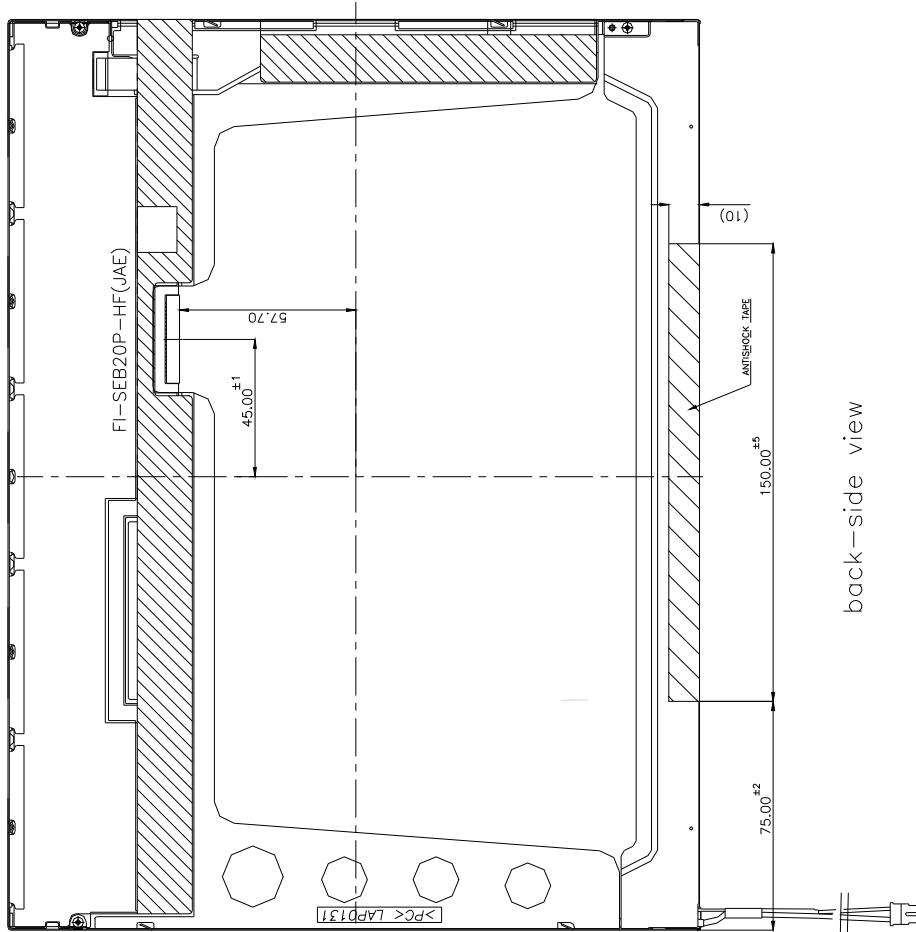

**Fig.1-1-(b) LCM outline dimensions (Back side)**

ALL RIGHTS STRICTLY RESERVED. ANY PORTION OF THIS PAPER SHALL NOT BE REPRODUCED, COPIED, OR TRANSFORMED TO ANY OTHER FORMS WITHOUT PERMISSION FROM AU OPTRONICS CORP.

SPEC NO. : 413-212-067

PAGE : 16/16

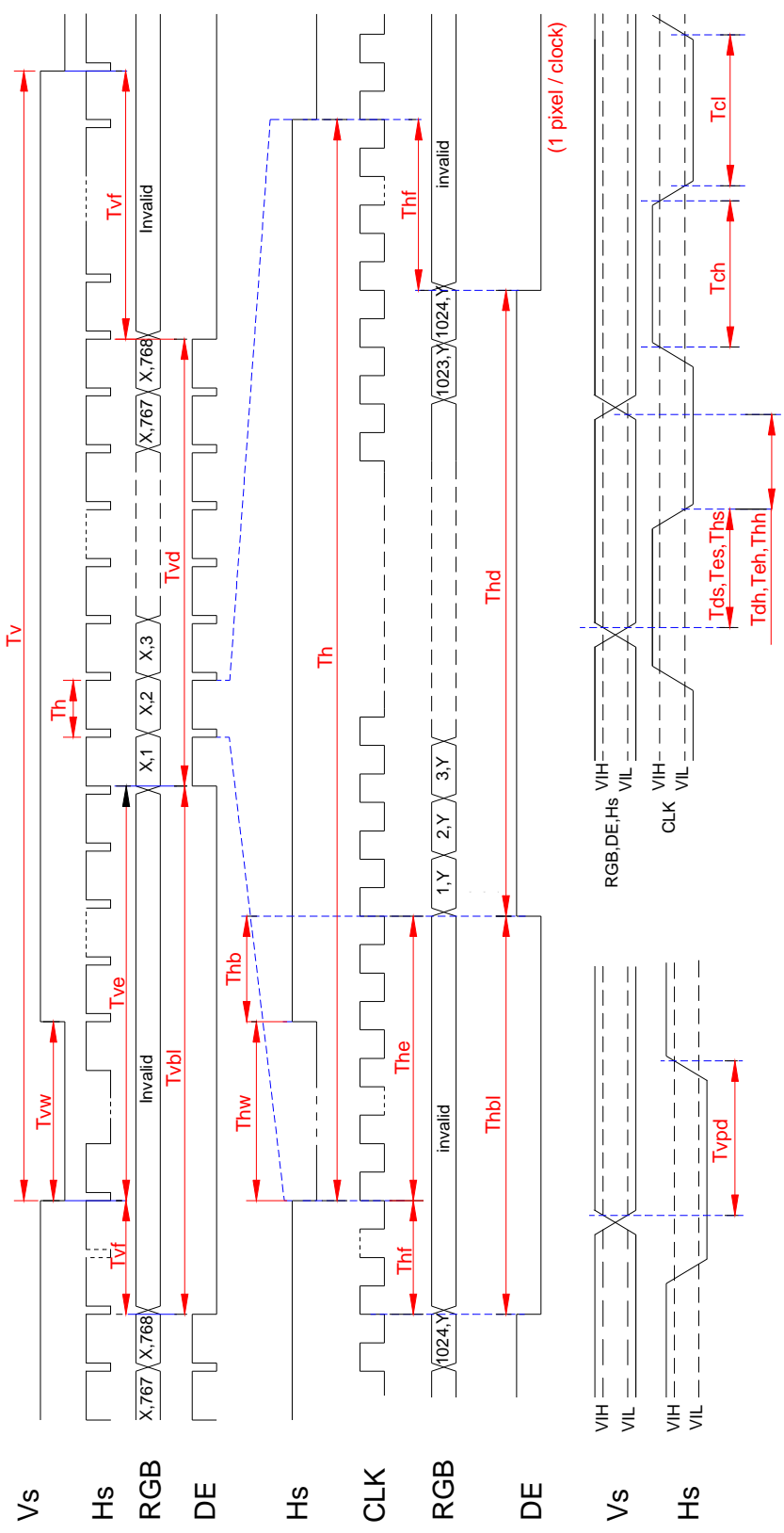

Fig.2 Timing chart

ALL RIGHTS STRICTLY RESERVED. ANY PORTION OF THIS PAPER SHALL NOT BE REPRODUCED, COPIED, OR TRANSFORMED TO ANY OTHER FORMS WITHOUT PERMISSION FROM AU OPTONICS CORP.