



# Product Specification

AU OPTRONICS CORPORATION

( V ) Preliminary Specifications

( ) Final Specifications

<b>Module</b>	15.4" WXGA Color TFT-LCD
<b>Model Name</b>	B154EW09 V2 (HW:1A)
<b>Note</b> (  )	<i>LED Backlight without driving circuit design</i>

<b>Customer</b>	<b>Date</b>
<b>Checked &amp; Approved by</b>	<b>Date</b>
_____	_____

Note: This Specification is subject to change without notice.

<b>Approved by</b>	<b>Date</b>
_____	_____
<b>Prepared by</b>	
_____	_____

**NBBU Marketing Division / AU Optronics corporation**



Contents

**1. Handling Precautions ..... 4**

**2. General Description ..... 5**

    2.1 General Specification ..... 5

    2.2 Optical Characteristics ..... 6

**3. Functional Block Diagram ..... 11**

**4. Absolute Maximum Ratings..... 12**

    4.1 Absolute Ratings of TFT LCD Module ..... 12

    4.2 Absolute Ratings of Environment ..... 12

**5. Electrical characteristics ..... 13**

    5.1 TFT LCD Module..... 13

    5.2 Backlight Unit ..... 15

**6. Signal Characteristic ..... 16**

    6.1 Pixel Format Image ..... 16

    6.2 The input data format ..... 17

    6.3 Signal Description/Pin Assignment..... 18

    6.4 Interface Timing ..... 21

**7. Connector Description..... 23**

    7.1 TFT LCD Module..... 23

**8. LED Driving Specification ..... 24**

    8.1 Backlight connection ..... 24

    8.2 Pin Assignment..... 24

**9. Vibration and Shock Test ..... 25**

    9.1 Vibration Test ..... 25

    9.2 Shock Test Spec:..... 25

**10. Reliability..... 26**

**11. Mechanical Characteristics..... 27**

    11.1 LCM Outline Dimension ..... 27

    11.2 Screw Hole Depth and Center Position ..... 29

**12. Shipping and Package ..... 30**

    12.1 Shipping Label Format ..... 30

    12.2 Carton package ..... 31

    12.3 Shipping package of palletizing sequence..... 31

**13. Appendix: EDID description ..... 32**



# Product Specification

AU OPTRONICS CORPORATION

## Record of Revision

Version and Date	Page	Old description	New Description	Remark
0.1 2008/06/16	All	First Edition for Customer		
0.2 2008/07/30	P6 P12, P15	Chromaticity: Gy:0.575; By:0.120 4.2 Absolute Ratings of Backlight Unit	Chromaticity: Gy:0.580; By:0.110 Combine the description of LED characteristics to 5.2 Backlight Unit	
0.3 2008/08/01	P5	Power consumption: 5.7 max	Power consumption: 4.9 max	

## 1. Handling Precautions

- 1) Since front polarizer is easily damaged, pay attention not to scratch it.
- 2) Be sure to turn off power supply when inserting or disconnecting from input connector.
- 3) Wipe off water drop immediately. Long contact with water may cause discoloration or spots.
- 4) When the panel surface is soiled, wipe it with absorbent cotton or other soft cloth.
- 5) Since the panel is made of glass, it may break or crack if dropped or bumped on hard surface.
- 6) Since CMOS LSI is used in this module, take care of static electricity and insure human earth when handling.
- 7) Do not open nor modify the Module Assembly.
- 8) Do not press the reflector sheet at the back of the module to any directions.
- 9) At the insertion or removal of the Signal Interface Connector, be sure not to rotate nor tilt the Interface Connector of the TFT Module.
- 11) After installation of the TFT Module into an enclosure (Notebook PC Bezel, for example), do not twist nor bend the TFT Module even momentary. At designing the enclosure, it should be taken into consideration that no bending/twisting forces are applied to the TFT Module from outside. Otherwise the TFT Module may be damaged.
- 12) Small amount of materials having no flammability grade is used in the LCD module. The LCD module should be supplied by power complied with requirements of Limited Power Source (IEC60950 or UL1950), or be applied exemption.
- 13) Disconnecting power supply before handling LCD modules, it can prevent electric shock, DO NOT TOUCH the electrode parts, cables and connectors of TFT module that a LED light bar build in as a light source of back light unit. It can prevent electrostatic breakdown.

## 2. General Description

B154EW09 V2 is a Color Active Matrix Liquid Crystal Display composed of a TFT LCD panel, a driver circuit, and LED backlight system. The screen format is intended to support the WXGA (1280(H) x 800(V)) screen and 262k colors (RGB 6-bits data driver) without LED backlight driving circuit. All input signals are LVDS interface compatible.

B154EW09 V2 is designed for a display unit of notebook style personal computer and industrial machine.

### 2.1 General Specification

The following items are characteristics summary on the table at 25 °C condition:

Items	Unit	Specifications			
Screen Diagonal	[mm]	391 (15.4W")			
Active Area	[mm]	331.2 X 207.0			
Pixels H x V		1280x3(RGB) x 800			
Pixel Pitch	[mm]	0.2588X0.2588			
Pixel Format		R.G.B. Vertical Stripe			
Display Mode		Normally White			
White Luminance ( <b>I<sub>LED</sub>=20mA</b> ) (Note: I <sub>LED</sub> is LED current)	[cd/m <sup>2</sup> ]	220 typ. (5 points average) 187 min. (5 points average)			
Luminance Uniformity		1.25 max. (5 points)			
Contrast Ratio		500 typ ,			
Response Time	[ms]	8 typ / 15 Max			
Nominal Input Voltage VDD	[Volt]	+3.3 typ.			
Power Consumption	[Watt]	4.9 max. (Include Logic and Blu power)			
Weight	[Grams]	460 max.			
Physical Size	[mm]		L	W	T
		Max	344.5	222.5	5.7
		Typical	344.0	222.0	-
		Min	343.5	221.5	-
Electrical Interface		1 channel LVDS			
Surface Treatment		Glare, Hardness 3H,			
Support Color		262K colors ( RGB 6-bit )			

Temperature Range Operating	[°C]	0 to +50
Storage (Non-Operating)	[°C]	-20 to +60
RoHS Compliance		RoHS Compliance

## 2.2 Optical Characteristics

The optical characteristics are measured under stable conditions at 25°C (Room Temperature) :

Item	Symbol	Conditions	Min.	Typ.	Max.	Unit	Note
White Luminance I <sub>LED</sub> =20mA		5 points average	187	220	-	cd/m <sup>2</sup>	1, 4, 5.
Viewing Angle	$\theta_R$	Horizontal (Right) CR = 10 (Left)	40	45	-	degree	4, 9
	$\theta_L$		40	45	-		
	$\phi_H$	Vertical (Upper) CR = 10 (Lower)	10	15	-		
	$\phi_L$		30	35	-		
Luminance Uniformity	$\delta_{5P}$	5 Points	-	-	1.25		1, 3, 4
Luminance Uniformity	$\delta_{13P}$	13 Points	-	-	1.50		2, 3, 4
Contrast Ratio	CR		400	500	-		4, 6
Cross talk	%				4		4, 7
Response Time	T <sub>r</sub>	Rising	-	TBD	-	msec	4, 8
	T <sub>f</sub>	Falling	-	TBD	-		
	T <sub>RT</sub>	Rising + Falling	-	8	16		
Color / Chromaticity Coordinates	Red	R <sub>x</sub>	CIE 1931	0.540	0.590	0.640	4
		R <sub>y</sub>		0.295	0.345	0.395	
	Green	G <sub>x</sub>		0.290	0.340	0.390	
		G <sub>y</sub>		0.530	0.580	0.630	
	Blue	B <sub>x</sub>		0.100	0.150	0.200	
		B <sub>y</sub>		0.060	0.110	0.160	
	White	W <sub>x</sub>		0.263	0.313	0.363	
		W <sub>y</sub>		0.279	0.329	0.379	
	NTSC	%			-	45	

**Note 1:** 5 points position (Ref: Active area)

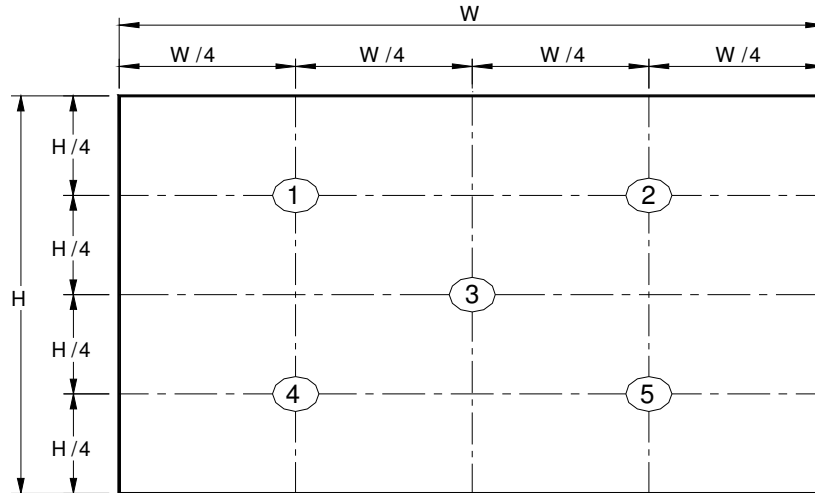

**Note 2:** 13 points position (Ref: Active area)



**Note 3:** The luminance uniformity of 5 or 13 points is defined by dividing the maximum luminance values by the minimum test point luminance

$$\delta_{w5} = \frac{\text{Maximum Brightness of five points}}{\text{Minimum Brightness of five points}}$$

$$\delta_{w13} = \frac{\text{Maximum Brightness of thirteen points}}{\text{Minimum Brightness of thirteen points}}$$

**Note 4:** Measurement method

The LCD module should be stabilized at given temperature for 30 minutes to avoid abrupt temperature change during measuring. In order to stabilize the luminance, the measurement should be executed after lighting

Backlight for 30 minutes in a stable, windless and dark room, and it should be measured in the center of screen.

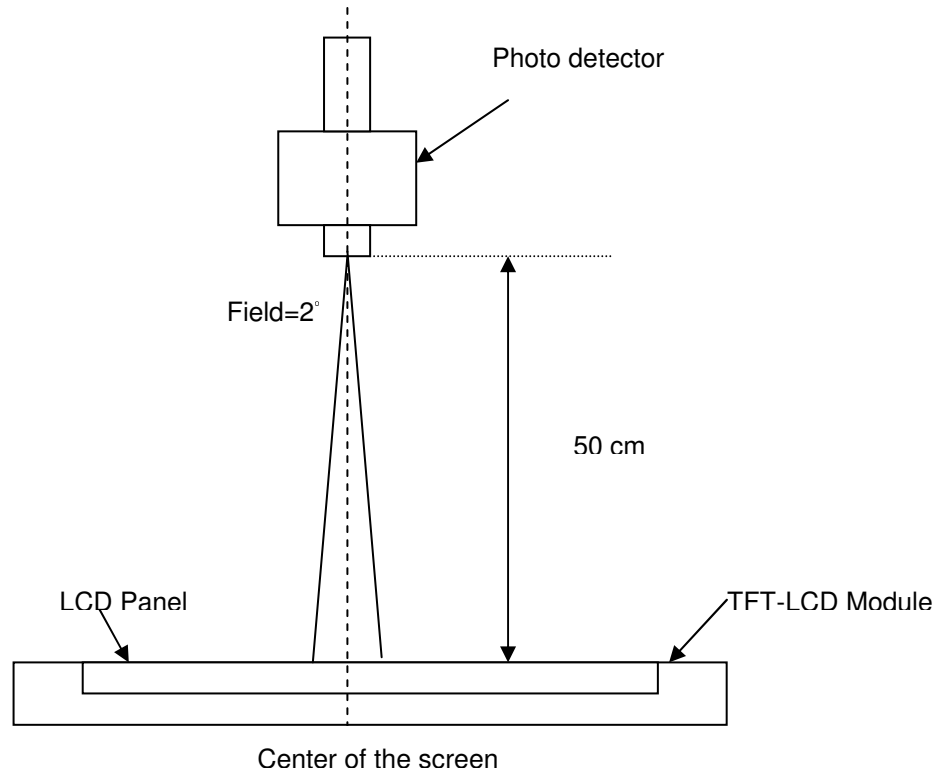

**Note 5 :** Definition of Average Luminance of White ( $Y_L$ ):

Measure the luminance of gray level 63 at 5 points ·  $Y_L = [L(1) + L(2) + L(3) + L(4) + L(5)] / 5$

$L(x)$  is corresponding to the luminance of the point X at Figure in Note (1).

**Note 6 :** Definition of contrast ratio:

Contrast ratio is calculated with the following formula.

$$\text{Contrast ratio (CR)} = \frac{\text{Brightness on the "White" state}}{\text{Brightness on the "Black" state}}$$

**Note 7 :** Definition of Cross Talk (CT)

$$CT = |Y_B - Y_A| / Y_A \times 100 (\%)$$

Where

$Y_A$  = Luminance of measured location without gray level 0 pattern (cd/m<sup>2</sup>)

$Y_B$  = Luminance of measured location with gray level 0 pattern (cd/m<sup>2</sup>)



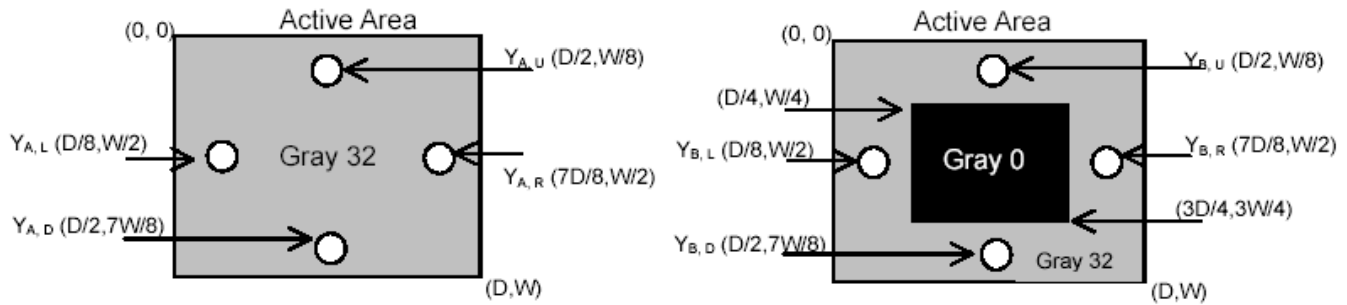

**Note 8:** Definition of response time:

The output signals of BM-7 or equivalent are measured when the input signals are changed from "Black" to "White" (falling time) and from "White" to "Black" (rising time), respectively. The response time interval between the 10% and 90% of amplitudes. Refer to figure as below.

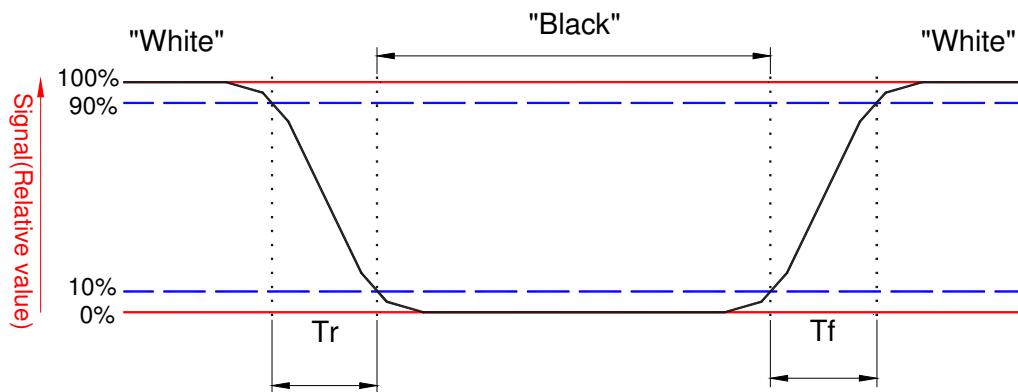

**Note 9.** Definition of viewing angle

Viewing angle is the measurement of contrast ratio  $\geq 10$ , at the screen center, over a  $180^\circ$  horizontal and  $180^\circ$  vertical range (off-normal viewing angles). The  $180^\circ$  viewing angle range is broken down as follows;  $90^\circ$  ( $\theta$ ) horizontal left and right and  $90^\circ$  ( $\phi$ ) vertical, high (up) and low (down). The measurement direction is typically perpendicular to the display surface with the screen rotated about its center to develop the desired measurement viewing angle.

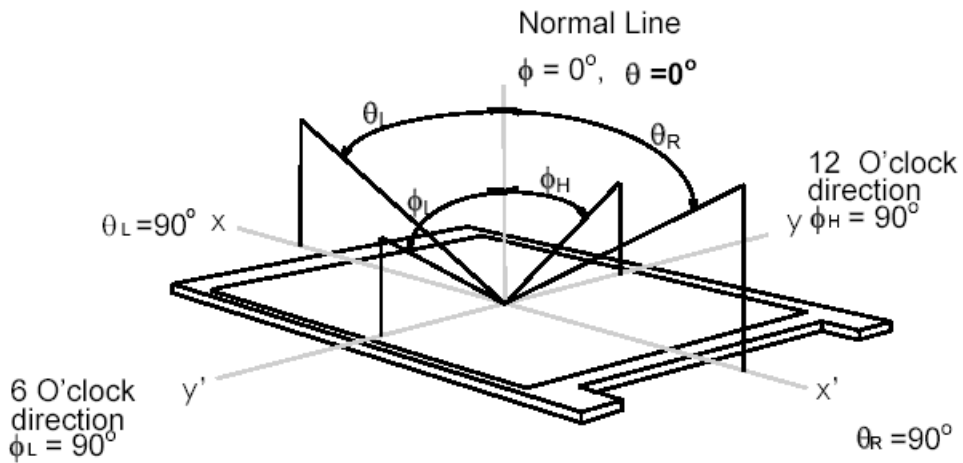

## 3. Functional Block Diagram

The following diagram shows the functional block of the 15.4 inches wide Color TFT/LCD Module:

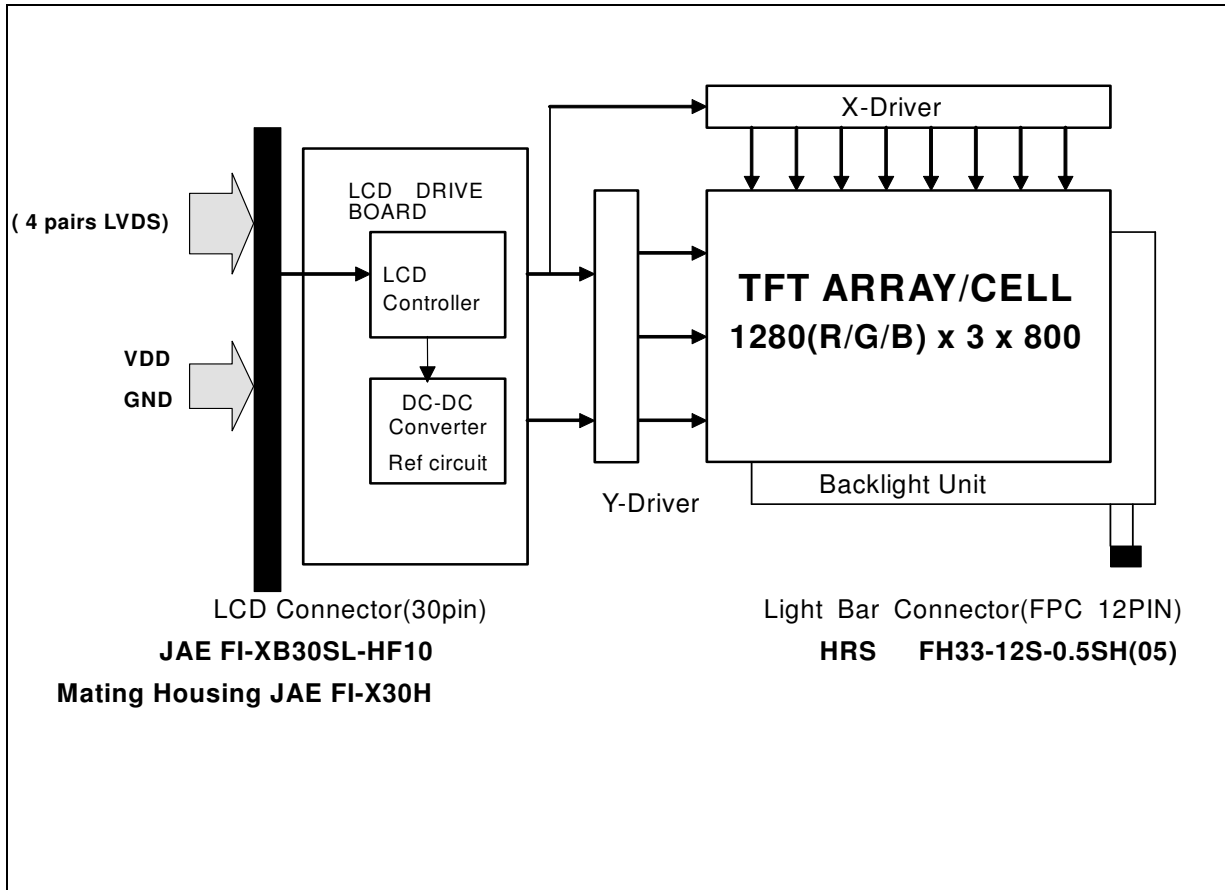

## 4. Absolute Maximum Ratings

An absolute maximum rating of the module is as following:

### 4.1 Absolute Ratings of TFT LCD Module

Item	Symbol	Min	Max	Unit	Conditions
Logic/LCD Drive Voltage	Vin	-0.3	+4.0	[Volt]	Note 1,2

### 4.2 Absolute Ratings of Environment

Item	Symbol	Min	Max	Unit	Conditions
Operating Temperature	TOP	0	+50	[°C]	Note 4
Operation Humidity	HOP	10	90	[%RH]	Note 4
Storage Temperature	TST	-20	+60	[°C]	Note 4
Storage Humidity	HST	10	90	[%RH]	Note 4

Note 1: At Ta (25°C )

Note 2: I<sub>LED</sub> =20mA

Note 3: LED specification refer to section 5.2

**Note 4: For quality performance, please refer to AUO IIS (Incoming Inspection Standard).**

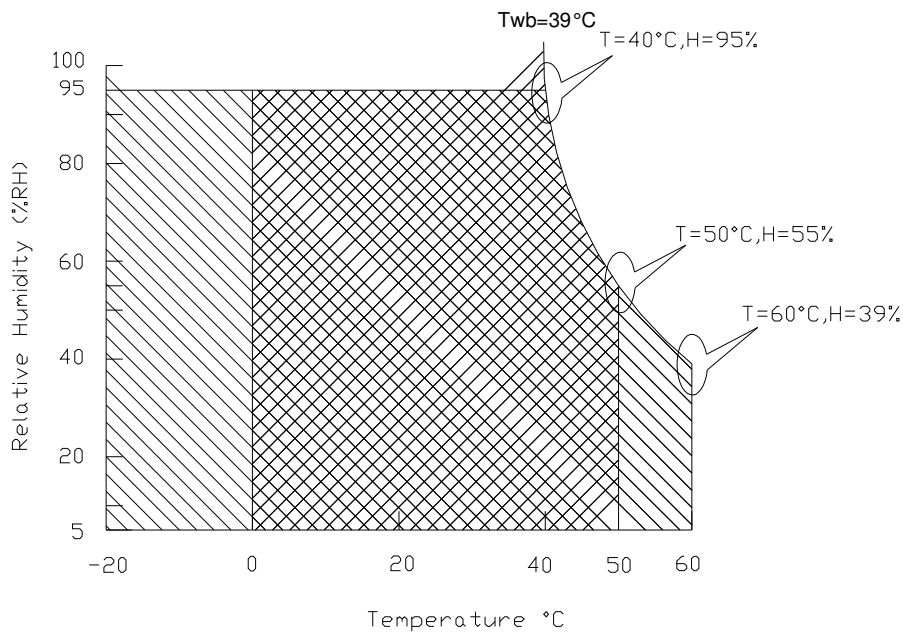

Operating Range

Storage Range

+

## 5. Electrical characteristics

### 5.1 TFT LCD Module

#### 5.1.1 Power Specification

Input power specifications are as follows;

Symble	Parameter	Min	Typ	Max	Units	Note
VDD	Logic/LCD Drive Voltage	3.0	3.3	3.6	[Volt]	
PDD	VDD Power	-	-	1.2	[Watt]	Note 1/2
IDD	IDD Current	-	-	363	[mA]	Note 1/2
IRush	Inrush Current	-	-	1500	[mA]	Note 3
VDDrp	Allowable Logic/LCD Drive Ripple Voltage	-	-	100	[mV] p-p	

Note 1 : Maximum Measurement Condition : Black Pattern

Note 2 : Typical Measurement Condition: Mosaic Pattern

Note 3 : Measure Condition

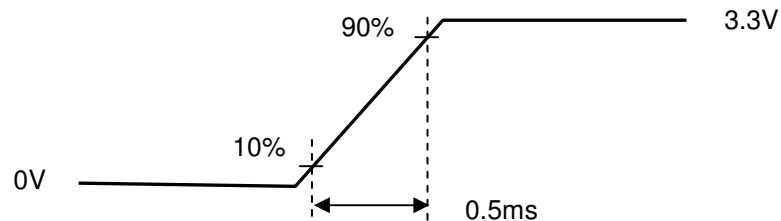
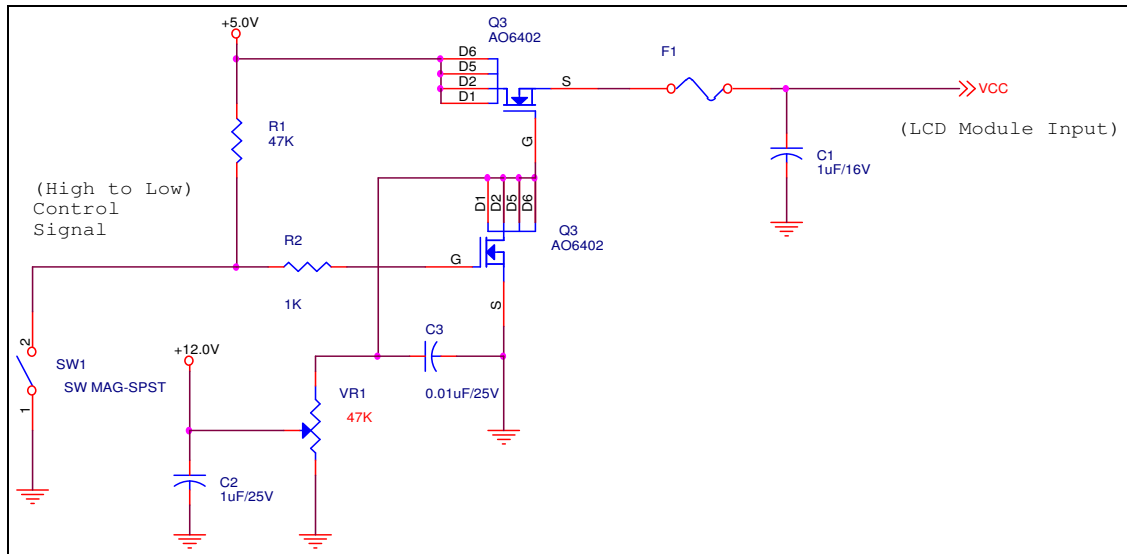

Vin rising time

## 5.1.2 Signal Electrical Characteristics

Input signals shall be low or High-impedance state when VDD is off.

It is recommended to refer the specifications of THC63LVDF84A (Thine Electronics Inc.) in detail.

Signal electrical characteristics are as follows;

Parameter	Condition	Min	Max	Unit
Vth	Differential Input High Threshold ( $V_{cm}=+1.2V$ )	-	100	[mV]
Vtl	Differential Input Low Threshold ( $V_{cm}=+1.2V$ )	-100	-	[mV]
Vcm	Differential Input Common Mode Voltage	1.125	1.375	[V]

Note: LVDS Signal Waveform

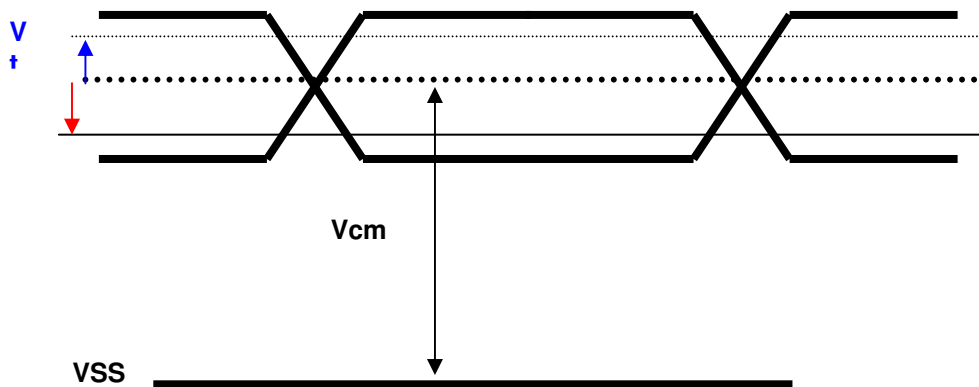

## 5.2 Backlight Unit

LED Parameter guideline for LED driving selection

Parameter	Symbol	Min	Typ	Max	Units	Condition
LED Forward Voltage	$V_F$	2.95	3.15	3.35	[Volt]	(Ta=25°C) Note 1
LED Forward Current	$I_F$		20	30	[mA]	(Ta=25°C) Note 1
LED Life-Time	N/A	10,000	-	-	Hour	(Ta=25°C) $I_F=20$ mA Note 2
LED Light bar Driving Voltage	$V_{LED}$	26.55	28.35	30.15	[Volt]	(Ta=25°C)
LED Light bar Driving Current	$I_{LED}$	-	120	180	[mA] rms	(Ta=25°C) $I_F=20$ mA

Note 1: Calculator value for LED chip specification

**Note 2:** The LED life-time define as the estimated time to 50% degradation of initial luminous.

## 6. Signal Characteristic

### 6.1 Pixel Format Image

Following figure shows the relationship of the input signals and LCD pixel format.

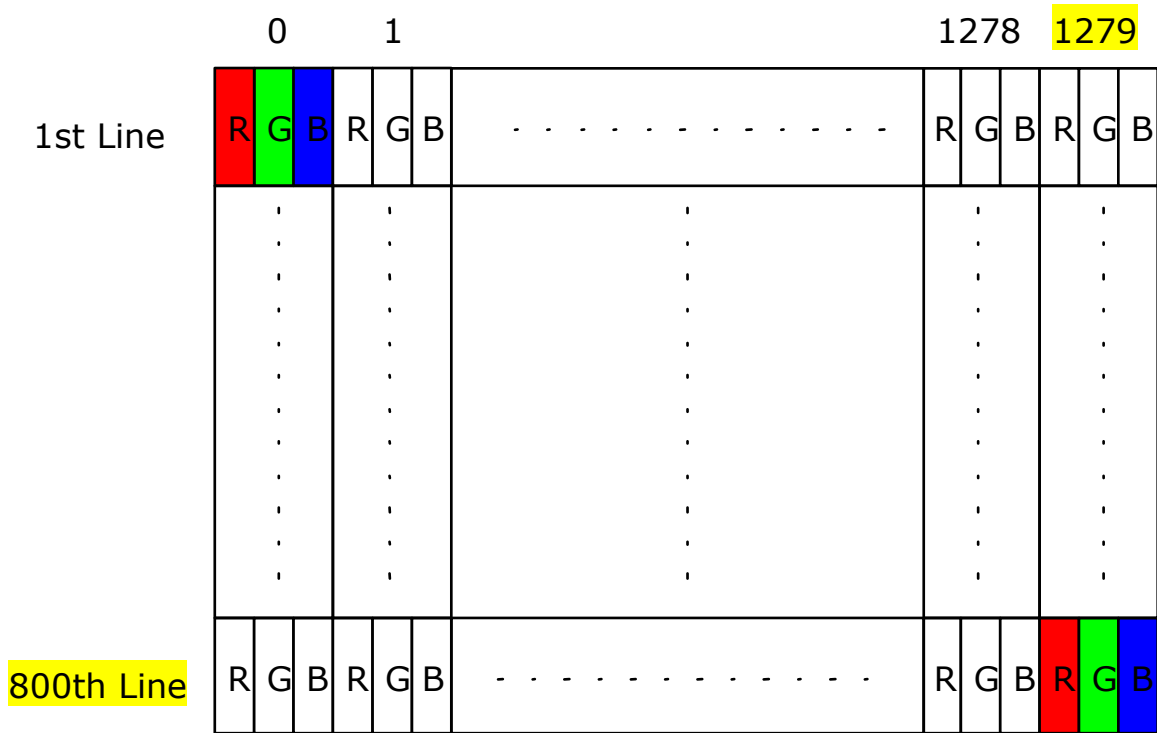



## 6.2 The input data format



Signal Name	Description	
R5 R4 R3 R2 R1 R0	Red Data 5 (MSB) Red Data 4 Red Data 3 Red Data 2 Red Data 1 Red Data 0 (LSB)	Red-pixel Data Each red pixel's brightness data consists of these 6 bits pixel data.
G5 G4 G3 G2 G1 G0	Green Data 5 (MSB) Green Data 4 Green Data 3 Green Data 2 Green Data 1 Green Data 0 (LSB)	Green-pixel Data Each green pixel's brightness data consists of these 6 bits pixel data.
B5 B4 B3 B2 B1 B0	Blue Data 5 (MSB) Blue Data 4 Blue Data 3 Blue Data 2 Blue Data 1 Blue Data 0 (LSB)	Blue-pixel Data Each blue pixel's brightness data consists of these 6 bits pixel data.
RxCLKIN	Data Clock	The max frequency is 72 MHZ.. The signal is used to strobe the pixel data and DE signals. All pixel data shall be valid at the falling edge when the DE signal is high.
DE	Display Timing	This signal is strobed at the falling edge of RxCLKIN. When the signal is high, the pixel data shall be valid to be displayed.
VS	Vertical Sync	The signal is synchronized to RxCLKIN .
HS	Horizontal Sync	The signal is synchronized to RxCLKIN .

Note: Output signals from any system shall be low or High-impedance state when VDD is off.



## 6.3 Signal Description/Pin Assignment

LVDS is a differential signal technology for LCD interface and high speed data transfer device.

PIN#	Signal Name	Description
1	GND	Ground
2	VDD	Power Supply +3.3V
3	VDD	Power Supply +3.3V
4	VEDID	EDID +3.3V Power
5	NC	No Connection (Reserve for AUO test)
6	CLKEDID	EDID Clock Input
7	DATAEDID	EDID Data Input
8	RxOIN0-	-LVDS Differential Data INPUT(Odd R0-R5,G0)
9	RxOIN0+	+LVDS Differential Data INPUT(Odd R0-R5,G0)
10	GND	Ground
11	RxOIN1-	-LVDS Differential Data INPUT(Odd G1-G5,B0-B1)
12	RxOIN1+	+LVDS Differential Data INPUT(Odd G1-G5,B0-B1)
13	GND	Ground
14	RxOIN2-	-LVDS Differential Data INPUT(Odd B2-B5,HS,VS,DE)
15	RxOIN2+	+LVDS Differential Data INPUT(Odd B2-B5,HS,VS,DE)
16	GND	Ground
17	RxCLKIN-	-LVDS Odd Differential Clock INPUT
18	RxCLKIN+	-LVDS Odd Differential Clock INPUT
19	GND	Ground
20	NC	No Connection (Reserve for AUO test)
21	NC	No Connection (Reserve for AUO test)
22	GND	Ground
23	NC	No Connection (Reserve for AUO test)
24	NC	No Connection (Reserve for AUO test)
25	GND	Ground
26	NC	No Connection (Reserve for AUO test)
27	NC	No Connection (Reserve for AUO test)
28	GND	Ground
29	NC	No Connection (Reserve for AUO test)
30	NC	No Connection (Reserve for AUO test)

Note1: Start from right side

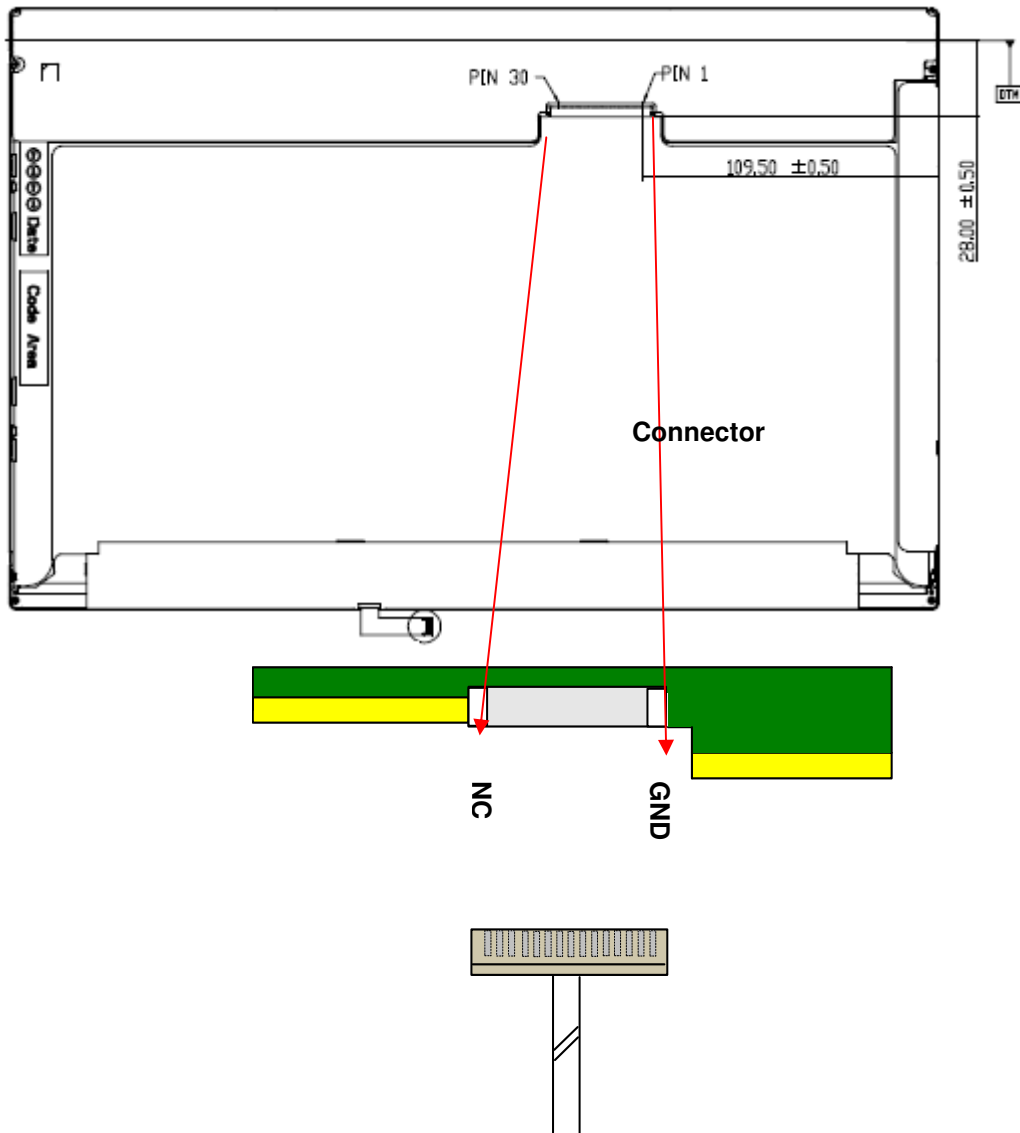

Note2: Input signals shall be low or High-impedance state when VDD is off.

internal circuit of LVDS inputs are as following.

The module uses a 100ohm resistor between positive and negative data lines of each receiver input

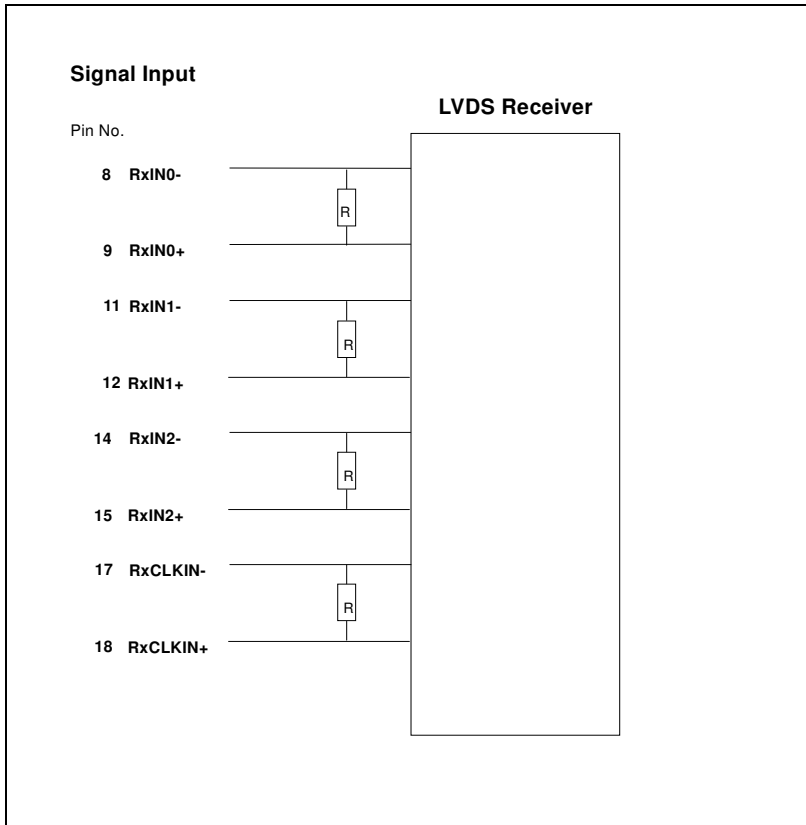

## 6.4 Interface Timing

### 6.4.1 Timing Characteristics

Basically, interface timings should match the 1280x800 /60Hz manufacturing guide line timing.

Parameter	Symbol	Min.	Typ.	Max.	Unit	
Frame Rate	-	-	60	-	Hz	
Clock frequency	$1/T_{Clock}$	-	71.11	72	MHz	
Vertical Section	Period	$T_V$	808	824	1023	$T_{Line}$
	Active	$T_{VD}$	800	800	800	
	Blanking	$T_{VB}$	8	24	223	
Horizontal Section	Period	$T_H$	1310	1438	2047	$T_{Clock}$
	Active	$T_{HD}$	1280	1280	1280	
	Blanking	$T_{HB}$	30	158	767	

Note : DE mode only

### 6.4.2 Timing diagram

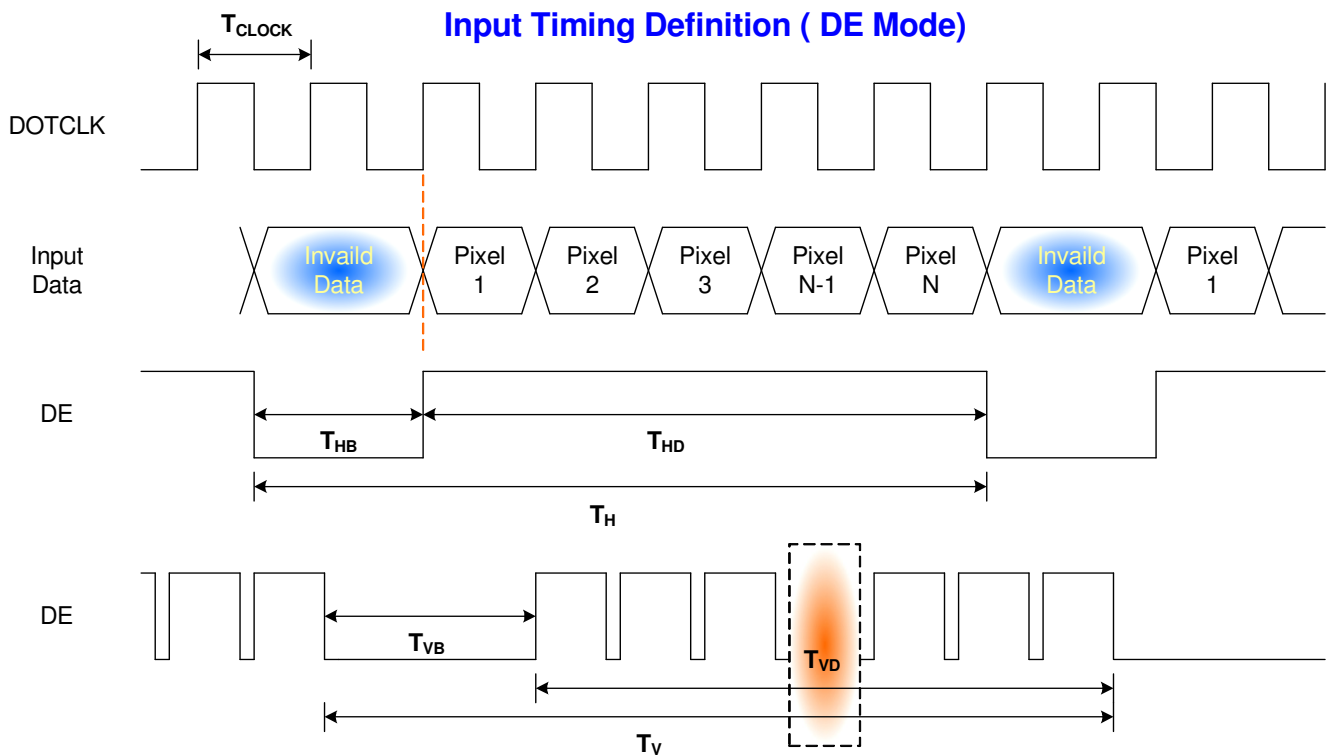

## 6.5 Power ON/OFF Sequence

VDD power and lamp on/off sequence is as follows. Interface signals are also shown in the chart. Signals from any system shall be Hi-Z state or low level when VDD is off.

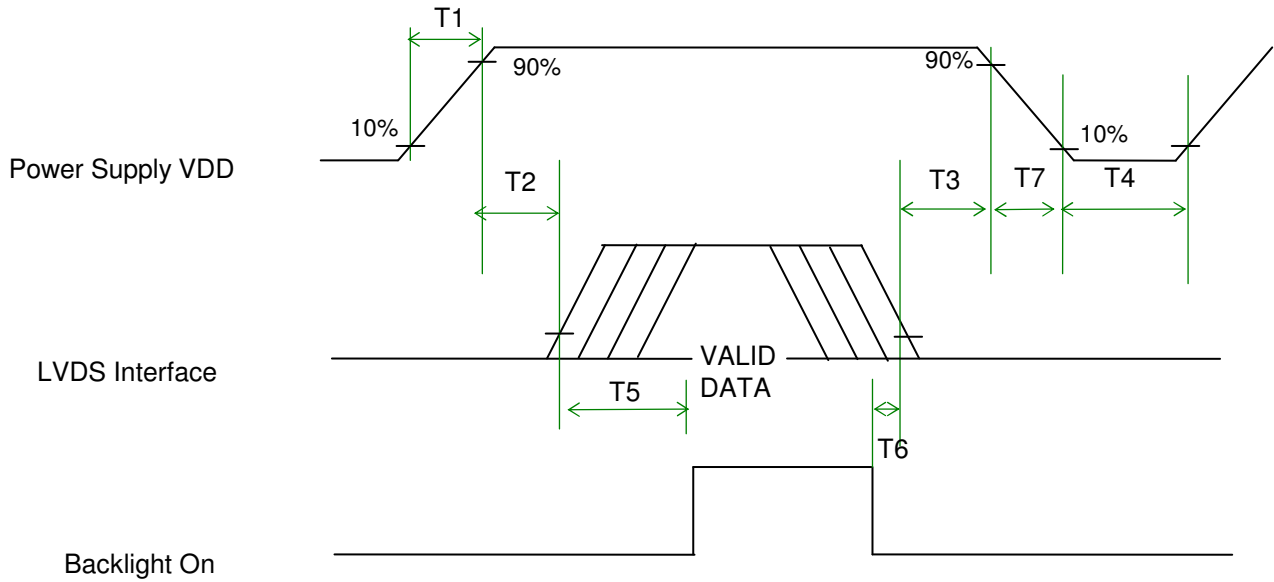

**Power Sequence Timing**

Parameter	Value			Units
	Min.	Typ.	Max.	
T1	0.5	-	10	ms
T2	0	-	50	
T3	0	-	50	
T4	400	-	-	
T5	200	-	-	
T6	200	-	-	
T7	0	-	10	

## 7. Connector Description

Physical interface is described as for the connector on module.

These connectors are capable of accommodating the following signals and will be following components.

### 7.1 TFT LCD Module

<b>Connector Name / Designation</b>	<b>For Signal Connector</b>
Manufacturer	JAE or compatible
Type / Part Number	FI-XB30SL-HF10 or compatible
Mating Housing/Part Number	FI-X30H or compatible

## 8. LED Driving Specification

### 8.1 Backlight connection

Physical interface is described as for the connector on module.

These connectors are capable of accommodating the following signals and will be following components.

Connector Name / Designation	For Signal Connector
Manufacturer	HRS or compatible
Type / Part Number	HRS FH33-12S-0.5SH(05) or compatible
Mating Housing/Part Number	HRS FH33-12S-0.5SH(05) or compatible

### 8.2 Pin Assignment

PIN#	Signal Name
1	LCD channel 1 cathode
2	LCD channel 2 cathode
3	LCD channel 3 cathode
4	LCD channel 4 cathode
5	LCD channel 5 cathode
6	LCD channel 6 cathode ( May be NC if channel<6)
7	LCD channel 7 cathode ( May be NC if channel<7)
8	LCD channel 8 cathode ( May be NC if channel<8)
9	NC
10	LED power bus ( LED Anode)
11	LED power bus ( LED Anode)
12	LED power bus ( LED Anode)





## 9. Vibration and Shock Test

### 9.1 Vibration Test

**Test Spec:**

- Test method: Non-Operation
- Acceleration: 1.5 G
- Frequency: 10 - 500Hz Random
- Sweep: 30 Minutes each Axis (X, Y, Z)

### 9.2 Shock Test Spec:

**Test Spec:**

- Test method: Non-Operation
- Acceleration: 220 G , Half sine wave
- Active time: 2 ms
- Pulse: X,Y,Z .one time for each side

## 10. Reliability

Items	Required Condition	Note
Temperature Humidity Bias	Ta= 40°C, 90%RH, 300h	
High Temperature Operation	Ta= 50°C, Dry, 300h	
Low Temperature Operation	Ta= 0°C, 300h	
High Temperature Storage	Ta= 60°C, 35%RH, 300h	
Low Temperature Storage	Ta= -20°C, 50%RH, 250h	
Thermal Shock Test	Ta=-20°C to 60°C, Duration at 30 min, 100 cycles	
ESD	Contact : ±8 KV Air : ±15 KV	Note 1

**Note1:** According to EN 61000-4-2 , ESD class B: Some performance degradation allowed. No data lost  
 . Self-recoverable. No hardware failures.

**Remark:** MTBF (Excluding the LED): 30,000 hours with a confidence level 90%



# Product Specification

AU OPTRONICS CORPORATION

## 11. Mechanical Characteristics

### 11.1 LCM Outline Dimension

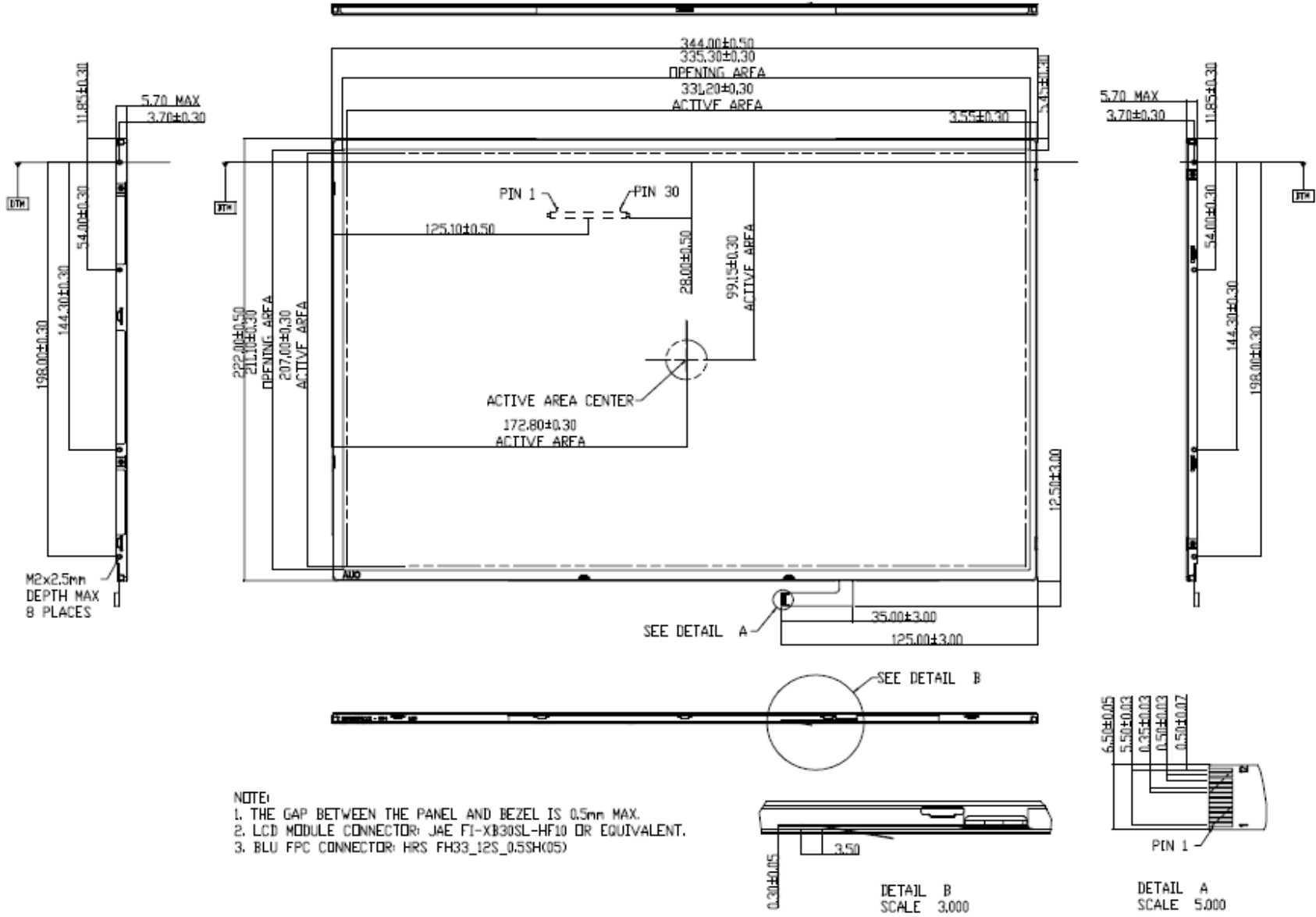

# Product Specification

AU OPTRONICS CORPORATION

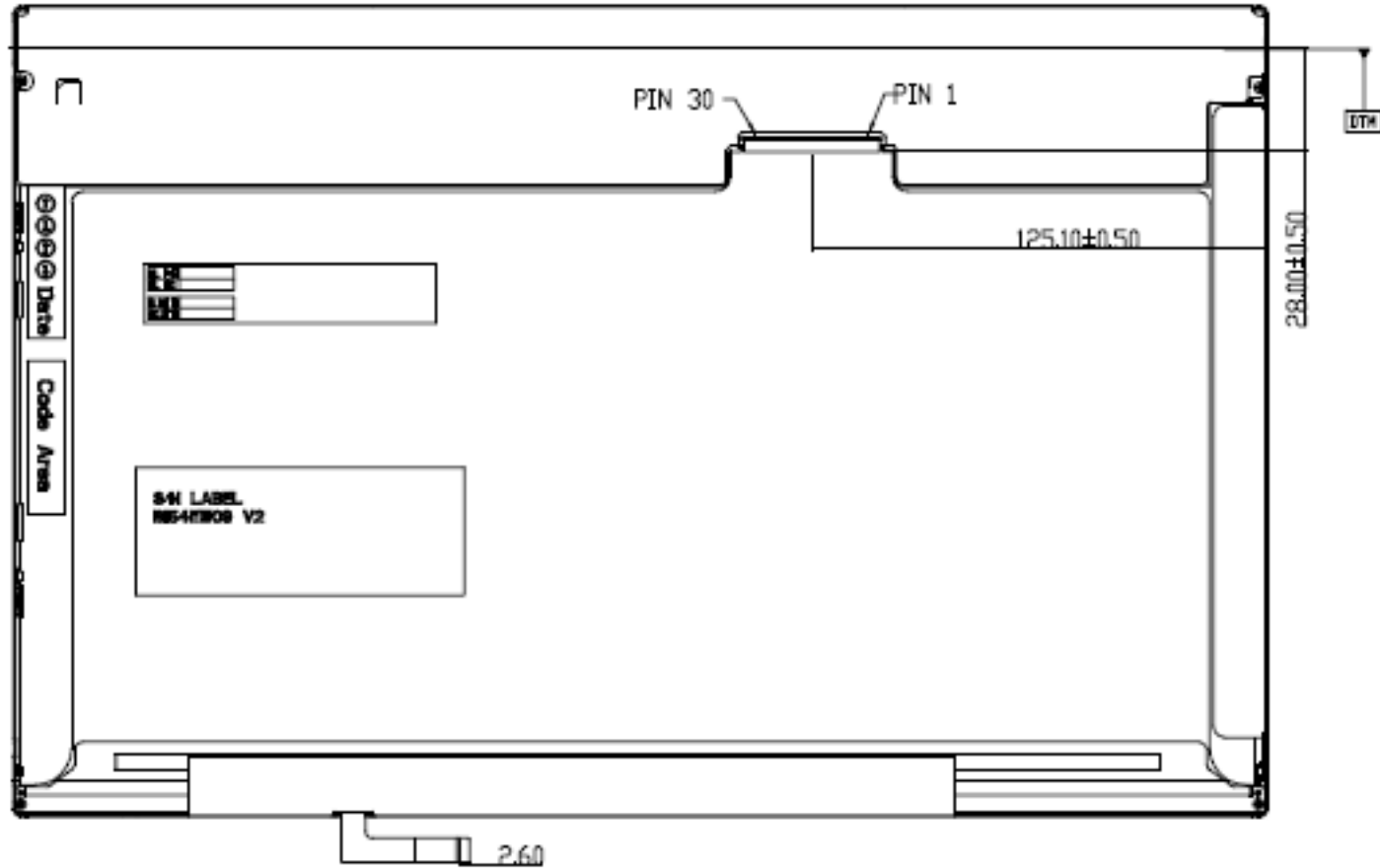

## 11.2 Screw Hole Depth and Center Position

Screw hole minimum depth, from side surface = 2.3 mm (See drawing)

Screw hole center location, from front surface =  $3.7 \pm 0.2$ mm (See drawing)

Screw Torque: Maximum 2.0 kgf-cm

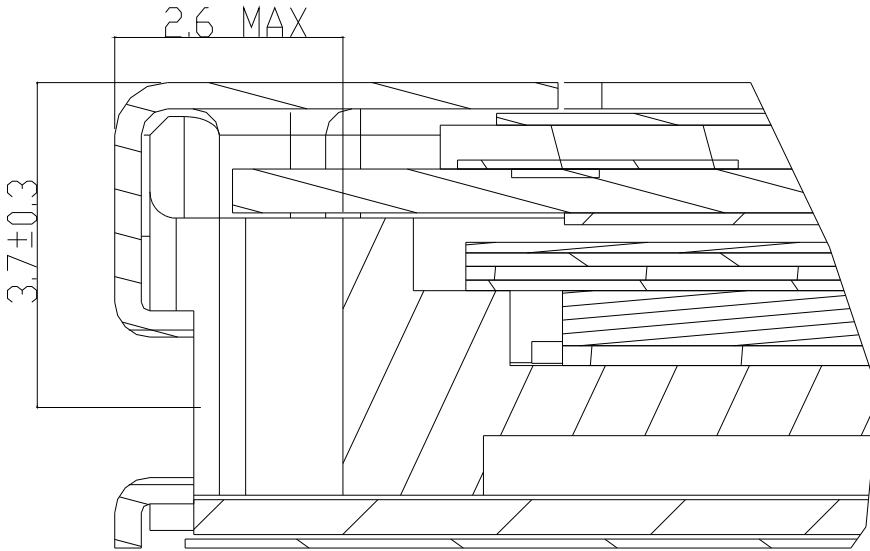

## 12. Shipping and Package

### 12.1 Shipping Label Format

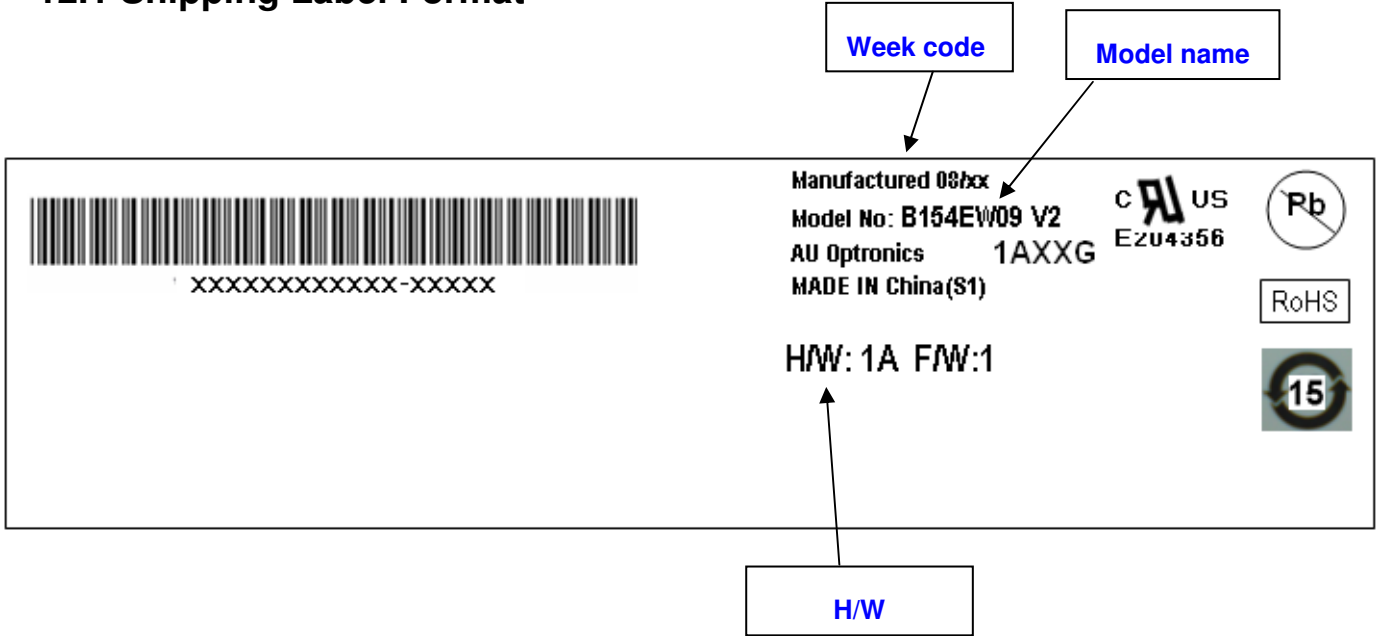

## 12.2 Carton package

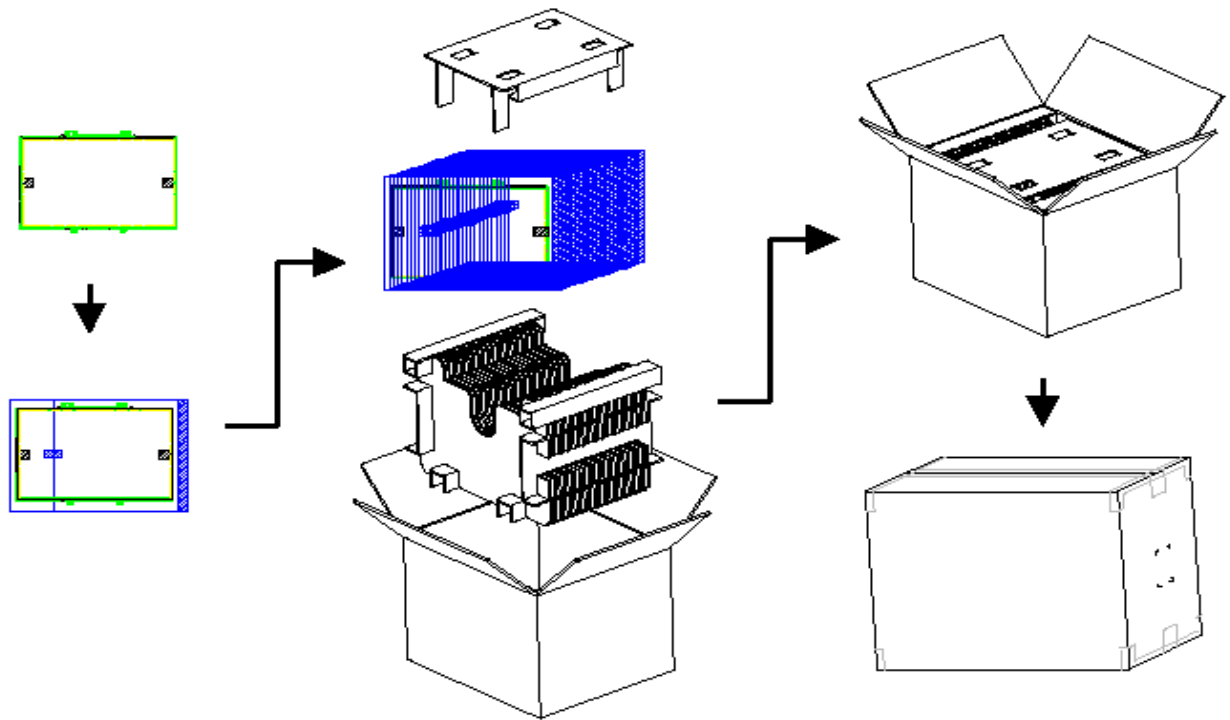

## 12.3 Shipping package of palletizing sequence

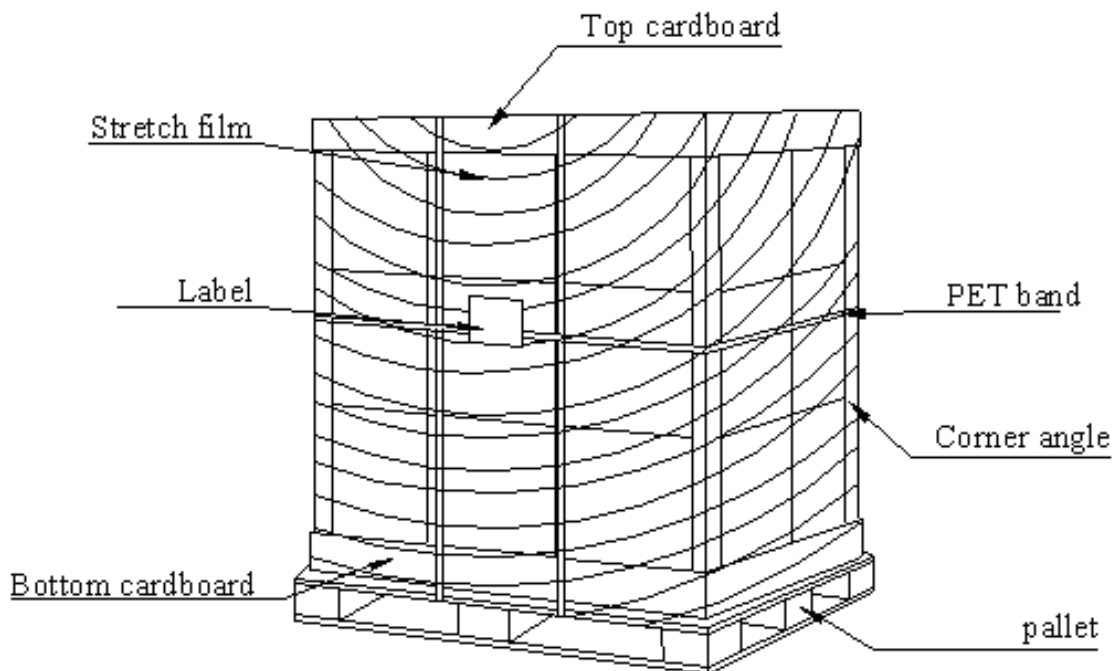



# Product Specification

AU OPTRONICS CORPORATION

## 13. Appendix: EDID description

Address	FUNCTION	B154EW09 V2	Value	Value	Note
HEX		HEX	BIN	DEC	
00	Header	00	00000000	0	
01		FF	11111111	255	
02		FF	11111111	255	
03		FF	11111111	255	
04		FF	11111111	255	
05		FF	11111111	255	
06		FF	11111111	255	
07		00	00000000	0	
08	EISA Manuf. Code LSB	06	00000110	6	
09	Compressed ASCII	AF	10101111	175	
0A	Product Code	74	01110100	116	
0B	hex, LSB first	92	10010010	146	
0C	32-bit ser #	00	00000000	0	
0D		00	00000000	0	
0E		00	00000000	0	
0F		00	00000000	0	
10	Week of manufacture	01	00000001	1	
11	Year of manufacture	12	00010010	18	
12	EDID Structure Ver.	01	00000001	1	
13	EDID revision #	03	00000011	3	
14	<b>Video input def.</b> ( <i>digital I/P, non-TMDS, CRGB</i> )	80	10000000	128	
15	<b>Max H image size</b> ( <i>rounded to cm</i> )	21	00100001	33	
16	<b>Max V image size</b> ( <i>rounded to cm</i> )	15	00010101	21	
17	<b>Display Gamma</b> ( <i>=(gamma*100)-100</i> )	78	01111000	120	
18	<b>Feature support</b> ( <i>no DPMS, Active OFF, RGB, tmg Blk#1</i> )	0A	00001010	10	
19	Red/green low bits ( <b>Lower 2:2:2:2 bits</b> )	10	00010000	16	
1A	Blue/white low bits ( <b>Lower 2:2:2:2 bits</b> )	B5	10110101	181	
1B	Red x ( <b>Upper 8 bits</b> )	97	10010111	151	
1C	Red y/ highER 8 bits	58	01011000	88	
1D	Green x	57	01010111	87	
1E	Green y	92	10010010	146	
1F	Blue x	26	00100110	38	
20	Blue y	1E	00011110	30	
21	White x	50	01010000	80	
22	White y	54	01010100	84	
23	Established timing 1	00	00000000	0	
24	Established timing 2	00	00000000	0	
25	Established timing 3	00	00000000	0	





# Product Specification

AU OPTRONICS CORPORATION

26	Standard timing #1	01	00000001	1	
27		01	00000001	1	
28	Standard timing #2	01	00000001	1	
29		01	00000001	1	
2A	Standard timing #3	01	00000001	1	
2B		01	00000001	1	
2C	Standard timing #4	01	00000001	1	
2D		01	00000001	1	
2E	Standard timing #5	01	00000001	1	
2F		01	00000001	1	
30	Standard timing #6	01	00000001	1	
31		01	00000001	1	
32	Standard timing #7	01	00000001	1	
33		01	00000001	1	
34	Standard timing #8	01	00000001	1	
35		01	00000001	1	
36	Pixel Clock/10000 LSB	C7	11000111	199	
37	Pixel Clock/10000 USB	1B	00011011	27	
38	Horz active <b>Lower 8bits</b>	00	00000000	0	
39	Horz blanking <b>Lower 8bits</b>	9E	10011110	158	
3A	HorzAct:HorzBlnk <b>Upper 4:4 bits</b>	50	01010000	80	
3B	Vertical Active <b>Lower 8bits</b>	20	00100000	32	
3C	Vertical Blanking <b>Lower 8bits</b>	18	00011000	24	
3D	Vert Act : Vertical Blanking <b>(upper 4:4 bit)</b>	30	00110000	48	
3E	HorzSync. Offset	30	00110000	48	
3F	HorzSync.Width	20	00100000	32	
40	VertSync.Offset : VertSync.Width	36	00110110	54	
41	Horz&Vert Sync Offset/Width <b>Upper 2bits</b>	00	00000000	0	
42	Horizontal Image Size <b>Lower 8bits</b>	4B	01001011	75	
43	Vertical Image Size <b>Lower 8bits</b>	CF	11001111	207	
44	Horizontal & Vertical Image Size <b>(upper 4:4 bits)</b>	10	00010000	16	
45	Horizontal Border <i>(zero for internal LCD)</i>	00	00000000	0	
46	Vertical Border <i>(zero for internal LCD)</i>	00	00000000	0	
47	Signal <i>(non-intr, norm, no stero, sep sync, neg pol)</i>	18	00011000	24	
48	Detailed timing/monitor	00	00000000	0	
49	descriptor #2	00	00000000	0	
4A		00	00000000	0	
4B		0F	00001111	15	
4C		00	00000000	0	
4D		00	00000000	0	
4E		00	00000000	0	
4F		00	00000000	0	
50		00	00000000	0	



# Product Specification

AU OPTRONICS CORPORATION

51		00	00000000	0	
52		00	00000000	0	
53		00	00000000	0	
54		00	00000000	0	
55		00	00000000	0	
56		00	00000000	0	
57		00	00000000	0	
58		00	00000000	0	
59		20	00100000	32	
5A	Detailed timing/monitor	00	00000000	0	
5B	descriptor #3	00	00000000	0	
5C		00	00000000	0	
5D		FE	11111110	254	
5E		00	00000000	0	
5F	Manufacture	41	01000001	65	A
60	Manufacture	55	01010101	85	U
61	Manufacture	4F	01001111	79	O
62		0A	00001010	10	
63		20	00100000	32	
64		00	00000000	0	
65		20	00100000	32	
66		20	00100000	32	
67		20	00100000	32	
68		20	00100000	32	
69		20	00100000	32	
6A		20	00100000	32	
6B		20	00100000	32	
6C	Detailed timing/monitor	00	00000000	0	
6D	descriptor #4	00	00000000	0	
6E		00	00000000	0	
6F		FE	11111110	254	
70		00	00000000	0	
71	Manufacture P/N	42	01000010	66	B
72	Manufacture P/N	31	00110001	49	1
73	Manufacture P/N	35	00110101	53	5
74	Manufacture P/N	34	00110100	52	4
75	Manufacture P/N	45	01000101	69	E
76	Manufacture P/N	57	01010111	87	W
77	Manufacture P/N	30	00110000	48	0
78	Manufacture P/N	39	00111001	57	9
79	Manufacture P/N	20	00100000	32	
7A	Manufacture P/N	56	01010110	86	V
7B	Manufacture P/N	32	00110010	50	2



# Product Specification

AU OPTRONICS CORPORATION

7C		20	00100000	32	
7D		0A	00001010	10	
7E	Extension Flag	00	00000000	0	
7F	Checksum	9A	10011010	154	
			SUM	6144	