

Features

- Diffused Junction
- Low Forward Voltage Drop
- High Current Capability
- High Reliability
- High Surge Current Capability
- High Case Dielectric Strength
- Ideal for Printed Circuit Boards

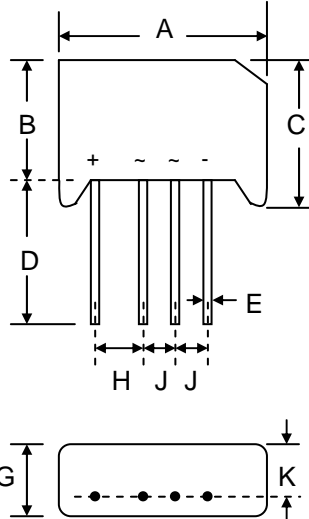

RS-5		
Dim	Min	Max
A	39.40	40.50
B	20.50	21.50
C	21.00	22.50
D	25.40	—
E	0.97 Ø	1.07 Ø
G	6.50	7.50
H	9.00	10.20
J	7.20	7.60
K	4.60	5.00
All Dimensions in mm		

Mechanical Data

- Case: RS-5, Molded Plastic
- Terminals: Plated Leads Solderable per MIL-STD-202, Method 208
- Polarity: As Marked on Body
- Weight: 9.8 grams (approx.)
- Mounting Position: Any
- Marking: Type Number
- **Lead Free: For RoHS / Lead Free Version, Add “-LF” Suffix to Part Number, See Page 4**

Maximum Ratings and Electrical Characteristics @ $T_A=25^\circ\text{C}$ unless otherwise specified

Single Phase, half wave, 60Hz, resistive or inductive load. For capacitive load, derate current by 20%.

Characteristic	Symbol	B40C 3700/2200	B80C 3700/2200	B125C 3700/2200	B250C 3700/2200	B380C 3700/2200	B500C 3700/2200	Unit
Peak Repetitive Reverse Voltage	V_{RRM}							V
Working Peak Reverse Voltage	V_{RWM}	100	200	300	600	900	1000	V
DC Blocking Voltage	V_R							V
Recommend Input Voltage	V_{RMS}	40	80	125	250	380	500	V
Average Rectified Output Current @ $T_A = 45^\circ\text{C}$ (Note 1)	I_O	3.7						A
Non-Repetitive Peak Forward Surge Current 8.3ms Single half sine-wave superimposed on rated load (JEDEC Method)	I_{FSM}	150						A
Repetitive Peak Forward Surge Current	I_{FRM}	20						A
Forward Voltage per leg @ $I_F = 3.0\text{A}$	V_{FM}	1.0						V
Peak Reverse Current @ $T_C = 25^\circ\text{C}$ At Rated DC Blocking Voltage @ $T_C = 125^\circ\text{C}$	I_{RM}	10 500						μA
Rating for Fusing (Note 2)	I_t^2	110						A^2s
Thermal Resistance per leg (Note 1)	R_{JA}	3.0						$^\circ\text{C}/\text{W}$
Operating and Storage Temperature Range	T_J, T_{STG}	-55 to +150						$^\circ\text{C}$

Note: 1. Mounted on 76 x 76 x 2.8mm thick Al. heatsink.
2. Non-repetitive for $t > 1\text{ms}$ and $< 8.3\text{ms}$.

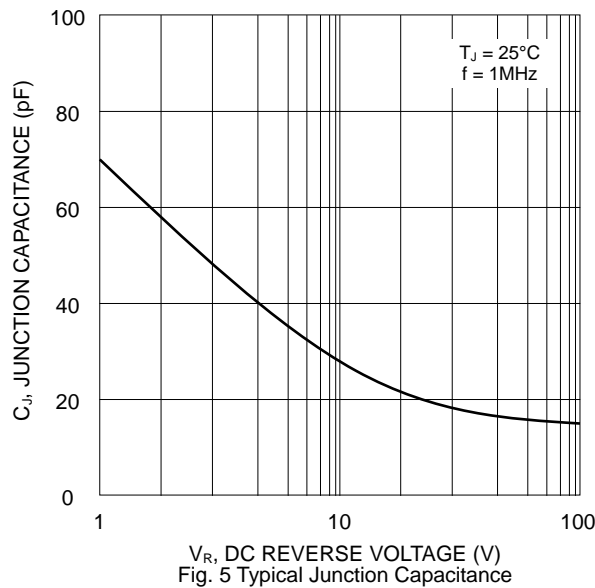
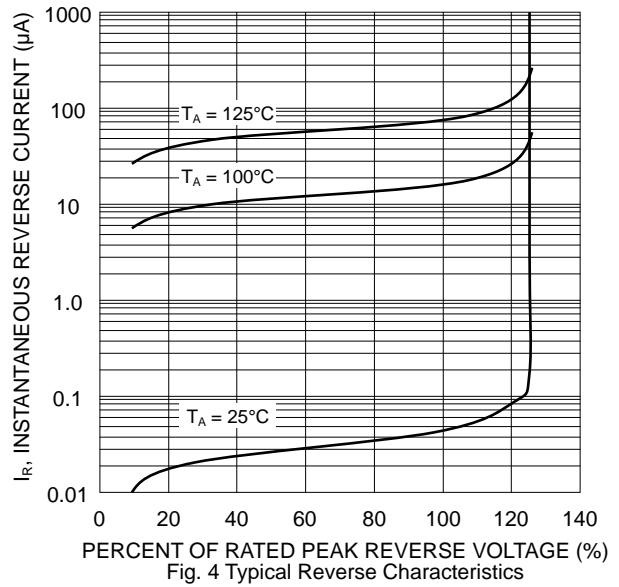
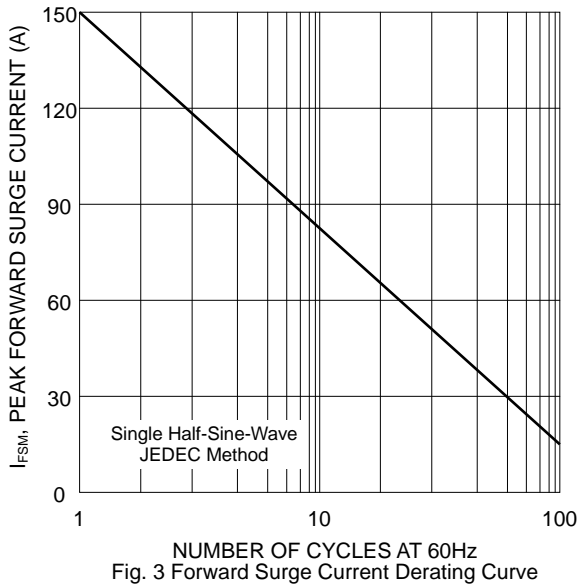
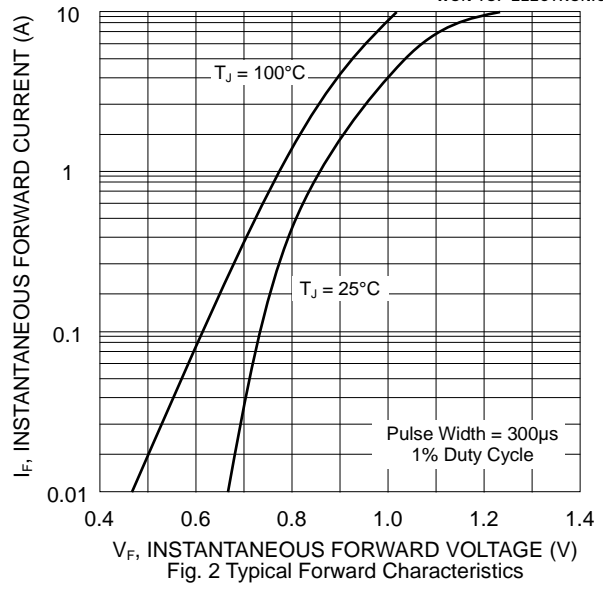
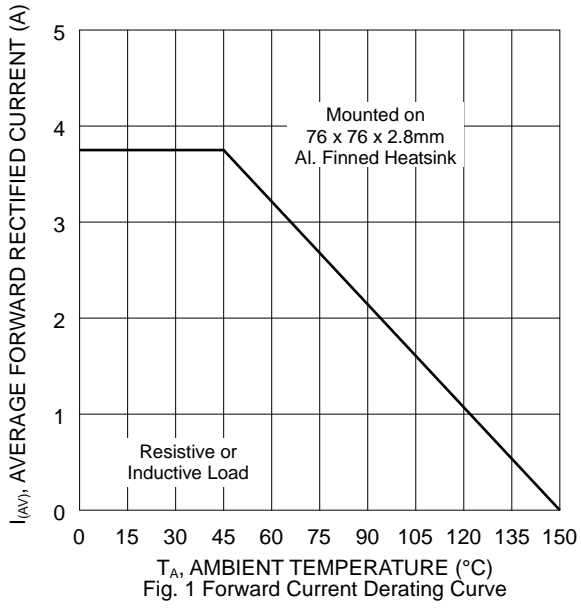

MARKING INFORMATION

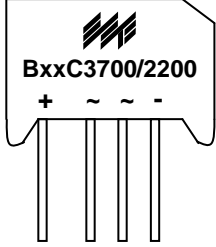

BxxC3700/2200 = Device Number
xx = 40, 80, 125, 250, 380 or 500
Polarity = As Marked on Body

PACKAGING INFORMATION

BULK

Inner Box Size L x W x H (mm)	Quantity (PCS)	Carton Size L x W x H (mm)	Quantity (PCS)	Approx. Gross Weight (KG)
230 x 230 x 56	200	500 x 255 x 275	2,000	23.0

Note: 1. Paper box, white or brown color.

ORDERING INFORMATION

Product No.	Package Type	Shipping Quantity
B40C3700/2200	SIL Bridge	200 Units/Box
B80C3700/2200	SIL Bridge	200 Units/Box
B125C3700/2200	SIL Bridge	200 Units/Box
B250C3700/2200	SIL Bridge	200 Units/Box
B380C3700/2200	SIL Bridge	200 Units/Box
B500C3700/2200	SIL Bridge	200 Units/Box

1. Shipping quantity given is for minimum packing quantity only. For minimum order quantity, please consult the Sales Department.
2. **To order RoHS / Lead Free version (with Lead Free finish), add "-LF" suffix to part number above. For example, B40C3700/2200-LF.**

WON-TOP ELECTRONICS and  are registered trademarks of Won-Top Electronics Co., Ltd (WTE). WTE has checked all information carefully and believes it to be correct and accurate. However, WTE cannot assume any responsibility for inaccuracies. Furthermore, this information does not give the purchaser of semiconductor devices any license under patent rights to manufacturer. WTE reserves the right to change any or all information herein without further notice.

WARNING: DO NOT USE IN LIFE SUPPORT EQUIPMENT. WTE power semiconductor products are not authorized for use as critical components in life support devices or systems without the express written approval.

Won-Top Electronics Co., Ltd.
No. 44 Yu Kang North 3rd Road,
Chine Chen Dist., Kaohsiung 806, Taiwan
Phone: 886-7-822-5408 or 886-7-822-5410
Fax: 886-7-822-5417
Email: sales@wontop.com
Internet: <http://www.wontop.com>

We power your everyday.