

SCHOTTKY BARRIER RECTIFIERS

B220A--B260A

FEATURES

- For surface mounted applications
- Low profile package
- Built-in strain relief
- Metal silicon junction, majority carrier conduction
- High surge capability
- Low power loss, high efficiency
- For use in low voltage high frequency inverters, free wheeling and polarity protection applications
- Guardring for overvoltage protection
- Plastic package has Underwriters Laboratory Flammability Classification 94V-0
- High temperature soldering guaranteed:250°C/10 seconds at terminals



Lead-free

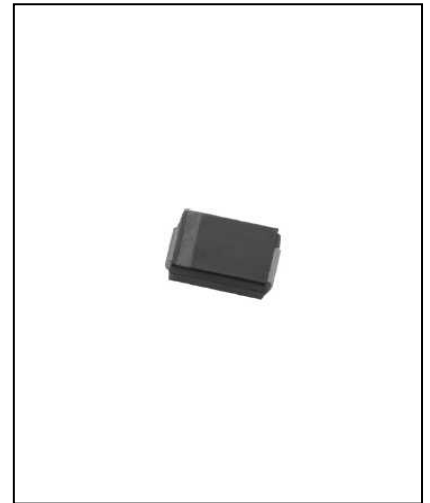

MECHANICAL DATA

- Case: JEDEC SMA, molded plastic over passivated chip
- Terminals: Solder plated, solderable per MIL-STD-750, Method 2026
- Polarity: Color band denotes cathode end
- Weight: 0.002 ounces, 0.064 gram

MAXIMUM RATINGS AND ELECTRICAL CHARACTERISTICS

Ratings at 25°C ambient temperature unless otherwise specified

		B220A	B230A	B240A	B250A	B260A	UNITS
Maximum repetitive peak reverse voltage	V_{RRM}	20	30	40	50	60	V
Maximum RMS voltage	V_{RWS}	14	21	28	35	42	V
Maximum DC blocking voltage	V_{DC}	20	30	40	45	50	V
Maximum average for word rectified current at T_L (SEE FIG.1)	$I_{F(AV)}$	2.0					A
Peak forward surge current 8.3ms single half-sine-wave	I_{FSM}	50.0					A
Maximum instantaneous forward voltage at 2.0A(NOTE1)	V_F	0.50			0.70		V
Maximum DC reverse current @ $T_A=25^\circ C$ at rated DC blockjng voltage @ $T_A=100^\circ C$ (NOTE1)	I_R	0.5 20.0					mA
Typical junction capacitance (NOTE2)	$R_{\theta JL}$	15.0					°C/W
Operating temperature range	T_J	-55--- +125					°C
Storage temperature range	T_{STG}	-55--- +125					°C

NOTE: 1.Pulse test:300 μ S pulse width,1%duty cycle

2. P.C.B. mounted with 0.55"X0.55"(14.0X14.0mm2) copper pad areas

SCHOTTKY BARRIER RECTIFIERS

B220A--B260A

PACKAGE OUTLINE DIMENSIONS

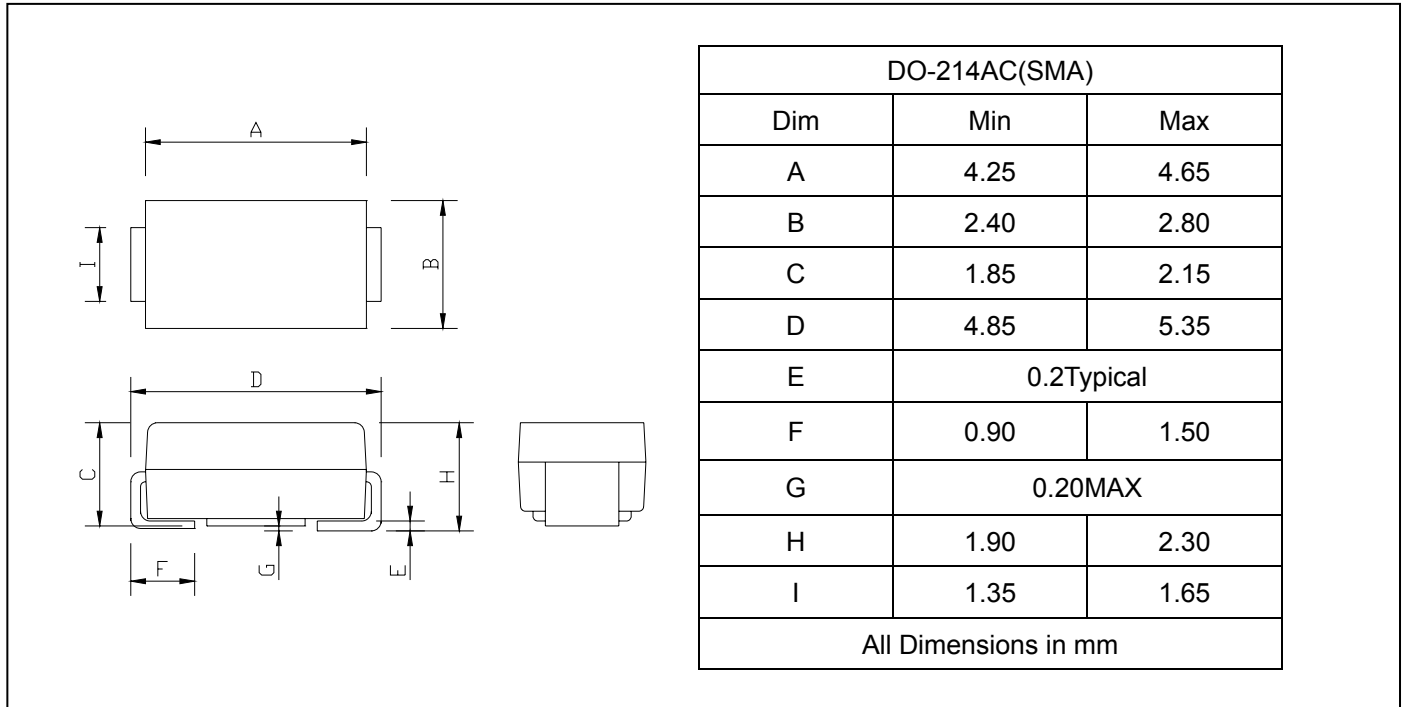

SOLDERING FOOTPRINT

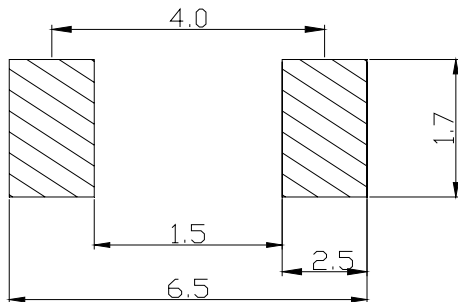

Unit : mm

PACKAGE INFORMATION

Device	Package	Shipping
B220A--B260A	DO-214AC(SMA)	5000/Tape&Reel

SCHOTTKY BARRIER RECTIFIERS

B220A--B260A

FIG.1 – FORWARD DERATING CURVE

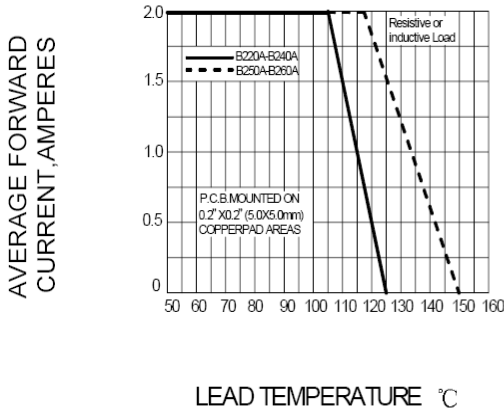

FIG.2- PEAK FORWARD SURGE CURRENT

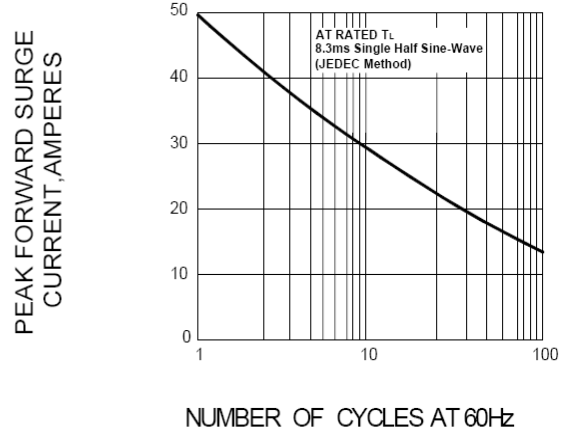

FIG.3 – TYPICAL FORWARD CHARACTERISTICS

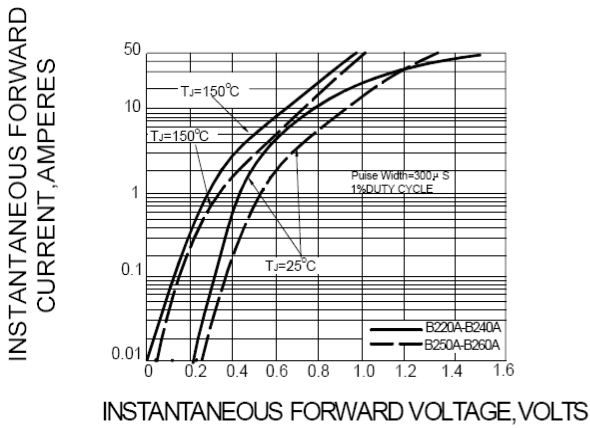

FIG.4 – TYPICAL REVERSE CHARACTERISTICS

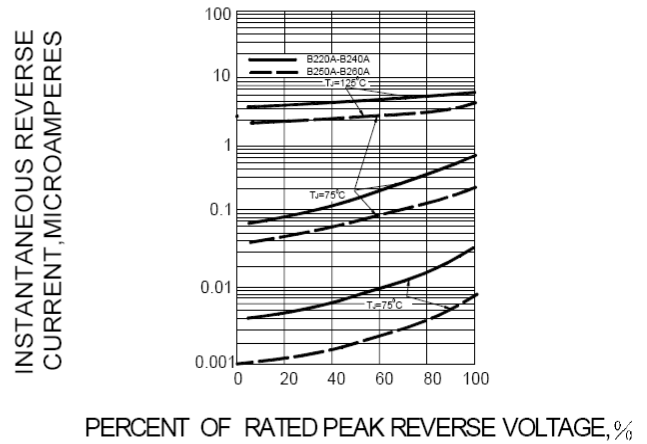

FIG.5-TYPICAL JUNCTION CAPACITANCE

