

SIKOREL®

Applications

- For automotive applications with high EMV requirements

Features

- Very high ripple current capability
- Very low ESR, down to -55 °C
- High vibration resistance
- High reliability up to $140\text{ °C} / 1000\text{ h}$
- Shelf life up to 15 years

Construction

- Charge-discharge proof, polar
- Aluminum case with insulating sleeve
- Negative pole connected to case

Terminals

- Axial leads, welded to ensure perfect electrical contact
- Also available with soldering stars

...DataSheet4U.com

Taping and packing

- Axial-lead capacitors will be delivered in pallet package.
Capacitors with $d \times l \leq 16 \times 30\text{ mm}$ are also available taped on reel.
- Solder-star capacitors are packed in cardboard.

For details on taping and packing, refer to page 342.

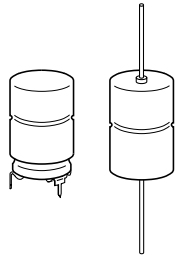

KAL0573-K

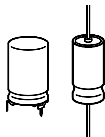
B41694 / B41794
Low ESR – Up to 140 °C
Specifications and characteristics in brief

Rated voltage U_R	25 and 40 VDC				
Surge voltage U_S	$1,15 \cdot U_R$				
Rated capacitance C_R	330 ... 1 500 μF				
Capacitance tolerance	– 10/+ 30 % \triangleq Q				
Leakage current I_L (5 min, 20 °C)	$I_L \leq 0,006 \mu\text{A} \cdot \left(\frac{C_R}{\mu\text{F}} \cdot \frac{U_R}{\text{V}} \right) + 4 \mu\text{A}$				
Self-inductance $ESL^{1)}$	Diameter d	12 mm	14 mm	16 mm	18 mm
	Length / Terminal	Approx. ESL (nH)			
	25 mm axial / solder star	— / —	22 / 6	26 / 7	— / —
	30 mm axial / solder star	21 / 6	24 / 7	29 / 8	34 / 10
	39 mm axial / solder star	— / —	— / —	33 / 9	38 / 11
Useful life 140 °C; U_R ; I_{-R} 125 °C; U_R ; I_{-R} 85 °C; U_R ; I_{-max} 40 °C; U_R ; $2,1 \cdot I_{-R}$	> 1 000 h > 3 000 h > 8 000 h > 200 000 h	Requirements: $\Delta C/C \leq \pm 30\%$ of initial value $ESR \leq 3$ times initial specified limit $I_L \leq$ initial specified limit Failure percentage: $\leq 0,5\%$ Failure rate: ≤ 10 fit ($\leq 10 \cdot 10^{-9}/\text{h}$) (for definition “fit”, refer to chapter “Quality”, page 62)			
Voltage endurance test 125 °C; U_R	2 000 h	Post test requirements: $\Delta C/C \leq \pm 10\%$ of initial value $ESR \leq 1,3$ % initial specified limit $I_L \leq$ initial specified limit			
Vibration resistance	To IEC 60068–2–6, test Fc: displacement amplitude 1,5 mm, at 10 Hz to 2 kHz, acceleration max. 20 g, duration 3×2 h				
IEC climatic category	To IEC 60068–1: 55/125/56 (– 55 °C/+ 125 °C/56 days damp heat test)				
Detail specification	Similar to CECC 30301-802				
Sectional specification	IEC 60384–4				

1) If optimum circuit design is used, the values are lower by 30 %.

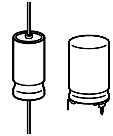

Dimensional drawings

Axial-lead capacitors

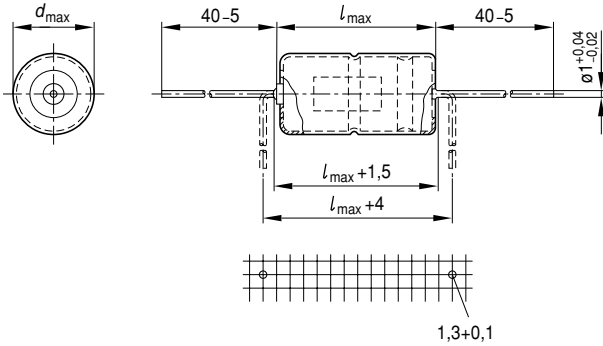

KAL0524-S

Dimensions, weights and packing units

$d \times l$ mm	$d_{\max} \times l_{\max}$ mm	Approx. weight g	Packing units (pieces)	
			Pallet	Reel
12 × 30	12,5 × 30,5	5,1	288	450
14 × 25	14,5 × 25,5	5,7	200	350
16 × 30	16,5 × 30,5	8,9	180	250
16 × 39	16,5 × 40	11,7	180	—
18 × 30	18,5 × 30,5	11,1	160	—
18 × 39	18,5 × 40	14,7	160	—

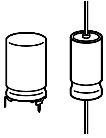

B41694 / B41794

Low ESR – Up to 140 °C

Soldering star capacitors

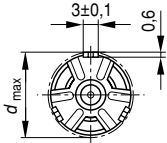

Mounting holes
d = 12 mm ... 14 mm

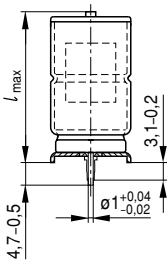
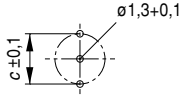

Mounting holes
d = 16 mm ... 18 mm

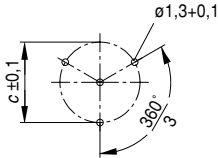

Soldering star is connected to the negative pole

KAL0525-1-E

The PC-board hole arrangement specified above is based on circular arcs.

If, however, the mounting holes have to be matched to a standard drilling raster, a spacing of 1,27 mm ($1/20''$) has proved to be sufficiently accurate if the following arrangements are used:

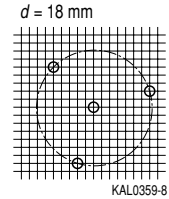
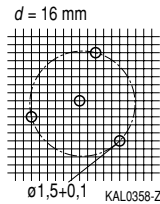
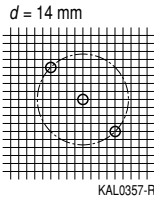
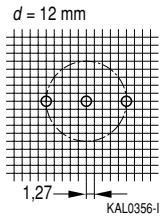

Dimensions, weights and packing units

d × l mm	d _{max} × l _{max} mm	c ± 0,1 mm	Approx. weight g	Packing units pieces
12 × 30	13,5 × 32	12,5	5,4	480
14 × 25	15,5 × 27	14,5	6,1	480
16 × 30	17,5 × 32	16,5	9,4	300
16 × 39	17,5 × 41,5	16,5	12,2	200
18 × 30	19,5 × 32	18,5	11,8	300
18 × 39	19,5 × 41,5	18,5	15,4	200

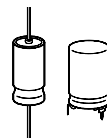
Overview of available types

U_R (VDC)	25	40
C_R (μ F)	Case dimensions $d \times l$ (mm)	
330		12 \times 30
470	14 \times 25	
1 000	16 \times 30	18 \times 30
1 500	16 \times 39	18 \times 39

Case dimensions and ordering codes

U_R	C_R	Case dim. $d \times l$ mm	Ordering code Axial pallet package	Axial reel	Soldering star
25 VDC	470	14 \times 25	B41694A5477Q007	B41694A5477Q009	B41794A5477Q000
	1 000	16 \times 30	B41694A5108Q007	B41694A5108Q009	B41794A5108Q000
	1 500	16 \times 39	B41694A5158Q007		B41794A5158Q000
40	330	12 \times 30	B41694A7337Q007	B41694A7337Q009	B41794A7337Q000
	1 000	18 \times 30	B41694A7108Q007		B41794A7108Q000
	1 500	18 \times 39	B41694A7158Q007		B41794A7158Q000

Technical data

C_R	ESR_{typ}	ESR_{max}	ESR_{max}	ESR_{max}	Z_{max}	$I_{\sim max}$	$I_{\sim max}$	$I_{\sim R}$
100 Hz	100 Hz	100 Hz	100 Hz	10 kHz	100 kHz	10 kHz	10 kHz	10 kHz
20 °C	20 °C	20 °C	-40 °C	20 °C	20 °C	40 °C	85 °C	125 °C
μ F	m Ω	m Ω	Ω	m Ω	m Ω	A	A	A
25 VDC								
470	110	170	0,9	70	65	5,90	5,15	2,25
1 000	55	90	0,5	40	38	8,20	7,15	3,15
1 500	40	60	0,4	28	26	11,20	9,80	4,30
40 VDC								
330	130	210	0,9	70	67	6,30	5,45	2,40
1 000	50	85	0,4	35	33	8,50	7,40	3,25
1 500	35	60	0,3	25	24	11,50	10,00	4,45

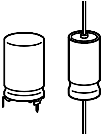

B41694 / B41794

Low ESR – Up to 140 °C

Useful life

depending on ambient temperature T_A under ripple current operating conditions at $U_R^{1)}$

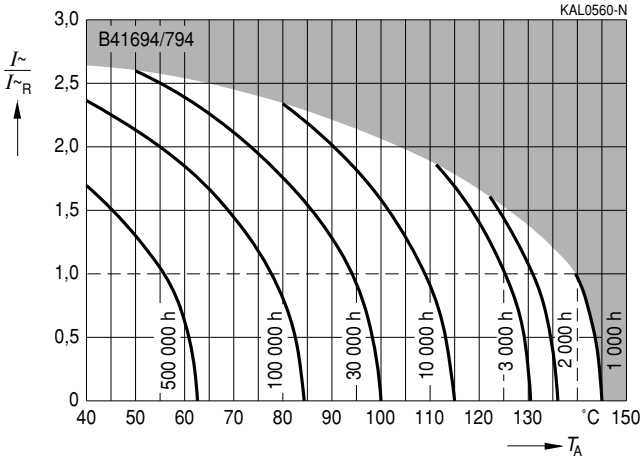

Useful life

depending on case temperature T_C under ripple current operating conditions at $U_R^{1)}$

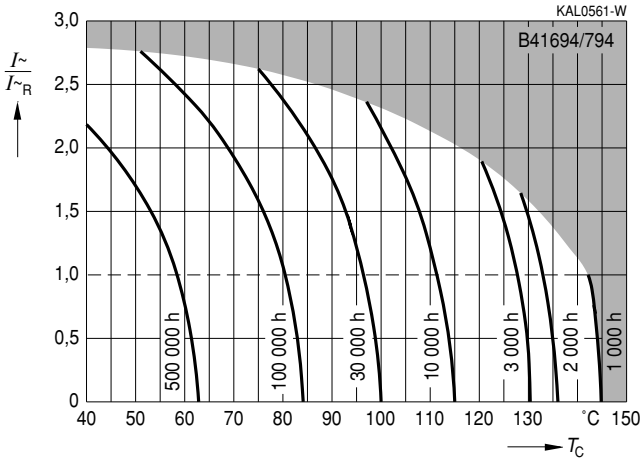

1) Refer to page 40 for an explanation on how to interpret the useful life graphs.

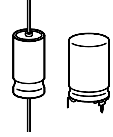

Frequency factor of permissible ripple current I_{\sim} versus frequency f

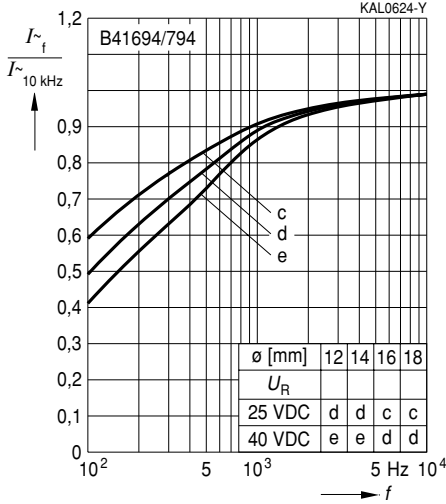

Frequency characteristics of ESR at different temperatures
Typical behavior

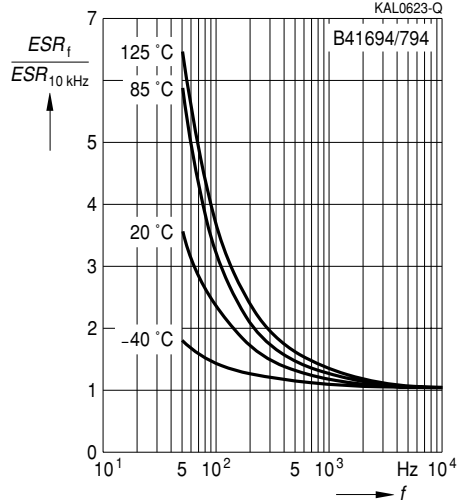

Equivalent series resistance ESR versus frequency at different temperatures
Typical behavior for 1 000 μ F/40 V

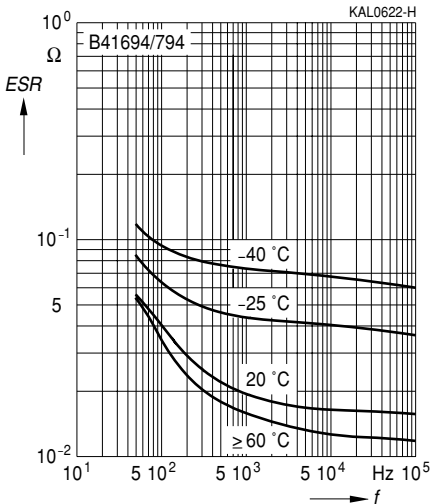

Impedance Z versus frequency f at different temperatures
Typical behavior for 1 000 μ F/40 V

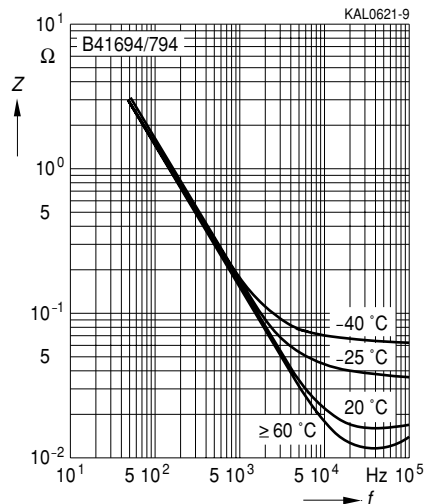

Herausgegeben von EPCOS AG

Unternehmenskommunikation, Postfach 80 17 09, 81617 München, DEUTSCHLAND

☎ ++49 89 636 09, FAX (0 89) 636-2 26 89

© EPCOS AG 2002. Vervielfältigung, Veröffentlichung, Verbreitung und Verwertung dieser Broschüre und ihres Inhalts ohne ausdrückliche Genehmigung der EPCOS AG nicht gestattet.

Bestellungen unterliegen den vom ZVEI empfohlenen Allgemeinen Lieferbedingungen für Erzeugnisse und Leistungen der Elektroindustrie, soweit nichts anderes vereinbart wird.

Diese Broschüre ersetzt die vorige Ausgabe.

Fragen über Technik, Preise und Liefermöglichkeiten richten Sie bitte an den Ihnen nächstgelegenen Vertrieb der EPCOS AG oder an unsere Vertriebsgesellschaften im Ausland. Bauelemente können aufgrund technischer Erfordernisse Gefahrstoffe enthalten. Auskünfte darüber bitten wir unter Angabe des betreffenden Typs ebenfalls über die zuständige Vertriebsgesellschaft einzuholen.

Published by EPCOS AG

Corporate Communications, P.O. Box 80 17 09, 81617 Munich, GERMANY

☎ ++49 89 636 09, FAX (0 89) 636-2 26 89

© EPCOS AG 2002. Reproduction, publication and dissemination of this brochure and the information contained therein without EPCOS' prior express consent is prohibited.

Purchase orders are subject to the General Conditions for the Supply of Products and Services of the Electrical and Electronics Industry recommended by the ZVEI (German Electrical and Electronic Manufacturers' Association), unless otherwise agreed.

This brochure replaces the previous edition.

For questions on technology, prices and delivery please contact the Sales Offices of EPCOS AG or the international Representatives.

Due to technical requirements components may contain dangerous substances. For information on the type in question please also contact one of our Sales Offices.