

## General-purpose grade capacitors

### Applications

- Switch-mode power supplies in industrial and entertainment electronics

### Features

- High ripple current capability
- Different case sizes available for each capacitance value

### Construction

- Charge-discharge proof, polar
- Aluminum case, fully insulated
- Snap-in solder pins to hold component in place on PC-board
- Minus pole marking on case surface
- Minus pole not insulated from case
- Overload protection (safety vent)

### Terminals

- Standard version with 2 terminals  
2 lengths available: 6,3 and 4,5 mm
- 3 terminals: length 4,5 mm  
(terminal arrangement ensures correct insertion)

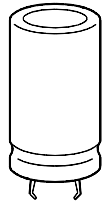

KAL0274-A

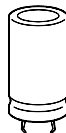
**Specifications and characteristics in brief**

	B41303	B43303 (not for new design)
Rated voltage $U_R$	10 ... 100 VDC	200 ... 500 VDC
Surge voltage $U_S$	$1,15 \cdot U_R$	$1,15 \cdot U_R$ (for $U_R \leq 250$ VDC) $1,10 \cdot U_R$ (for $U_R \geq 385$ VDC)
Rated capacitance $C_R$	680 ... 47 000 $\mu$ F	22 ... 1 500 $\mu$ F
Capacitance tolerance	$\pm 20 \% \triangleq M$	$\pm 20 \% \triangleq M$
Leakage current $I_L$ (5 min, 20 °C)	$I_L \leq 0,3 \mu\text{A} \cdot \left( \frac{C_R}{\mu\text{F}} \cdot \frac{U_R}{\text{V}} \right)^{0,7} + 4 \mu\text{A}$	
Self-inductance $ESL$	Approx. 20 nH	
Useful life 85 °C, $U_R$ ; $I_{-R}$ 40 °C, $U_R$ ; $1,15 \cdot I_{-R}$	> 2 000 h > 100 000 h	> 2 000 h > 100 000 h
Requirements:	$\Delta C/C \leq \pm 45 \%$ of initial value $ESR \leq 3$ times initial spec. limit $I_L \leq$ initial specified limit Failure percentage: $\leq 1 \%$ Failure rate: $\leq 100$ fit ( $\leq 100 \cdot 10^{-9}/\text{h}$ ) (for definiton "fit", refer to chapter "Quality", page 62)	$\Delta C/C \leq \pm 30 \%$ of initial value $ESR \leq 3$ times initial spec. limit $I_L \leq$ initial specified limit
Voltage endurance test 85 °C; $U_R$	2 000 h	2 000 h
Post test requirements:	$\Delta C/C \leq \pm 15 \%$ of initial value $ESR \leq 1,3$ times initial spec. limit $I_L \leq$ initial specified limit	$\Delta C/C \leq \pm 10 \%$ of initial value $ESR \leq 1,3$ times initial spec. limit $I_L \leq$ initial specified limit
Vibration resistance	To IEC 60068-2-6, test Fc: displacement amplitude 0,35 mm, frequency range 10 ... 55 Hz, acceleration max. 5 g, duration $3 \times 2$ h	
IEC climatic category	To IEC 60068-1: 40/085/56 (– 40 °C/+ 85 °C/56 days damp heat test)	25/085/56 (– 25 °C/+ 85 °C/56 days damp heat test)
Detail specification	Similar to CECC 30301-806	
Sectional specification	IEC 60384-4	

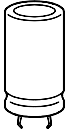

B41303 / B43303

Standard – 85 °C

Dimensional drawings

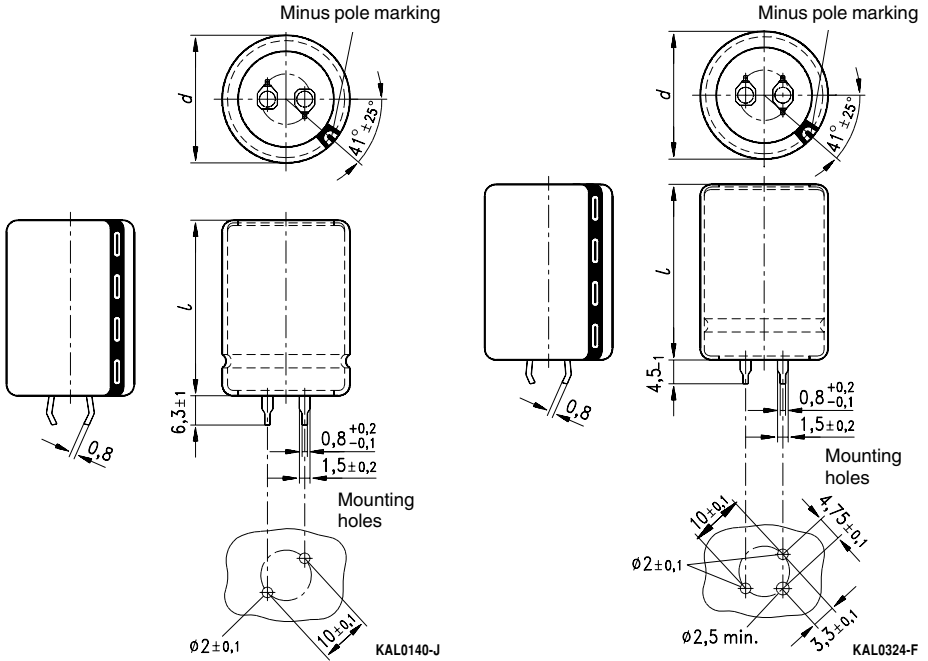

Snap-in terminals, standard (length  $6,3 \pm 1$  mm). Also available in a shorter version with a length of  $4,5 - 1$  mm. For packing mode and ordering example see next page.

Snap-in capacitors are also available with 3 terminals (length  $4,5 - 1$  mm). For packing mode and ordering example see next page.

Dimensions (mm)		Approx. weight (g)	Packing units (pieces)
$d + 1$	$l \pm 2$		
22	25	9	160
22	30	12	160
22	35	15	160
22	40	18	160
22	45	20	160
25	25	13	130
25	30	17	130
25	35	19	130
25	40	22	130
25	45	25	130

Dimensions (mm)		Approx. weight (g)	Packing units (pieces)
$d + 1$	$l \pm 2$		
30	20	14	80
30	25	17	80
30	30	23	80
30	35	29	80
30	40	36	80
30	45	41	80
30	50	46	80
35	20	19	60
35	40	44	60
35	45	52	60
35	50	59	60
35	55	66	60

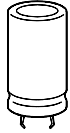
**Packing of snap-in capacitors**

For ecological reasons the packing is pure cardboard. Components can be withdrawn (in full or in part) in the correct position for insertion.

**Ordering codes**

Snap-in terminals Version	Identification in 3rd block of ordering code
Standard terminals (6,3 ± 1) mm	M000
Short terminals (4,5 –1) mm	M007
3 terminals (4,5 –1) mm	M002

Ordering example:

B41303A3109M007 } snap-in capacitor with short terminals  
 B41303A3109M002 } snap-in capacitor with 3 terminals

**Overview of available types**
**Type B41303**

$U_R$ (VDC)	10	16	25	40	63	100
$C_R$ ( $\mu$ F)	Case dimensions $d \times l$ (mm)					
680						22 × 30 25 × 25
1 000						22 × 35 25 × 30
1 500					22 × 30 25 × 25	25 × 35 30 × 30
2 200					22 × 35 25 × 30	30 × 35
3 300				22 × 30 25 × 25	25 × 35 30 × 30	30 × 45
4 700			22 × 30 25 × 25	22 × 35 25 × 30	30 × 35	
6 800		22 × 30 25 × 25	22 × 35 25 × 30	25 × 40 30 × 30	30 × 45	
10 000	22 × 30 25 × 25	22 × 35 25 × 30	25 × 35 30 × 30	30 × 35		
15 000	22 × 35 25 × 30	25 × 40 30 × 30	30 × 35	30 × 50		
22 000	25 × 40 30 × 30	30 × 35	30 × 45			
33 000	30 × 35	30 × 45				
47 000	30 × 45					

The capacitance and voltage ratings listed above are available in different cases upon request. Other voltage and capacitance ratings are also available upon request.

**Overview of available types**
**Type B43303 (not for new design)**

$U_R$ (VDC)	200	250	385	400	450	500
$C_R$ ( $\mu$ F)	Case dimensions $d \times l$ (mm)					
22						22 × 25
33						22 × 30
47						22 × 40
68			22 × 25	22 × 30	22 × 35	25 × 40
100			22 × 30 25 × 25	22 × 35 25 × 30	22 × 40	30 × 40
120				25 × 30	25 × 35	
150		22 × 25	22 × 40 25 × 30	22 × 40 25 × 30	30 × 35	30 × 50
180					30 × 35	
220	22 × 25	22 × 30 25 × 25	25 × 40 30 × 35	25 × 40 30 × 30	30 × 50	
270				30 × 35	30 × 45	
330	22 × 30 25 × 25	22 × 40 25 × 35	30 × 45	30 × 45	35 × 40	
390				30 × 45 35 × 40	35 × 45	
470	22 × 40 30 × 25	25 × 40 30 × 30	35 × 40	35 × 45	35 × 50	
560			35 × 45	35 × 50		
680	25 × 40 30 × 35	30 × 40		35 × 55		
1 000	30 × 45 35 × 40	35 × 45				
1 200	35 × 45	35 × 50				
1 500	35 × 50					

The capacitance and voltage ratings listed above are available in different cases upon request.

Other voltage and capacitance ratings are also available upon request.

**Technical data and ordering codes**

$U_R$	$C_R$	Case dimensions	$ESR_{max}$	$Z_{max}$	$I_{-max}$	$I_{-R}^{1)}$	Ordering code <sup>2)</sup>
VDC	100 Hz 20 °C μF	$d \times l$ mm	100 Hz 20 °C mΩ	10 kHz 20 °C mΩ	100 Hz 40 °C A	100 Hz 85 °C A	

**B41303**

10	10 000	22 × 30	66	59	4,7	1,8	B41303A3109M000
	10 000	25 × 25	66	59	4,7	1,8	B41303J3109M000
	15 000	22 × 35	54	49	5,6	2,2	B41303B3159M000
	15 000	25 × 30	54	49	5,6	2,2	B41303J3159M000
	22 000	25 × 40	46	43	6,7	2,6	B41303A3229M000
	22 000	30 × 30	46	43	6,7	2,6	B41303J3229M000
	33 000	30 × 35	41	39	7,3	2,8	B41303B3339M000
	47 000	30 × 45	38	36	8,3	3,2	B41303B3479M000
16	6 800	22 × 30	71	59	4,5	1,8	B41303A4688M000
	6 800	25 × 25	71	59	4,5	1,8	B41303J4688M000
	10 000	22 × 35	58	52	5,2	2,0	B41303B4109M000
	10 000	25 × 30	58	52	5,2	2,0	B41303J4109M000
	15 000	25 × 40	49	45	6,4	2,5	B41303A4159M000
	15 000	30 × 30	49	45	6,4	2,5	B41303J4159M000
	22 000	30 × 35	43	40	7,3	2,8	B41303B4229M000
	33 000	30 × 45	39	37	8,1	3,1	B41303B4339M000
25	4 700	22 × 30	77	67	4,4	1,7	B41303A5478M000
	4 700	25 × 25	77	67	4,4	1,7	B41303J5478M000
	6 800	22 × 35	62	56	4,9	1,9	B41303B5688M000
	6 800	25 × 30	62	56	4,9	1,9	B41303J5688M000
	10 000	25 × 35	52	48	5,5	2,3	B41303B5109M000
	10 000	30 × 30	52	48	5,5	2,3	B41303J5109M000
	15 000	30 × 35	45	42	7,0	2,7	B41303B5159M000
	22 000	30 × 45	40	38	8,1	3,1	B41303B5229M000

Preferred types

1) 120 Hz conversion factor of ripple current:  $I_{-}(120\text{ Hz}) = 1,03 \cdot I_{-}(100\text{ Hz})$

2) Ordering code for standard terminals (6,3 mm).

To determine the ordering code for short terminals (4,5 mm) and 3 terminals (4,5 mm) see page 213.

**B41303 / B43303**
**Standard – 85 °C**

$U_R$	$C_R$ 100 Hz 20 °C	Case dimensions $d \times l$ mm	$ESR_{max}$ 100 Hz 20 °C mΩ	$Z_{max}$ 10 kHz 20 °C mΩ	$I_{-max}$ 100 Hz 40 °C A	$I_{-R}^{(1)}$ 100 Hz 85 °C A	Ordering code <sup>2)</sup>
VDC	μF						
40	3 300	22 × 30	77	71	4,4	1,7	B41303A7338M000
	3 300	25 × 25	77	71	4,4	1,7	B41303J7338M000
	4 700	22 × 35	66	59	4,9	1,9	B41303B7478M000
	4 700	25 × 30	66	59	4,9	1,9	B41303J7478M000
	6 800	25 × 40	55	50	6,1	2,4	B41303A7688M000
	6 800	30 × 30	55	50	6,1	2,4	B41303J7688M000
	10 000	30 × 35	47	44	6,8	2,6	B41303B7109M000
	15 000	30 × 50	41	39	8,4	3,3	B41303A7159M000
63	1 500	22 × 30	120	100	3,5	1,4	B41303A8158M000
	1 500	25 × 25	120	100	3,5	1,4	B41303J8158M000
	2 200	22 × 35	89	77	4,2	1,6	B41303B8228M000
	2 200	25 × 30	89	77	4,2	1,6	B41303J8228M000
	3 300	25 × 35	69	62	5,2	2,0	B41303B8338M000
	3 300	30 × 30	69	62	5,2	2,0	B41303J8338M000
	4 700	30 × 35	58	52	6,2	2,4	B41303B8478M000
	6 800	30 × 45	49	45	7,3	2,8	B41303B8688M000
100	680	22 × 30	180	150	2,9	1,1	B41303A9687M000
	680	25 × 25	180	150	2,9	1,1	B41303J9687M000
	1 000	22 × 35	130	110	3,4	1,3	B41303B9108M000
	1 000	25 × 30	130	110	3,4	1,3	B41303J9108M000
	1 500	25 × 35	97	83	4,4	1,7	B41303B9158M000
	1 500	30 × 30	97	83	4,4	1,7	B41303J9158M000
	2 200	30 × 35	75	66	5,5	2,1	B41303B9228M000
	3 300	30 × 45	60	54	6,5	2,5	B41303B9338M000

Preferred types

1) 120 Hz conversion factor of ripple current:  $I_{-}(120 \text{ Hz}) = 1,03 \cdot I_{-}(100 \text{ Hz})$

2) Ordering code for standard terminals (6,3 mm).

To determine the ordering code for short terminals (4,5 mm) and 3 terminals (4,5 mm) see page 213.



**Technical data and ordering codes**

$U_R$	$C_R$ 100 Hz 20 °C	Case dimensions $d \times l$ mm	$ESR_{max}$ 100 Hz 20 °C mΩ	$Z_{max}$ 10 kHz 20 °C mΩ	$I_{-max}$ 100 Hz 40 °C A	$I_{-R}^{1)}$ 100 Hz 85 °C A	Ordering code <sup>2)</sup>
VDC	μF						
<b>B43303 (not for new design)</b>							
200	220	22 × 25	1250	960	1,7	0,77	B43303D0227M000
	330	22 × 30	900	640	2,2	1,0	B43303D0337M000
	330	25 × 25	800	640	2,3	1,0	B43303M0337M000
	470	22 × 40	560	450	2,9	1,3	B43303D0477M000
	470	30 × 25	560	450	3,0	1,3	B43303M0477M000
	680	25 × 40	390	310	3,8	1,7	B43303D0687M000
	680	30 × 35	390	310	4,0	1,8	B43303M0687M000
	1 000	30 × 45	260	210	5,3	2,4	B43303D0108M000
	1 000	35 × 40	260	210	5,6	2,5	B43303E0108M000
	1 200	35 × 45	220	180	6,4	2,9	B43303A0128M000
1 500	35 × 50	180	140	7,4	3,3	B43303A0158M000	
250	150	22 × 25	1400	1200	1,4	0,63	B43303C2157M000
	220	22 × 30	920	740	1,8	0,82	B43303C2227M000
	220	25 × 25	920	740	1,8	0,84	B43303L2227M000
	330	22 × 40	620	500	2,5	1,1	B43303C2337M000
	330	25 × 35	620	500	2,5	1,2	B43303L2337M000
	470	25 × 40	440	360	3,2	1,4	B43303C2477M000
	470	30 × 30	440	360	3,1	1,4	B43303L2477M000
	680	30 × 40	300	240	4,2	1,9	B43303C2687M000
	1 000	35 × 45	220	170	5,8	2,6	B43303A2108M000
	1 200	35 × 50	180	150	6,6	3,0	B43303A2128M000
385	68	22 × 25	2700	2200	1,0	0,45	B43303H0686M000
	100	22 × 30	1800	1500	1,3	0,58	B43303H0107M000
	100	25 × 25	1800	1500	1,3	0,59	B43303R0107M000
	150	22 × 40	1200	940	1,7	0,79	B43303H0157M000
	150	25 × 30	1200	940	1,7	0,77	B43303R0157M000
	220	25 × 40	800	640	2,3	1,0	B43303H0227M000
	220	30 × 35	800	640	2,4	1,1	B43303P0227M000
	330	30 × 45	540	440	3,2	1,4	B43303H0337M000
	470	35 × 40	410	330	4,1	1,8	B43303E0477M000
	560	35 × 45	340	280	4,7	2,1	B43303A0567M000

1) 120 Hz conversion factor of ripple current:  $I_{-} (120 \text{ Hz}) = 1,03 \cdot I_{-} (100 \text{ Hz})$

2) Ordering code for standard terminals (6,3 mm).

To determine the ordering code for short terminals (4,5 mm) and 3 terminals (4,5 mm) see page 213.



$U_R$	$C_R$ 100 Hz 20 °C μF	Case dimensions $d \times l$ mm	$ESR_{max}$ 100 Hz 20 °C mΩ	$Z_{max}$ 10 kHz 20 °C mΩ	$I_{-max}$ 100 Hz 40 °C A	$I_{-R}^{1)}$ 100 Hz 85 °C A	Ordering code <sup>2)</sup>
400	68	22 × 30	2400	2000	1,0	0,48	B43303G0686M000
	100	22 × 35	1600	1420	1,3	0,61	B43303G0107M000
	100	25 × 30	1600	1420	1,4	0,63	B43303Q0107M000
	120	25 × 30	1350	1180	1,5	0,69	B43303A9127M000
	150	22 × 40	1100	920	1,7	0,79	B43303A9157M000
	150	25 × 30	1100	920	1,7	0,77	B43303B9157M000
	220	25 × 40	700	630	2,2	1,0	B43303B9227M000
	220	30 × 30	700	630	2,2	1,0	B43303A9227M000
	270	30 × 35	580	520	2,6	1,2	B43303A9277M000
	330	30 × 45	450	420	3,2	1,4	B43303G0337M000
	390	30 × 45	400	360	3,5	1,6	B43303A9397M000
	390	35 × 40	440	350	3,7	1,7	B43303A0397M000
	470	35 × 45	360	290	4,3	1,9	B43303F0477M000
	560	35 × 50	300	240	4,9	2,2	B43303F0567M000
680	35 × 55	250	200	5,6	2,5	B43303A0687M000	
450	68	22 × 35	3700	3080	1,1	0,50	B43303A5686M000
	100	22 × 40	2500	2080	1,4	0,64	B43303B5107M000
	120	25 × 35	2100	1730	1,6	0,72	B43303A5127M000
	150	30 × 35	1700	1420	1,9	0,88	B43303A5157M000
	180	30 × 35	1370	1180	2,1	0,97	B43303A5187M000
	220	30 × 50	1200	1000	2,7	1,2	B43303A5227M000
	270	30 × 45	910	790	2,9	1,3	B43303A5277M000
	330	35 × 40	840	670	3,4	1,5	B43303A5337M000
	390	35 × 45	710	570	3,9	1,8	B43303A5397M000
	470	35 × 50	590	470	4,5	2,0	B43303A5477M000
500	22	22 × 25	9200	7700	0,52	0,24	B43303A6226M000
	33	22 × 30	6200	5200	0,68	0,31	B43303A6336M000
	47	22 × 40	4400	3700	0,91	0,41	B43303A6476M000
	68	25 × 40	3000	2500	1,2	0,54	B43303A6686M000
	100	30 × 40	2100	1800	1,6	0,71	B43303A6107M000
	150	30 × 50	1400	1200	2,1	0,94	B43303A6157M000

1) 120 Hz conversion factor of ripple current:  $I_{-}(120\text{ Hz}) = 1,03 \cdot I_{-}(100\text{ Hz})$

2) Ordering code for standard terminals (6,3 mm).

To determine the ordering code for short terminals (4,5 mm) and 3 terminals (4,5 mm) see page 213.

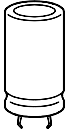

**B41303 / B43303**

**Standard – 85 °C**

**Useful life**

depending on ambient temperature  $T_A$  under ripple current operating conditions<sup>1)</sup>

$U_R \leq 100$  VDC

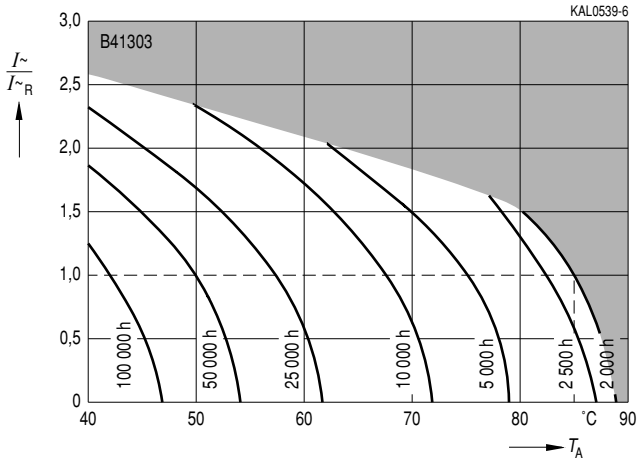

$U_R \geq 200$  VDC

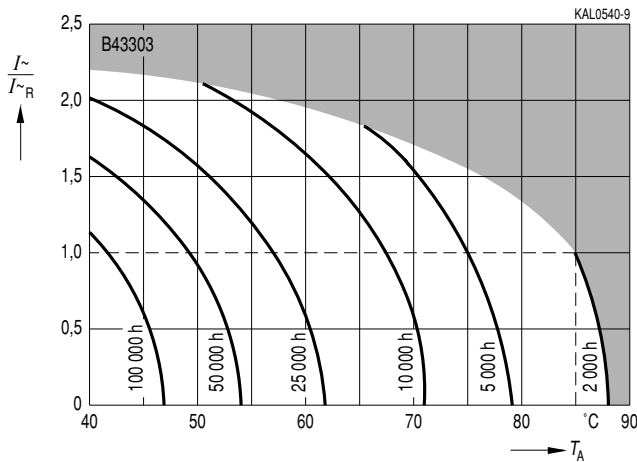

1) Refer to page 40 for an explanation on how to interpret the useful life graphs.

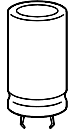

**Frequency factor of permissible ripple current  $I_{\sim}$  versus frequency  $f$**   
 $U_R \leq 100$  VDC

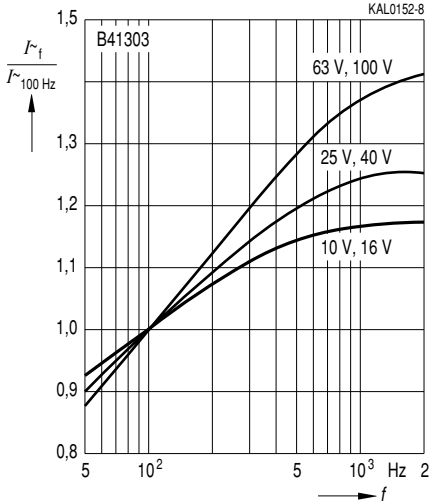

**Frequency factor of permissible ripple current  $I_{\sim}$  versus frequency  $f$**   
 $U_R \geq 200$  VDC

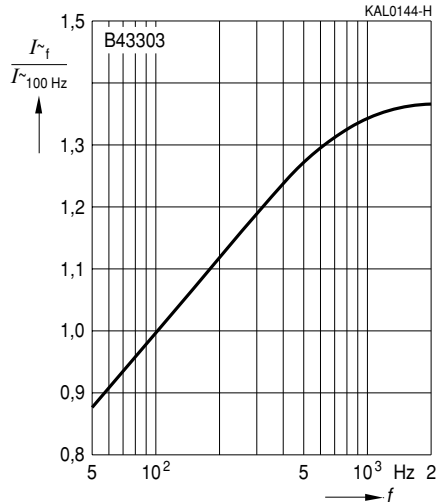

**Frequency characteristics of ESR**  
 Typical behavior  
 $U_R \leq 100$  VDC

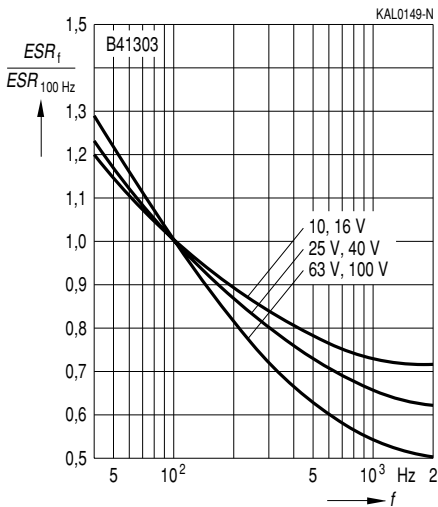

**Frequency characteristics of ESR**  
 Typical behavior  
 $U_R \geq 200$  VDC

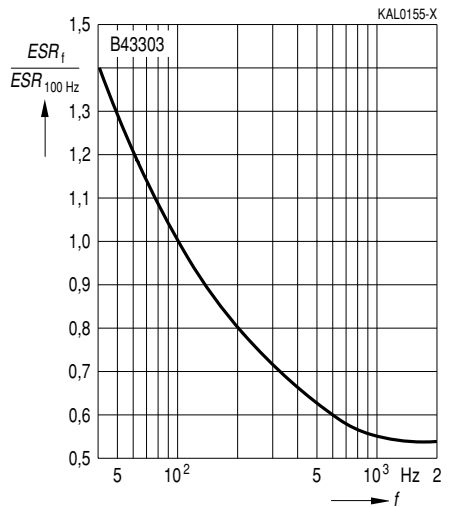

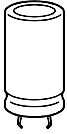

**B41303 / B43303**

**Standard – 85 °C**

**Impedance  $Z$**

versus frequency  $f$

Typical behavior at 20 °C

$U_R \leq 100$  VDC

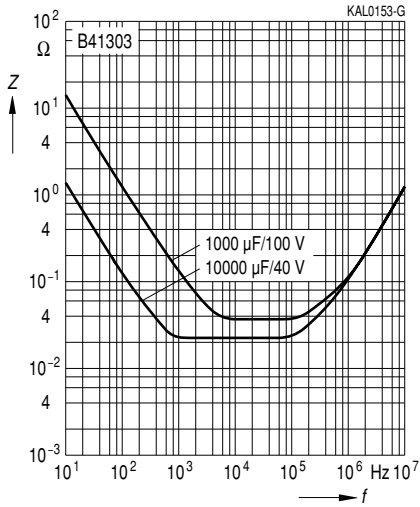

**Impedance  $Z$**

versus frequency  $f$  at different temperatures  $T$

for 100 μF/400 VDC

Typical behavior

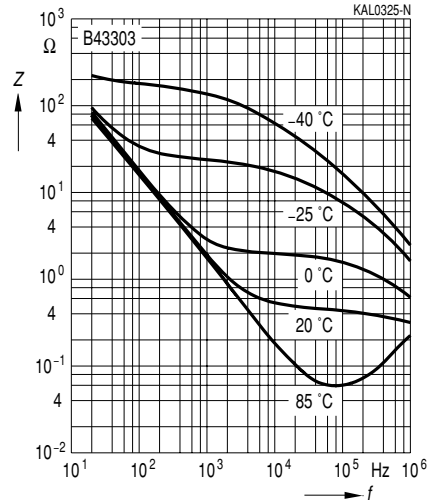

**Herausgegeben von EPCOS AG**

**Unternehmenskommunikation, Postfach 80 17 09, 81617 München, DEUTSCHLAND**

**☎ ++49 89 636 09, FAX (0 89) 636-2 26 89**

© EPCOS AG 2002. Vervielfältigung, Veröffentlichung, Verbreitung und Verwertung dieser Broschüre und ihres Inhalts ohne ausdrückliche Genehmigung der EPCOS AG nicht gestattet.

Bestellungen unterliegen den vom ZVEI empfohlenen Allgemeinen Lieferbedingungen für Erzeugnisse und Leistungen der Elektroindustrie, soweit nichts anderes vereinbart wird.

Diese Broschüre ersetzt die vorige Ausgabe.

Fragen über Technik, Preise und Liefermöglichkeiten richten Sie bitte an den Ihnen nächstgelegenen Vertrieb der EPCOS AG oder an unsere Vertriebsgesellschaften im Ausland. Bauelemente können aufgrund technischer Erfordernisse Gefahrstoffe enthalten. Auskünfte darüber bitten wir unter Angabe des betreffenden Typs ebenfalls über die zuständige Vertriebsgesellschaft einzuholen.

**Published by EPCOS AG**

**Corporate Communications, P.O. Box 80 17 09, 81617 Munich, GERMANY**

**☎ ++49 89 636 09, FAX (0 89) 636-2 26 89**

© EPCOS AG 2002. Reproduction, publication and dissemination of this brochure and the information contained therein without EPCOS' prior express consent is prohibited.

Purchase orders are subject to the General Conditions for the Supply of Products and Services of the Electrical and Electronics Industry recommended by the ZVEI (German Electrical and Electronic Manufacturers' Association), unless otherwise agreed.

This brochure replaces the previous edition.

For questions on technology, prices and delivery please contact the Sales Offices of EPCOS AG or the international Representatives.

Due to technical requirements components may contain dangerous substances. For information on the type in question please also contact one of our Sales Offices.