

## Long-life grade capacitors

### Applications

- Frequency converters
- Professional power supplies
- Uninterruptible power supplies

### Features

- Extremely compact, i. e. high CU product
- High reliability and ripple current capability
- All-welded construction ensures reliable electrical contact
- Version with optimized construction for base cooling (2-pad solution) available
- Version with low-inductance design available

### Construction

- Charge-discharge proof, polar
- Aluminum case with insulating sleeve
- Poles with screw terminal connections
- Mounting with ring clips, clamps or threaded stud
- The bases of types with threaded stud and  $d \leq 76,9$  mm are not insulated, types with  $d = 91$  mm have fully insulated bases

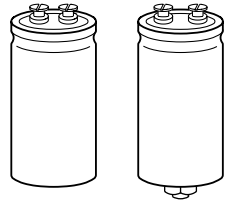

B43456

KAL0567-B

B43458

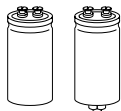

**B43456 / B43458**

**Compact – 85 °C**

### Specifications and characteristics in brief

Rated voltage $U_R$	350 ... 450 VDC	
Surge voltage $U_S$	$1,10 \cdot U_R$	
Rated capacitance $C_R$	1 000 ... 18 000 $\mu$ F	
Capacitance tolerance	$\pm 20 \% \triangleq M$	
Leakage current $I_L$ (5 min, 20 °C)	$I_L \leq 0,3 \mu A \cdot \left( \frac{C_R}{\mu F} \cdot \frac{U_R}{V} \right)^{0,7} + 4 \mu A$	
Self-inductance $ESL$	Approx. 20 nH Capacitors with low inductance design: $d \geq 64,3$ mm: approx. 13 nH	
Useful life 85 °C; $U_R$ ; $I_{\sim R}$ 40 °C; $U_R$ ; $1,5 \cdot I_{\sim R}$	> 12 000 h > 250 000 h	Requirements: $\Delta C/C \leq \pm 30 \%$ of initial value $ESR \leq 3$ times initial specified limit $I_L \leq$ initial specified limit Failure percentage: $\leq 1 \%$ Failure rate: $\leq 40$ fit ( $\leq 40 \cdot 10^{-9}/h$ ) (for definition "fit", refer to chapter "Quality", page 62)
Voltage endurance test 85 °C; $U_R$	2 000 h	Post test requirements: $\Delta C/C \leq \pm 10 \%$ of initial value $ESR \leq 1,3$ times initial specified limit $I_L \leq$ initial specified limit
Vibration resistance	To IEC 60068-2-6, test Fc: displacement amplitude 0,75 mm, frequency range 10 to 55 Hz, acceleration max. 10 g, duration $3 \times 2$ h	
IEC climatic category	To IEC 60068-1: $U_R \leq 400$ VDC: 40/085/56 (– 40 °C/+ 85 °C/56 days damp heat test) $U_R = 450$ VDC: 25/085/56 (– 25 °C/+ 85 °C/56 days damp heat test)	
Detail specifications	Similar to CECC 30301-803, CECC 30301-807	
Sectional specification	IEC 60384-4	

### Ripple current capability

Due to the ripple current capability of the contact elements, the following current upper limits must not be exceeded:

Capacitor diameter	51,6 mm	64,3 mm	76,9 mm	91,0 mm
$I_{\sim max}$	30 A	40 A	50 A	70 A

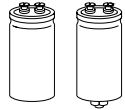
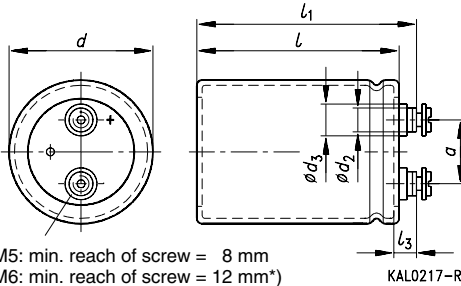
**Dimensional drawings**
**Type B43456**  
 Ring clip/clamp mounting

M5: min. reach of screw = 8 mm  
 M6: min. reach of screw = 12 mm\*)  
 \*) 8 mm for low-inductance design

KAL0217-R

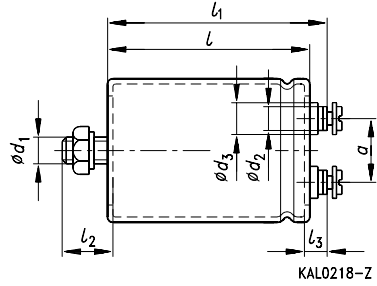
**Type B43458**  
 Threaded stud mounting

KAL0218-Z

Positive pole marking: +

The base of types with threaded stud and  $d = 91$  mm is fully insulated (the lengths  $l$  and  $l_1$  are increased by 0,5 mm in these cases). For types with threaded stud and  $d \leq 76$  mm the base is not insulated. Also refer to the notes on mounting given on page 168.

Screw terminals with UNF threads are available upon request.

**Dimensions and weights**

Ter- minal	Dimensions (mm) with insulating sleeve										Approx. wt. (g)
	$d$	$l \pm 1$	$l_1 \pm 1$	$l_2 \begin{smallmatrix} +0 \\ -1 \end{smallmatrix}$	$l_3$	$d_1$	$d_2$ max	$d_3$ max	$a \begin{smallmatrix} +0,2 \\ -0,4 \end{smallmatrix}$		
M 5	51,6 +0/-0,8	80,7	87,2	17	7,0 +0,2/-1	M 12	8,2	13,5	22,2	220	
M 5	51,6 +0/-0,8	105,7	112,2	17	7,0 +0,2/-1	M 12	8,2	13,5	22,2	280	
M 5	64,3 +0/-0,8	105,7	112,2	17	7,0 +0,2/-1	M 12	8,2	13,5	28,5	440	
M 6	76,9 +0/-0,7	105,7	111,5	17	6,4 +1,1/-0,8	M 12	17,7	17,7	31,7	540	
M 6	76,9 +0/-0,7	143,2	149,0	17	6,4 +1,1/-0,8	M 12	17,7	17,7	31,7	840	
M 6	76,9 +0/-0,7	220,7	226,5	17	6,4 +1,1/-0,8	M 12	17,7	17,7	31,7	1300	
M 6	91,0 +0/-2	144,5	149,8	17	6,4 +1,1/-0,8	M 12	17,7	17,7	31,7	1200	
M 6	91,0 +0/-2	221,0	226,3	17	6,4 +1,1/-0,8	M 12	17,7	17,7	31,7	1900	

Dimensions are also valid for 2-pad solution and low-inductance design.

**Packing**

For ecological reasons the packing is pure cardboard.

Capacitor diameter $d$	Packing units (pieces)	Capacitor diameter $d$	Packing units (pieces)
51,6 mm	22	76,9 mm	12
64,3 mm	15	91,0 mm	8

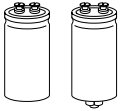

**B43456 / B43458**

**Compact – 85 °C**

### Special designs

- Low-inductance design
- 2-pad solution

Design for optimized connection of the capacitor to the heatsink when using base cooling. This version is available for capacitors without threaded stud and for diameters  $\geq 64,3$  mm (cf.  $I_{-R}(B)$  in table “Technical data and ordering codes” and useful life graphs).

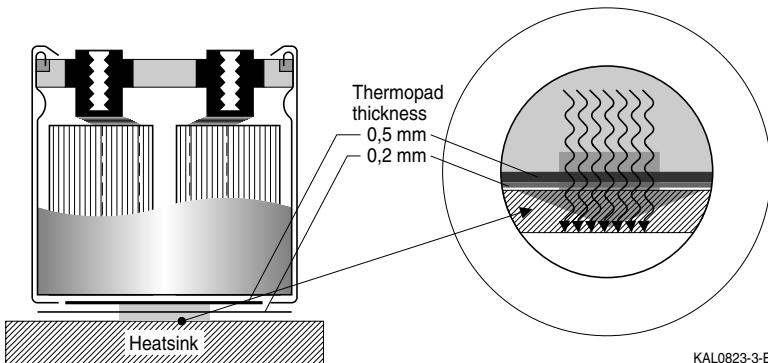

KAL0823-3-E

Ordering codes:

Design	Identification in 3rd block of ordering code	Remark
Low inductance (13 nH)	M003	For capacitors with diameter $d \geq 64,3$ mm
2-pad solution	M006	For capacitors with diameter $d \geq 64,3$ mm and without threaded stud

### Accessories

The following items are included in the delivery package, but are not fastened to the capacitors:

	Thread	Toothed washers	Screws/Nuts	Maximum torque
For terminals	M 5	A 5,1 DIN 6797	Cylinder-head screw M 5 $\times$ 8 DIN 84-4.8	2 Nm
	M 6	A 6,4 DIN 6797	Cylinder-head screw M 6 $\times$ 12 DIN 85-4.8	2,5 Nm
For mounting	M 12	J 12,5 DIN 6797	Hex nut BM 12 DIN 439	10 Nm

The following must be ordered separately:

Ring clips

B 44 030 (cf. page 169)

Clamps for capacitors with  $d \geq 64,3$  mm

B 44 030 (cf. page 173)

Insulating parts

B 44 020 (cf. page 166)

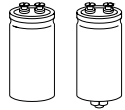
**Overview of available types**

$U_R$ (VDC)	350	400	450
$C_R$ ( $\mu$ F)	Case dimensions $d \times l$ (mm)		
1 000		51,6 × 80,7	51,6 × 80,7
1 500	51,6 × 80,7	51,6 × 80,7	51,6 × 105,7
2 200	51,6 × 105,7	51,6 × 105,7	64,3 × 105,7
3 300		64,3 × 105,7	76,9 × 105,7
3 900	64,3 × 105,7		
4 700		76,9 × 105,7	
5 600	76,9 × 105,7		76,9 × 143,2
6 800		76,9 × 143,2	91,0 × 144,5
8 200	76,9 × 143,2		76,9 × 220,7
10 000		91,0 × 144,5	
12 000	91,0 × 144,5	76,9 × 220,7	91,0 × 221,0
15 000	76,9 × 220,7	91,0 × 221,0	
18 000	91,0 × 221,0		

The capacitance and voltage ratings listed above are available in different cases upon request. Other voltage and capacitance ratings are also available upon request.

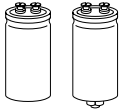

**B43456 / B43458**
**Compact – 85 °C**
**Technical data and ordering codes**

$U_R$	$C_R$ 100 Hz 20 °C μF	Case dimensions $d \times l$ mm	$ESR_{max}$ 100 Hz 20 °C mΩ	$Z_{max}$ 10 kHz 20 °C mΩ	$I_{~max}$ 100 Hz 40 °C A	$I_{~R}$ 100 Hz 85 °C A	$I_{~R(B)}$ 100 Hz 85 °C A	Ordering code <sup>1)</sup>
350	1 500	51,6 × 80,7	110	93	16	5,7	11	B4345*A4158M000
	2 200	51,6 × 105,7	73	63	21	7,6	14	B4345*A4228M000
	3 900	64,3 × 105,7	41	38	32	12	21	B4345*A4398M000 <sup>2)</sup>
	5 600	76,9 × 105,7	29	28	43	15	30	B4345*A4568M000 <sup>2)</sup>
	8 200	76,9 × 143,2	20	20	50	20	36	B4345*A4828M000 <sup>2)</sup>
	12 000	91,0 × 144,5	14	14	70	28	52	B4345*A4129M000 <sup>2)</sup>
	15 000	76,9 × 220,7	11	11	50	34	50	B4345*A4159M000 <sup>2)</sup>
	18 000	91,0 × 221,0	9	9	70	38	58	B4345*A4189M000 <sup>2)</sup>
400	1 000	51,6 × 80,7	160	133	13	4,6	8,2	B4345*A9108M000
	1 500	51,6 × 80,7	110	93	17	6,0	13	B4345*A9158M000
	2 200	51,6 × 105,7	73	63	22	8,0	15	B4345*A9228M000
	3 300	64,3 × 105,7	49	44	30	11	20	B4345*A9338M000 <sup>2)</sup>
	4 700	76,9 × 105,7	34	32	40	14	29	B4345*A9478M000 <sup>2)</sup>
	6 800	76,9 × 143,2	24	24	50	19	33	B4345*A9688M000 <sup>2)</sup>
	10 000	91,0 × 144,5	16	16	70	25	48	B4345*A9109M000 <sup>2)</sup>
	12 000	76,9 × 220,7	14	14	50	31	46	B4345*A9129M000 <sup>2)</sup>
	15 000	91,0 × 221,0	11	11	70	35	54	B4345*A9159M000 <sup>2)</sup>
450	1 000	51,6 × 80,7	220	190	13	4,8	9,6	B4345*A5108M000
	1 500	51,6 × 105,7	150	130	18	6,5	12	B4345*A5158M000
	2 200	64,3 × 105,7	100	85	24	8,4	15	B4345*A5228M000 <sup>2)</sup>
	3 300	76,9 × 105,7	65	57	32	12	23	B4345*A5338M000 <sup>2)</sup>
	5 600	76,9 × 143,2	38	35	49	17	31	B4345*A5568M000 <sup>2)</sup>
	6 800	91,0 × 144,5	32	31	57	20	37	B4345*A5688M000 <sup>2)</sup>
	8 200	76,9 × 220,7	26	26	50	24	36	B4345*A5828M000 <sup>2)</sup>
	12 000	91,0 × 221,0	18	18	70	32	51	B4345*A5129M000 <sup>2)</sup>

Preferred types

1) \* "6" = for capacitors with ring clip/clamp mounting  
"8" = for capacitors with threaded stud

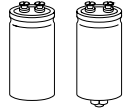
2) For 2-pad solution (types without threaded stud) and for low-inductance design, see page 128.



**Useful life**

depending on ambient temperature  $T_A$  (for natural cooling) and versus temperature of case base  $T_B$  (for base cooling) under ripple current operating conditions<sup>1)</sup>

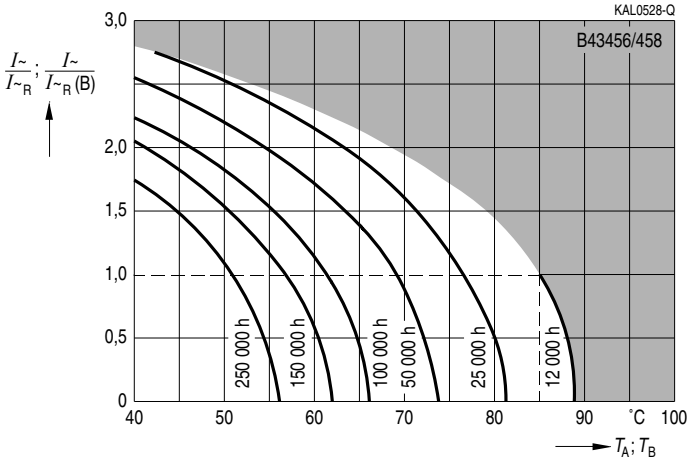

**Frequency factor of permissible ripple current  $I_{\sim}$  versus frequency  $f$**

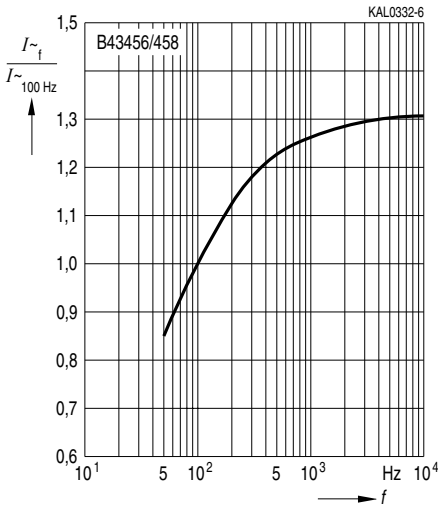

1) The ripple current refers to  $I_{\sim R}$  for natural cooling or to  $I_{\sim R(B)}$  for base cooling, respectively. Refer to page 40 for an explanation on how to interpret the useful life graphs.

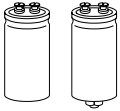

**B43456 / B43458**

**Compact – 85 °C**

**Frequency characteristics of ESR**

Typical behavior

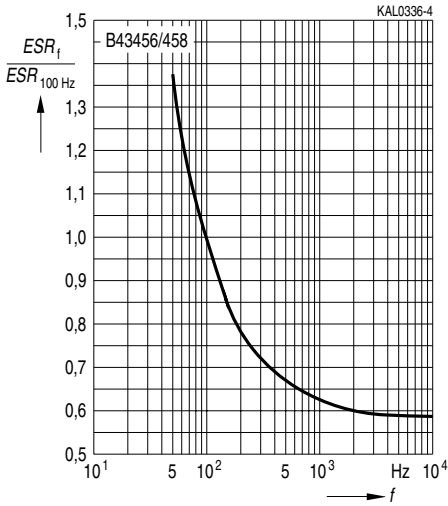

**Impedance Z**

versus frequency  $f$

Typical behavior at 20 °C

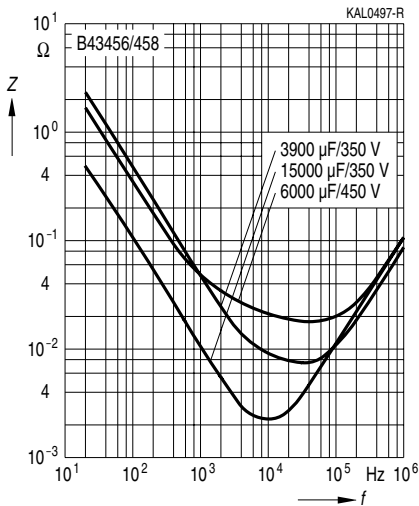



**Herausgegeben von EPCOS AG**

**Unternehmenskommunikation, Postfach 80 17 09, 81617 München, DEUTSCHLAND**

**☎ ++49 89 636 09, FAX (0 89) 636-2 26 89**

© EPCOS AG 2002. Vervielfältigung, Veröffentlichung, Verbreitung und Verwertung dieser Broschüre und ihres Inhalts ohne ausdrückliche Genehmigung der EPCOS AG nicht gestattet.

Bestellungen unterliegen den vom ZVEI empfohlenen Allgemeinen Lieferbedingungen für Erzeugnisse und Leistungen der Elektroindustrie, soweit nichts anderes vereinbart wird.

Diese Broschüre ersetzt die vorige Ausgabe.

Fragen über Technik, Preise und Liefermöglichkeiten richten Sie bitte an den Ihnen nächstgelegenen Vertrieb der EPCOS AG oder an unsere Vertriebsgesellschaften im Ausland. Bauelemente können aufgrund technischer Erfordernisse Gefahrstoffe enthalten. Auskünfte darüber bitten wir unter Angabe des betreffenden Typs ebenfalls über die zuständige Vertriebsgesellschaft einzuholen.

**Published by EPCOS AG**

**Corporate Communications, P.O. Box 80 17 09, 81617 Munich, GERMANY**

**☎ ++49 89 636 09, FAX (0 89) 636-2 26 89**

© EPCOS AG 2002. Reproduction, publication and dissemination of this brochure and the information contained therein without EPCOS' prior express consent is prohibited.

Purchase orders are subject to the General Conditions for the Supply of Products and Services of the Electrical and Electronics Industry recommended by the ZVEI (German Electrical and Electronic Manufacturers' Association), unless otherwise agreed.

This brochure replaces the previous edition.

For questions on technology, prices and delivery please contact the Sales Offices of EPCOS AG or the international Representatives.

Due to technical requirements components may contain dangerous substances. For information on the type in question please also contact one of our Sales Offices.