

B5817WS-B5819WS

Rev.F Mar.-2016

描述 / Descriptions

SOD-323 塑封封装 肖特基二极管。
Schottky Diode in a SOD-323 Plastic Package.

特征 / Features

低正向压降。
Low positive pressure drop.

用途 / Applications

肖特基二极管。
Schottky Diode.

内部等效电路 / Equivalent Circuit

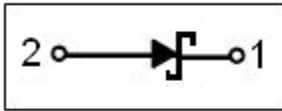

引脚排列 / Pinning



PIN1:Cathode PIN2:Anode

放大及印章代码 / h_{FE} Classifications & Marking

Model	B5817WS	B5818WS	B5819WS
Marking	HSJ	HSK	HSL

极限参数 / Absolute Maximum Ratings(Ta=25°C)

参数 Parameter	符号 Symbol	数值 Rating			单位 Unit
		B5817WS	B5818WS	B5819WS	
Peak Repetitive Reverse Voltage , Working Peak Reverse Voltage, DC Reverse Voltage	V_{RRM} V_{RWM} V_R	20	30	40	V
RMS Reverse Voltage	$V_{R(RMS)}$	14	21	28	V
Average Rectified Forward Current	I_F	1			A
Non-Repetitive Peak Forward Surge Current	I_{FSM}	25			A
Power Dissipation	P_d	200			mW
Typical Thermal Resistance Junction to Ambient	$R_{\theta JA}$	500			°C/W
Junction and Storage Temperature Range	T_J, T_{stg}	-65 to 125			°C

电性能参数 / Electrical Characteristics(Ta=25°C)

参数 Parameter	符号 Symbol	测试条件 Test Conditions	数值 Rating		单位 Unit
			MIN	MAX	
Reverse breakdown voltage	$V_{(BR)}$	$I_R=100\mu A$	B5817WS	20	V
			B5818WS	30	
			B5819WS	40	
Peak Forward Voltage	V_{FM}	$I_F=0.1A$	B5817WS	0.32	V
			B5818WS	0.35	
			B5819WS	0.4	
		$I_F=1A$	B5817WS	0.45	
			B5818WS	0.55	
			B5819WS	0.65	
		$I_F=3A$	B5817WS	0.75	
			B5818WS	0.80	
			B5819WS	0.90	
Instantaneous Reverse Current	I_{RM}	$V_R=V_{RWM}$	1		mA
Junction Capacitance	C_J	$V_R=4V$ $f=1.0MHz$	120		pF

电参数曲线图 / Electrical Characteristic Curve

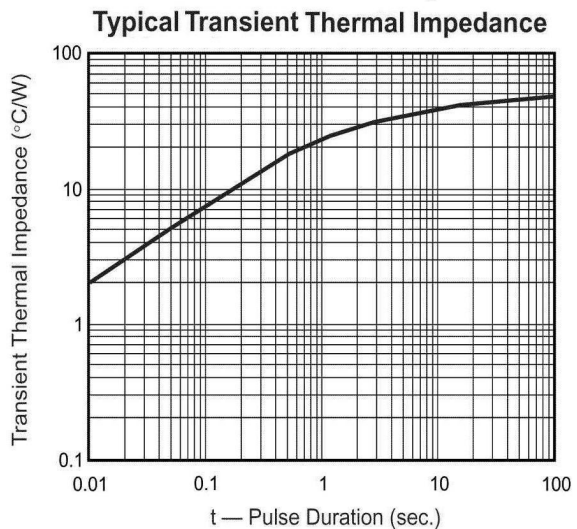
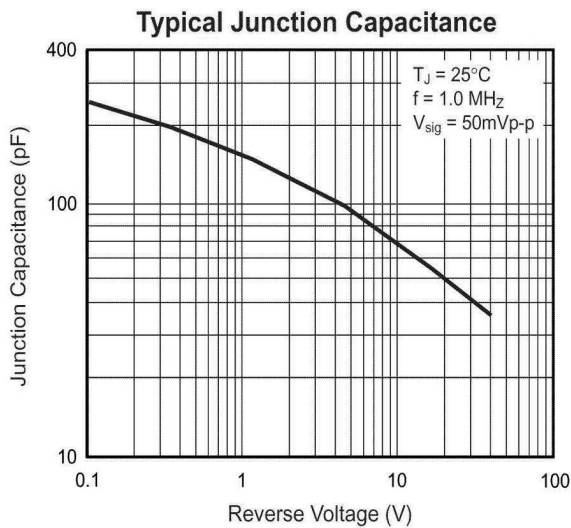
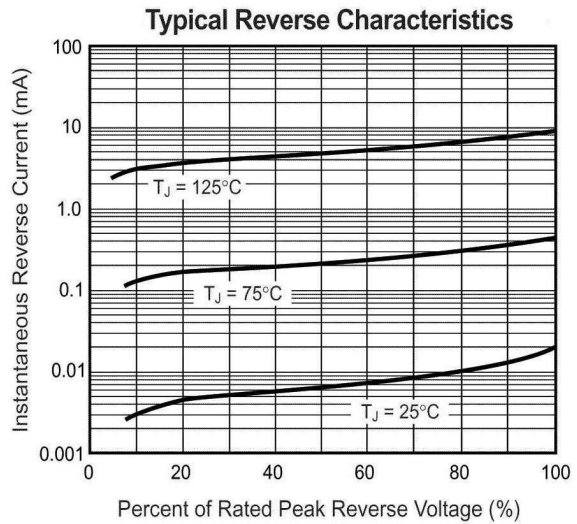
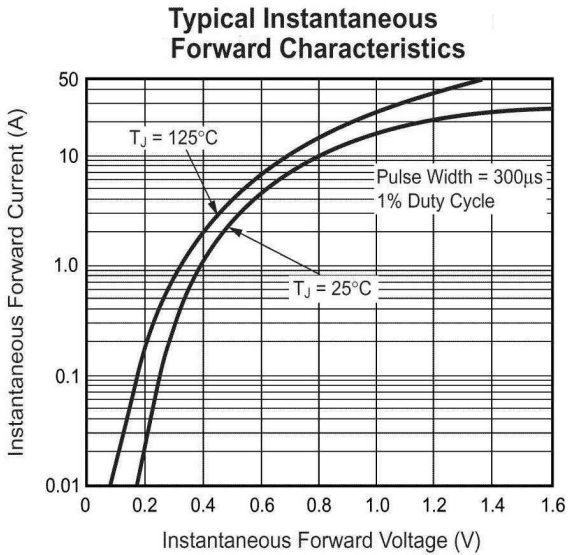
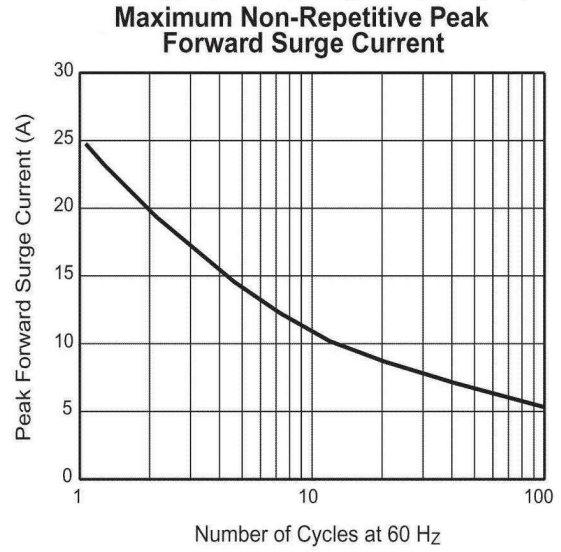
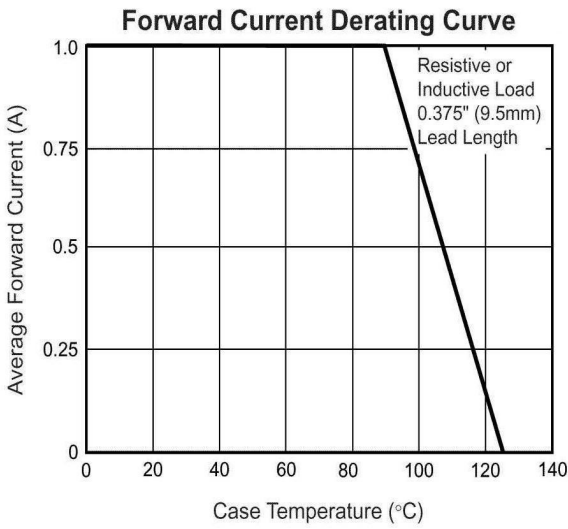

外形尺寸图 / Package Dimensions

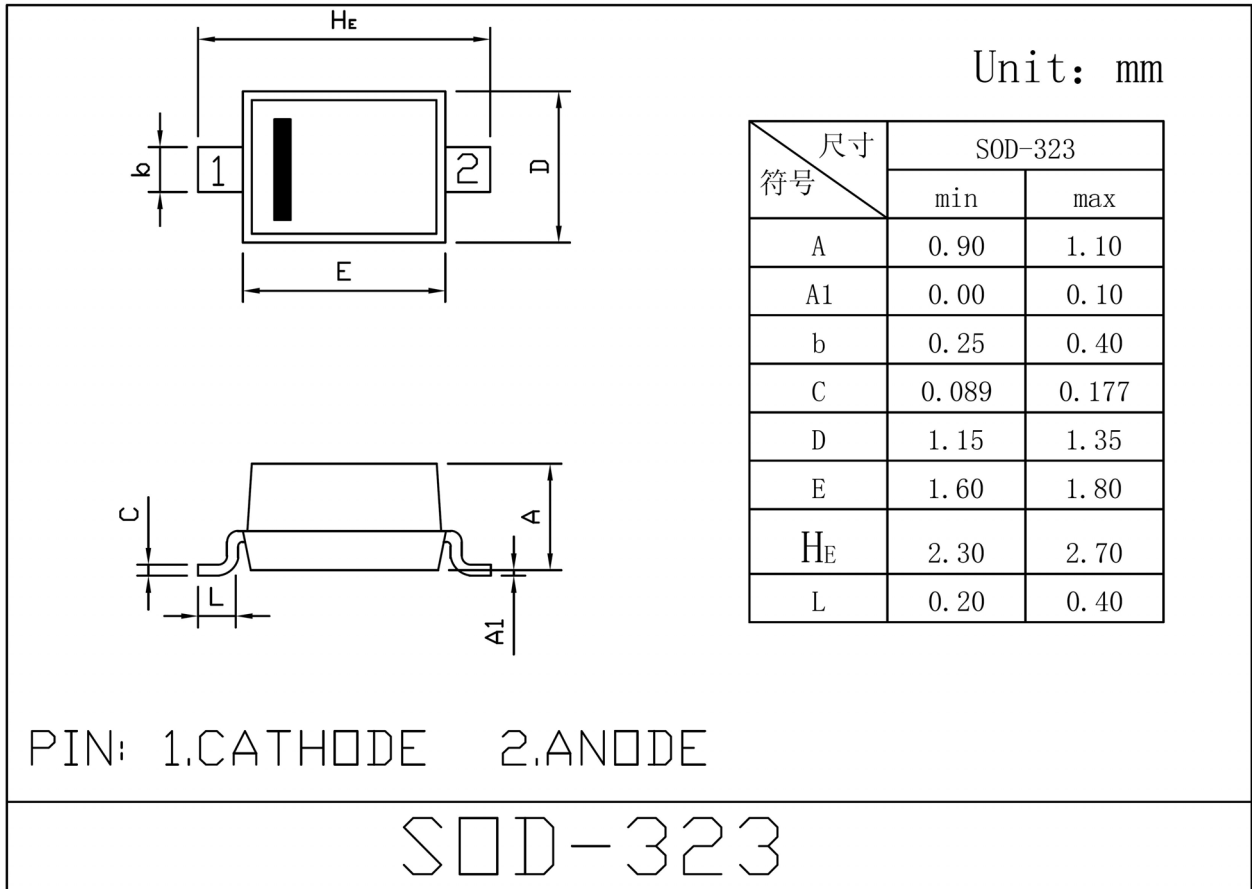

印章说明 / Marking Instructions

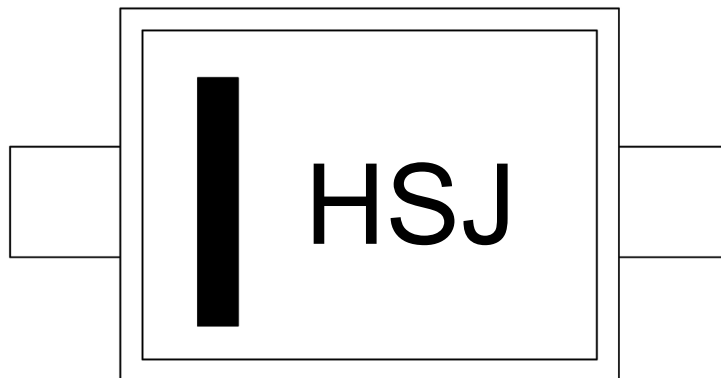

说明：

H： 为公司代码

SJ： 为型号代码

Note:

H: Company Code.

SJ: Product Type.

回流焊温度曲线图(无铅) / Temperature Profile for IR Reflow Soldering(Pb-Free)



说明：

- 1、预热温度 25 ~ 150°C，时间 60 ~ 90sec;
- 2、峰值温度 245±5°C，时间持续为 5±0.5sec;
- 3、焊接制程冷却速度为 2 ~ 10°C/sec.

Note:

- 1.Preheating:25~150°C, Time:60~90sec.
- 2.Peak Temp.:245±5°C, Duration:5±0.5sec.
3. Cooling Speed: 2~10°C/sec.

耐焊接热试验条件 / Resistance to Soldering Heat Test Conditions

温度：260±5°C

时间：10±1 sec.

Temp.:260±5°C

Time:10±1 sec

包装规格 / Packaging SPEC.

卷盘包装 / REEL

Package Type 封装形式	Units 包装数量					Dimension 包装尺寸 (unit: mm ³)		
	Units/Reel 只/卷盘	Reels/Inner Box 卷盘/盒	Units/Inner Box 只/盒	Inner Boxes/Outer Box 盒/箱	Units/Outer Box 只/箱	Reel	Inner Box 盒	Outer Box 箱
SOD-323	3,000	10	30,000	8	240,000	7" ×8	180×120×180	385×257×392

使用说明 / Notices