

Interface driver for microcomputer peripheral and display devices

BA13002F

The BA13002F is a high current transistor array consisting of six circuits of Darlington transistors. Because it incorporates built-in surge-absorbing diodes and base current-control resistors needed when using inductive loads such as relay coils, attachments can be kept to a minimum.

With an output withstanding voltage as high as 20V and an output current (sink current) of 320mA, this product is ideal for use with various drivers and as an interface with other elements.

●Applications

Drivers for LEDs, lamps, relays and solenoids

Interface with other elements

●Features

- 1) Output withstanding voltage (V_{CE0}) of 20V.
- 2) High output current (I_o) of 320mA (max.).
- 3) High current amplification factor (h_{FE}) of 1000 (min.).
- 4) Wide range of voltages (-25 to 20V) can be applied to input.
- 5) Equipped with output surge-absorbing clamp diode.
- 6) Equipped with strobe input pin.

●Absolute maximum ratings ($T_a=20^{\circ}\text{C}$ to $+75^{\circ}\text{C}$)

Parameter	Symbol	Limits	Unit
Power supply voltage	V_{CC}	10	V
Output withstanding voltage	V_{CE0}	-0.5~20	V
Output current	I_o	320	mA
Input voltage	V_i	-25~20	V
Strobe input voltage	V_i (STB)	20	V
Clamp diode reverse voltage	V_R (D)	20	V
Clamp diode forward current	I_F (D)	320	mA
Power dissipation ($T_a=25^{\circ}\text{C}$)	P_d	500 *1	mW
Operating temperature	T_{opr}	-20~75	$^{\circ}\text{C}$
Storage temperature	T_{stg}	-55~125	$^{\circ}\text{C}$

*1 Reduced by 5.0mW for each increase in T_a of 1°C over 25°C .
(when a 50 x 50 x 1.6 mm glass epoxy PCB is used).

●Block diagram

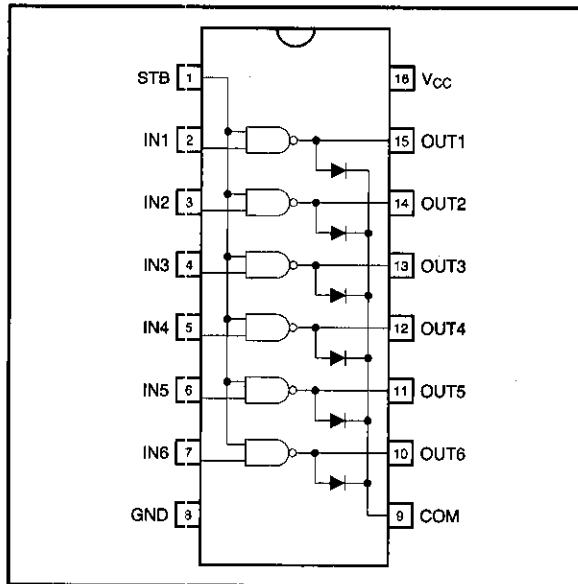

●Recommended operating conditions (Ta=-20°C to 75°C)

Parameter	Symbol	Min.	Typ.	Max.	Unit	Conditions
Power supply voltage	V _{CC}	3	—	8	V	
Output voltage	V _O	0	—	20	V	
Output current	I _O	0	—	300	mA	Duty cycle of 20 % or less: V _{CC} =6.5 V
		0	—	150	mA	Duty cycle of 40 % or less: V _{CC} =6.5 V
"H" input voltage (strobe)	V _{IH(STB)}	2.4	—	18	V	
"L" input voltage (strobe)	V _{IL(STB)}	0	—	0.2	V	
"H" input voltage	V _{IH}	3.2	—	18	V	I _O =300mA
"L" input voltage	V _{IL}	0	—	0.7	V	I _{O (leak)} =50 μA

● Internal circuit configuration diagram

BA13002F

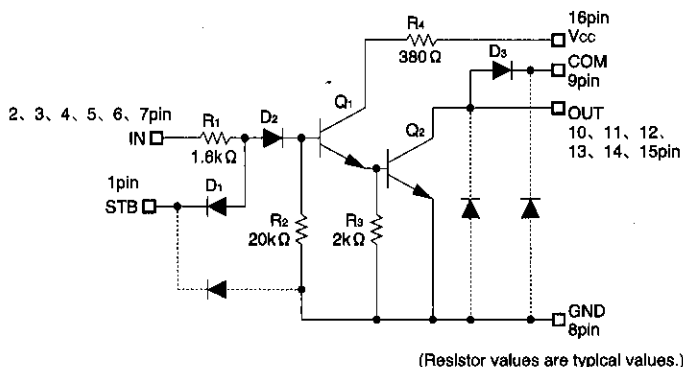

● Electrical characteristics (unless otherwise noted, $T_a = -25^\circ\text{C}$ to $+75^\circ\text{C}$)

Parameter	Symbol	Min.	Typ.	Max.	Unit	Conditions	Measurement Circuit	
Output withstanding voltage	V_{CE0}	20	—	—	V	$V_{CC}=8\text{V}$, $V_i=18\text{V}$, $V_{i(\text{STB})}=0.2\text{V}$, $I_{CE0}=100\ \mu\text{A}$	Fig.1	
Output saturation voltage	$V_{CE(\text{sat})}$	—	0.6	1.0	V	$V_i=7\text{V}$ $V_{i(\text{STB})}=2.4\text{V}$	Fig.2	
		—	0.5	0.85	V			$V_{CC}=6.5\text{V}$, $I_o=300\text{mA}$
		—	0.3	0.5	V			$V_{CC}=6.5\text{V}$, $I_o=250\text{mA}$ $V_{CC}=3\text{V}$, $I_o=120\text{mA}$
Clamp diode forward voltage	$V_{F(D)}$	—	1.4	2.4	V	$I_{F(D)}=320\text{mA}$	Fig.5	
Clamp diode reverse voltage	$V_{R(D)}$	20	40	—	V	$I_{R(D)}=100\ \mu\text{A}$	Fig.6	
Power supply current	I_{CC}	—	120	200	mA	$V_{CC}=8\text{V}$, $V_i=7\text{V}$ (all inputs), $V_{i(\text{STB})}=2.4\text{V}$	Fig.7	
DC current amplification factor	h_{FE}	1000	3000	—		$V_{CE}=4\text{V}$, $V_{CC}=6.5\text{V}$, $I_o=300\text{mA}$, $T_a=25^\circ\text{C}$	Fig.2	
Turn-on time	t_{ON}	—	0.1	—	μS	Refer to test circuit diagrams.	Fig.8	
Turn-off time	t_{OFF}	—	0.1	—	μS			
Input current	I_i	—	0.5	1.4	mA	$V_{CC}=8\text{V}$, $V_i=3.2\text{V}$, $V_{i(\text{STB})}=2.4\text{V}$	Fig.3	
Input reverse current	I_R	—	—	-20	μA			$V_{CC}=8\text{V}$, $V_i=-25\text{V}$
Strobe input current	$I_{i(\text{STB})}$	—	-7.9	—	mA	$V_{CC}=8\text{V}$, $V_i=3.2\text{V}$ (all inputs), $V_{i(\text{STB})}=0.2\text{V}$	Fig.4	
Strobe input reverse current	$I_{R(\text{STB})}$	—	—	20	μA			$V_{CC}=8\text{V}$, $V_i=0\text{V}$, $V_{i(\text{STB})}=20\text{V}$

Transistor arrays

● Measurement circuits

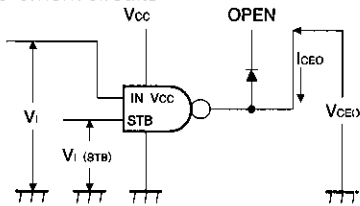

Fig.1 Output withstanding voltage V_{CE0}

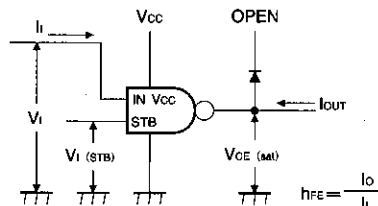

Fig.2 Output saturation voltage $V_{CE(sat)}$
DC current amplification factor h_{FE}

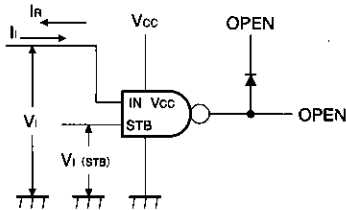

Fig.3 Input current I_i • Input reverse current I_R

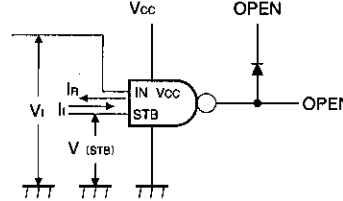

Fig.4 Strobe input current $I_{i(STB)}$ •
Strobe input reverse current $I_{R(STB)}$

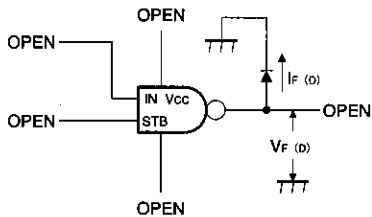

Fig.5 Clamp diode forward voltage $V_{F(D)}$

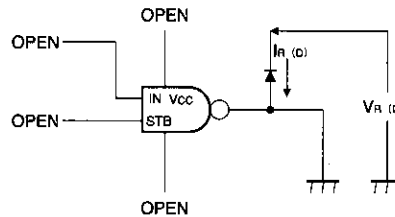

Fig.6 Clamp diode reverse voltage $V_{R(D)}$

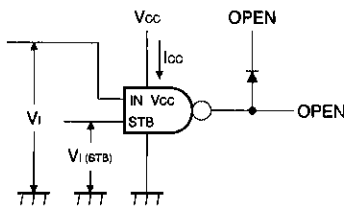

Fig.7 Power supply current I_{CC}

● Circuit operation

Input/output logic table

IN	STB	OUT
L	L	H
H	L	H
L	H	H
H	H	L

The driver operates based on the logic in the above table.

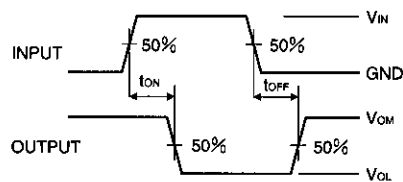
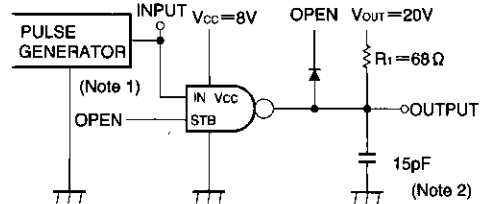
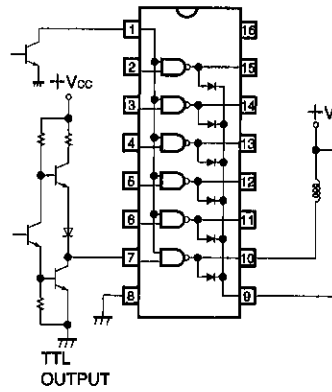

Fig.8 Turn-on time t_{ON}
Turn-off time t_{OFF}

(Note 1) Pulse width: $10 \mu s$, duty cycle $\leq 5\%$
(Note 2) Including probe capacitance

●Application example



BA13002F

●Operation notes

Make sure that the duty cycle – output current characteristic range is not exceeded.

●Thermal reduction curve

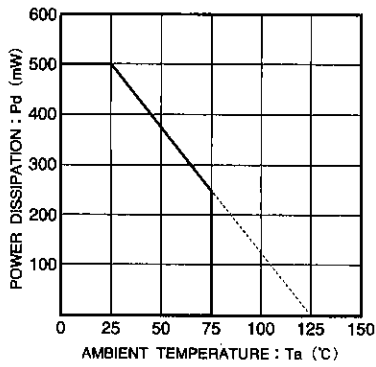

Fig.9 Thermal reduction curve

● Measurement data

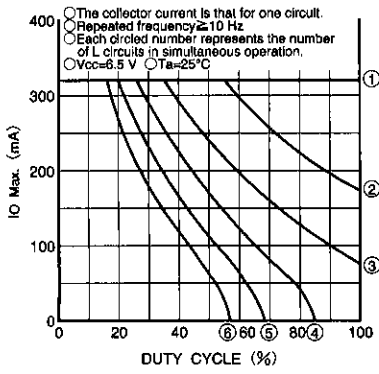

Fig.10 Duty cycle - collector current characteristics (I)

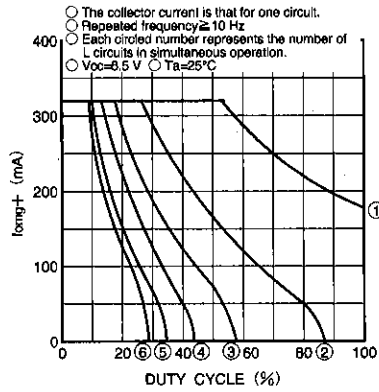

Fig.11 Duty cycle - collector current characteristics (II)

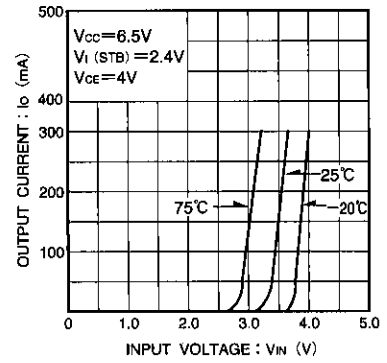

Fig.12 Output current - input voltage characteristics

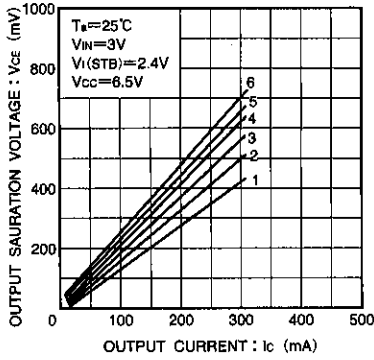

Fig.13 Output saturation voltage - output current characteristics

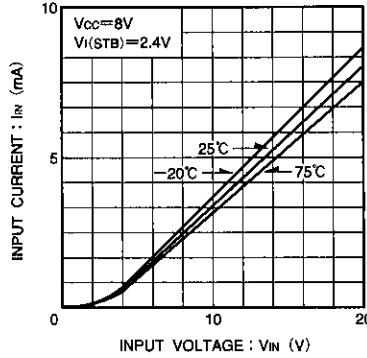

Fig.14 Input current - input voltage characteristics

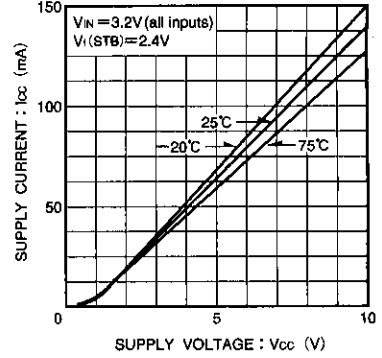

Fig.15 Power supply current - power supply voltage characteristics

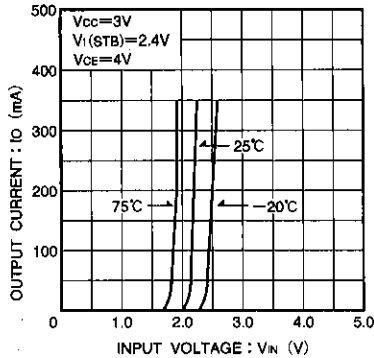

Fig.16 Output current - input voltage characteristics 1

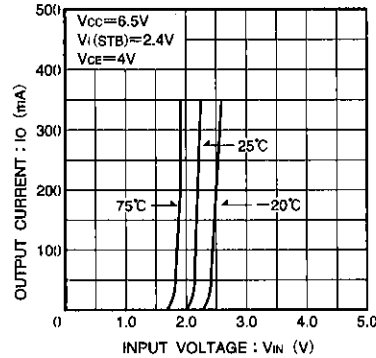

Fig.17 Output current - input voltage characteristics

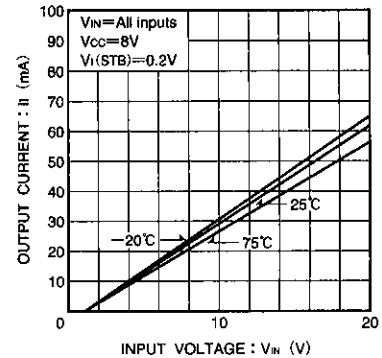

Fig.18 Input current - input voltage characteristics

● Measurement data

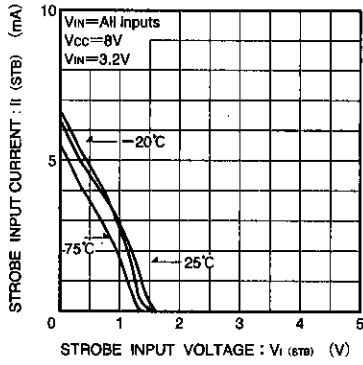

Fig.19 Strobe terminal input current - input voltage characteristics

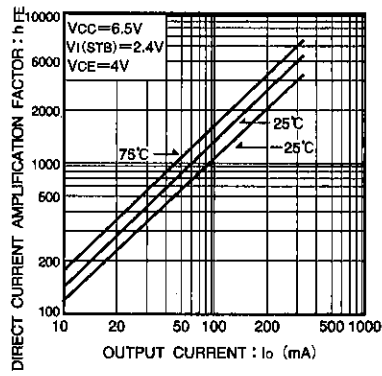
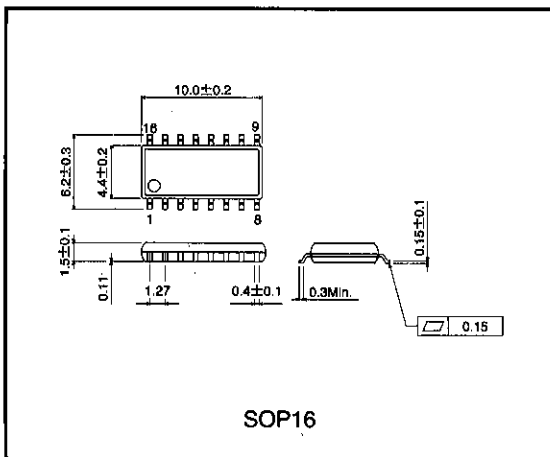

Fig.20 DC current amplification factor characteristics

● External dimensions (Units: mm)



Notes

- The contents described in this catalogue are correct as of March 1997.
- No unauthorized transmission or reproduction of this book, either in whole or in part, is permitted.
- The contents of this book are subject to change without notice. Always verify before use that the contents are the latest specifications. If, by any chance, a defect should arise in the equipment as a result of use without verification of the specifications, ROHM CO., LTD., can bear no responsibility whatsoever.
- Application circuit diagrams and circuit constants contained in this data book are shown as examples of standard use and operation. When designing for mass production, please pay careful attention to peripheral conditions.
- Any and all data, including, but not limited to application circuit diagrams, information, and various data, described in this catalogue are intended only as illustrations of such devices and not as the specifications for such devices. ROHM CO., LTD., disclaims any warranty that any use of such device shall be free from infringement of any third party's intellectual property rights or other proprietary rights, and further, assumes absolutely no liability in the event of any such infringement, or arising from or connected with or related to the use of such devices.
- Upon the sale of any such devices; other than for the buyer's right to use such devices itself, resell or otherwise dispose of the same; no express or implied right or license to practice or commercially exploit any intellectual property rights or other proprietary rights owned or controlled by ROHM CO., LTD., is granted to any such buyer.
- The products in this manual are manufactured with silicon as the main material.
- The products in this manual are not of radiation resistant design.

The products listed in this catalogue are designed to be used with ordinary electronic equipment or devices (such as audio-visual equipment, office-automation equipment, communications devices, electrical appliances, and electronic toys). Should you intend to use these products with equipment or devices which require an extremely high level of reliability and the malfunction of which would directly endanger human life (such as medical instruments, transportation equipment, aerospace machinery, nuclear-reactor controllers, fuel controllers, or other safety devices) please be sure to consult with our sales representatives in advance.

- Notes when exporting
 - It is essential to obtain export permission when exporting any of the above products when it falls under the category of strategic material (or labor) as determined by foreign exchange or foreign trade control laws.
 - Please be sure to consult with our sales representatives to ascertain whether any product is classified as a strategic material.