



**PROPRIETARY NOTE**  
THIS SPECIFICATION IS THE PROPERTY OF BOE HF AND SHALL NOT BE REPRODUCED OR COPIED WITHOUT THE WRITTEN PERMISSION OF BOE HF AND MUST BE RETURNED TO BOE HF UPON ITS REQUEST

SPEC. NUMBER	PRODUCT GROUP	Rev.	ISSUE DATE	PAGE
	TFT-LCD	P0	2012.2.6	1 OF 36

**BA101WS1-100**  
**Preliminary Product Specification P0**

[www.jxlcd.com](http://www.jxlcd.com)

HEFEI BOE OPTOELECTRONICS TECHNOLOGY





京东方  
BOE

PRODUCT GROUP

REV

ISSUE DATE

TFT- LCD PRODUCT

P0

2012.2.6

SPEC. NUMBER

SPEC. TITLE

BA101WS1-100 Preliminary Product Specification

PAGE

3 OF 36

## Contents

No.	Item	Page
1.0	General Description	4
2.0	Absolute Maximum Ratings	6
3.0	Electrical Specifications	7
4.0	Optical Specifications	10
5.0	Interface Connection	15
6.0	Signal Timing Specification	19
7.0	Signal Timing waveforms	21
8.0	Input Signals, Display Colors & Gray Scale of Colors	23
9.0	Power Sequence	24
10.0	Connector description	25
11.0	Mechanical Characteristics	26
12.0	Reliability Test	27
13.0	Handling & Cautions.	27
14.0	Label	28
15.0	Packing information	30
16.0	Mechanical Outline Dimension	31
17.0	EDID Table	33

 <b>京东方</b> <b>BOE</b>	<b>PRODUCT GROUP</b>	REV	ISSUE DATE
	TFT- LCD PRODUCT	P0	2012.2.6
SPEC. NUMBER	SPEC. TITLE BA101WS1-100 Preliminary Product Specification		PAGE 4 OF 36

## 1.0 GENERAL DESCRIPTION

### 1.1 Introduction

BA101WS1-100 is a color active matrix TFT LCD module using amorphous silicon TFT's (Thin Film Transistors) as an active switching devices. This module has a 10.1 inch diagonally measured active area with HD resolutions (1024horizontal by 600vertical pixel array). Each pixel is divided into RED, GREEN, BLUE dots which are arranged in vertical Stripe and this module can display 262,144 colors. The TFT-LCD panel used for this module is a low reflection and higher color type. Therefore, this module is suitable for Notebook PC. The LED Driver for back-light driving is built in this model. All input signals are LVDS interface compatible.

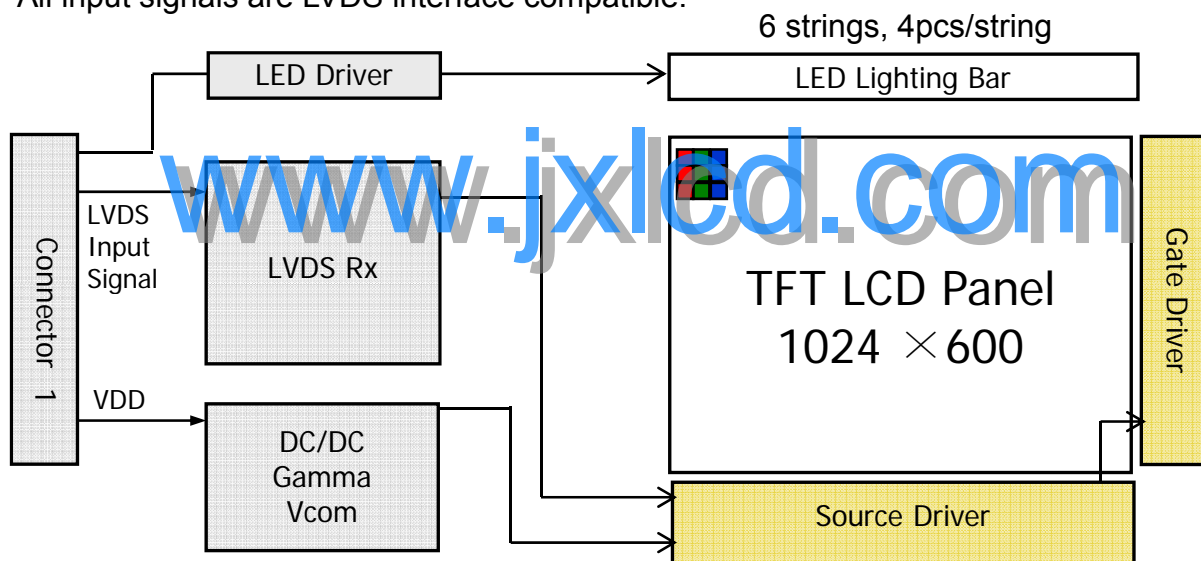

### 1.2 Features

- 1 Channel LVDS Interface with 1 pixel / clock
- Thin and light weight
- 6-bit color depth, display 262K colors
- Single LED Lighting Bar. (Up side/Horizontal Direction)
- Data enable signal mode
- Side Mounting Frame
- Green Product (RoHS & Halogen free product)
- On board LED Driving circuit
- Low driving voltage and low power consumption
- On board EDID chip



京东方  
BOE

PRODUCT GROUP

REV

ISSUE DATE

TFT- LCD PRODUCT

P0

2012.2.6

SPEC. NUMBER

SPEC. TITLE

BA101WS1-100 Preliminary Product Specification

PAGE

5 OF 36

1.3 Application

- Notebook PC (Wide type)

1.4 General Specification

The followings are general specifications at the model BA101WS1-100. (listed in Table 1.)

<Table 1. General Specifications>

Parameter	Specification	Unit	Remarks
Active area	222.72(H) × 125.28(V)	mm	
Number of pixels	1024 (H) × 600 (V)	pixels	
Pixel pitch	0.2175 (H) × 0.2088 (V)	mm	
Pixel arrangement	RGB Vertical stripe		
Display colors	262K	colors	
Display mode	Normally White		
Dimensional outline	245±0.5 (H) × 146.5±0.5 (V) × 3.6 (D:max)	mm	
Weight	170(max)	g	
Surface treatment	Glare / Hardness 3H		
Back-light	Up edge side, 1-LED Lighting Bar type		
Power consumption	P <sub>D</sub> : 0.8(max)	W	
	P <sub>BL</sub> : 1.8(max)	W	
	P <sub>total</sub> : 2.6(max)	W	



**PRODUCT GROUP**

REV

ISSUE DATE

TFT- LCD PRODUCT

P0

2012.2.6

SPEC. NUMBER

SPEC. TITLE

BA101WS1-100 Preliminary Product Specification

PAGE

6 OF 36

**2.0 ABSOLUTE MAXIMUM RATINGS**

The followings are maximum values which, if exceed, may cause faulty operation or damage to the unit. The operational and non-operational maximum voltage and current values are listed in Table 2.

< Table 2. Absolute Maximum Ratings >

Ta=25+/-2°C

Parameter	Symbol	Min.	Max.	Unit	Remarks
Power Supply Voltage	V <sub>DD</sub>	-0.3	4.0	V	Note 1
Logic Supply Voltage	V <sub>BL</sub>	4.5	16	V	
Operating Temperature	T <sub>OP</sub>	0	+50	°C	Note 2
Storage Temperature	T <sub>ST</sub>	-20	+60	°C	

- Notes : 1. Permanent damage to the device may occur if maximum values are exceeded functional operation should be restricted to the condition described under normal operating conditions.
2. Temperature and relative humidity range are shown in the figure below.  
 95 % RH Max. ( 40 °C ≥ Ta)  
 Maximum wet - bulb temperature at 39 °C or less. (Ta > 40 °C) No condensation.

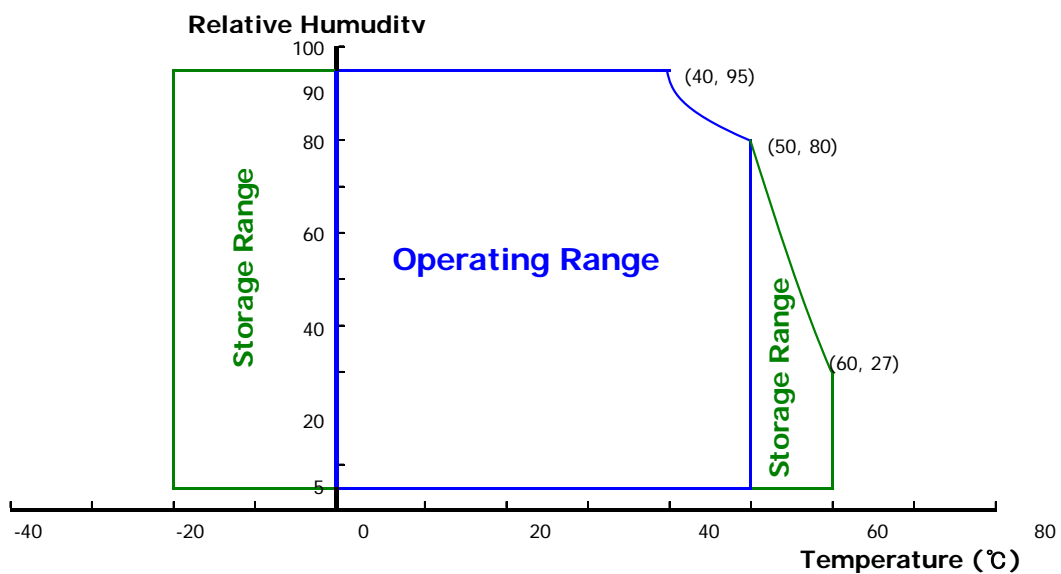



# PRODUCT GROUP

REV

ISSUE DATE

TFT- LCD PRODUCT

P0

2012.2.6

SPEC. NUMBER

SPEC. TITLE

BA101WS1-100 Preliminary Product Specification

PAGE

7 OF 36

## 3.0 ELECTRICAL SPECIFICATIONS

### 3.1 Electrical Specifications

< Table 3. Electrical specifications >

Ta=25+/-2°C

Parameter		Min.	Typ.	Max.	Unit	Remarks
Power Supply Voltage	V <sub>DD</sub>	3.0	3.3	3.6	V	Note 1
Permissible Input Ripple Voltage	V <sub>RF</sub>	-	-	100	mV	At V <sub>DD</sub> = 3.3V
In-rush Current	I <sub>RUSH</sub>	-	-	1.0	A	
Power Supply Current	I <sub>DD</sub>	-	200	240	mA	Note 1
Positive-going Input Threshold Voltage	V <sub>IT+</sub>	-	-	100	mV	V <sub>cm</sub> = 1.2V typ.
Negative-going Input Threshold Voltage	V <sub>IT-</sub>	-100	-	-	mV	
Differential Input Voltage	V <sub>ID</sub>	100	-	600	mV	
Power Consumption	P <sub>D</sub>	-	0.66	0.8	W	Note 1
	P <sub>BL</sub>	-	1.73	1.8	W	Note 2
	P <sub>total</sub>	-	2.39	2.6	W	

Notes : 1. The supply voltage is measured and specified at the interface connector of LCM.  
The current draw and power consumption specified is for 3.3V at 25°C.

- a) Typ : Check Flag
- b) Max : 2H1V Pixel pattern

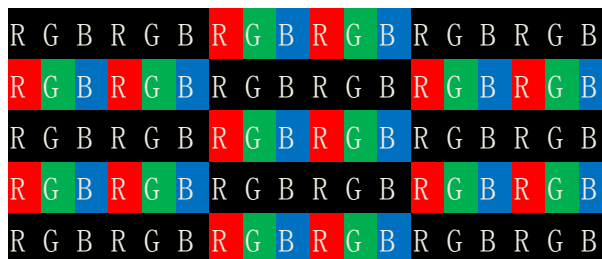

2. Calculated value for reference (P<sub>LED</sub> / LED driver efficiency(0.9))



# PRODUCT GROUP

REV

ISSUE DATE

TFT- LCD PRODUCT

P0

2012.2.6

SPEC. NUMBER

SPEC. TITLE

BA101WS1-100 Preliminary Product Specification

PAGE

8 OF 36

## 3.0 ELECTRICAL SPECIFICATIONS

### 3.2 Backlight Unit

< Table 4. LED Driving guideline specifications >

Ta=25+/-2°C

Parameter	Symbol	Condition	Values			Unit	Notes
			Min.	Typ.	Max.		
Input Voltage	VBL		4.5	5	16	V	
Input Current	IBL	V <sub>DIM</sub> =3.3V	-	500	-	A	1
Rush current	IRUSH	VBL= 5V	-	-	1	A	
Power Consumption	PBL	Typ Luminance	-	2	-	Watt	
PWM Frequency	F <sub>PWM</sub>		5	-	100	KHz	
PWM Level	High Level		2	3.3	4	V	
	Low Level		0	-	0.4	V	
PWM Duty	D <sub>PWM</sub>		1	-	100	%	2
Life Time			30,000	-	-	Hrs	3

Notes : 1. Calculator Value for reference  $IF \times VF \times 24 = P_{LED}$

2. The LED Life-time define as the estimated time to 50% degradation of initial luminance.

3. The life time of LED, 30,000Hrs, is determined as the time at which luminance of the LED is 50% compared to that of initial value at the typical LED current on condition of continuous operating at  $25 \pm 2^\circ C$ .





PRODUCT GROUP

REV

ISSUE DATE

TFT- LCD PRODUCT

P0

2012.2.6

SPEC. NUMBER

SPEC. TITLE

BA101WS1-100 Preliminary Product Specification

PAGE

9 OF 36

### 3.3 LED structure

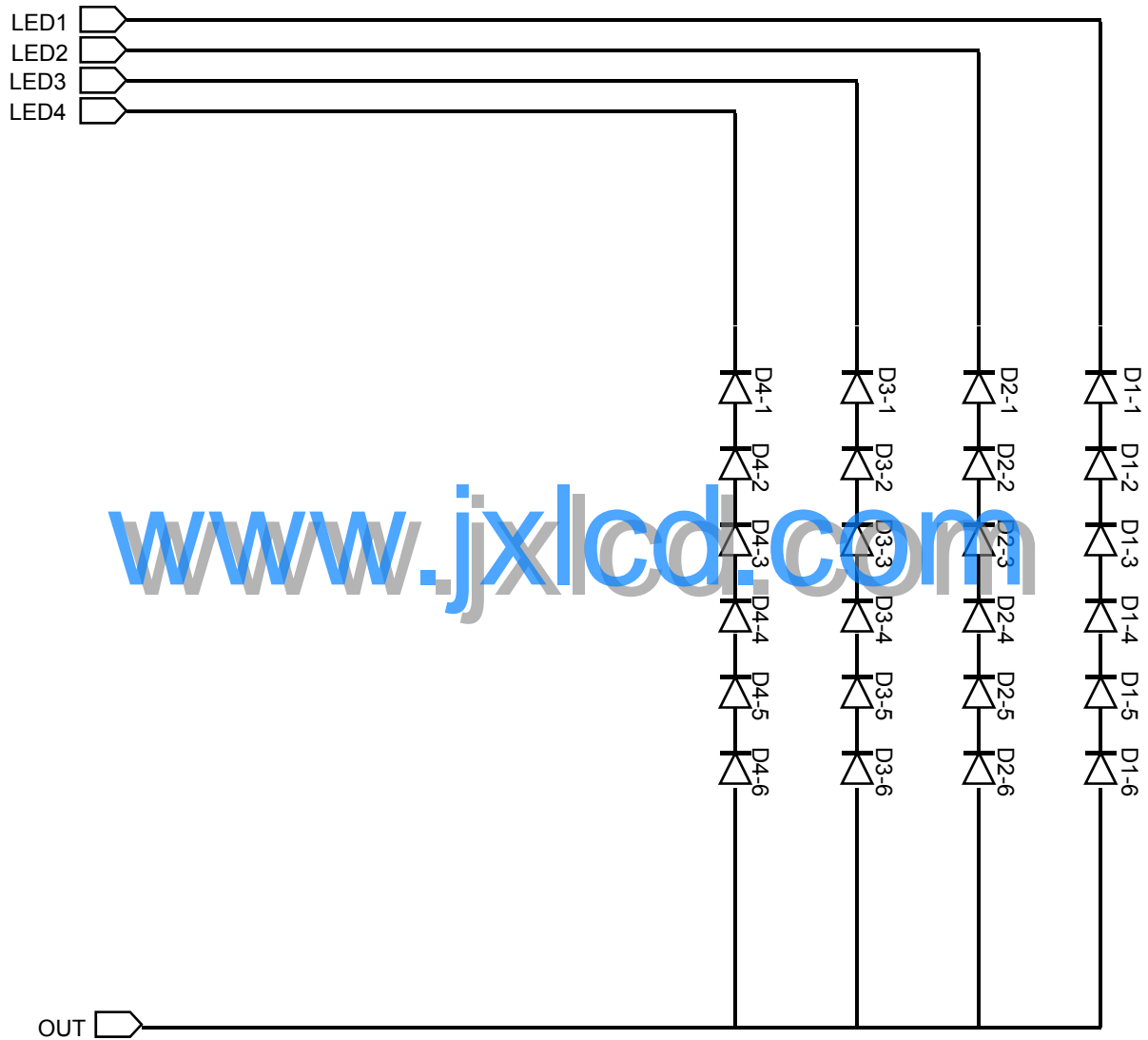

www.jxlcd.com



# PRODUCT GROUP

REV

ISSUE DATE

TFT- LCD PRODUCT

P0

2012.2.6

SPEC. NUMBER

SPEC. TITLE

BA101WS1-100 Preliminary Product Specification

PAGE

10 OF 36

## 4.0 OPTICAL SPECIFICATION

### 4.1 Overview

The test of Optical specifications shall be measured in a dark room (ambient luminance  $\leq 1$  lux and temperature =  $25 \pm 2^\circ\text{C}$ ) with the equipment of Luminance meter system (Goniometer system and TOPCON BM-5) and test unit shall be located at an approximate distance 50cm from the LCD surface at a viewing angle of  $\theta$  and  $\Phi$  equal to  $0^\circ$ . We refer to  $\theta_{\theta=0}$  ( $=\theta_3$ ) as the 3 o'clock direction (the "right"),  $\theta_{\theta=90}$  ( $=\theta_{12}$ ) as the 12 o'clock direction ("upward"),  $\theta_{\theta=180}$  ( $=\theta_9$ ) as the 9 o'clock direction ("left") and  $\theta_{\theta=270}$  ( $=\theta_6$ ) as the 6 o'clock direction ("bottom"). While scanning  $\theta$  and/or  $\Phi$ , the center of the measuring spot on the Display surface shall stay fixed. The measurement shall be executed after 30 minutes warm-up period. VDD shall be 12.0V +/-10% at  $25^\circ\text{C}$ . Optimum viewing angle direction is 6 o'clock.

### 4.2 Optical Specifications

<Table 5. Optical Specifications>

Parameter		Symbol	Condition	Min	Typ	Max	Unit	Remark
Viewing Angle	Horizontal	$\theta_3$	CR > 10	-	45	-	Deg.	Note 1
		$\theta_9$		-	45	-	Deg.	
	Vertical	$\theta_{12}$		-	15	-	Deg.	
		$\theta_6$		-	35	-	Deg.	
Color Temperature				-	-	-	K	
Color Gamut				-	45	-	%	NTSC
Contrast ratio		CR		-	500:1	-		Note 2
Luminance of White	5 Points	$Y_w$		170	200	-	cd/m <sup>2</sup>	Note 3
White luminance uniformity	5 Points	$\Delta Y_5$		80	-	-	%	Note 4
	13 Points	$\Delta Y_{13}$		63	-	-	%	
Reproduction of color	White	$W_x$	$\theta = 0^\circ$ (Center) Normal Viewing Angle	TYP. - 0.3	0.313	TYP. + 0.3		Note 5
		$W_y$			0.329			
	Red	$R_x$			0.592			
		$R_y$			0.346			
	Green	$G_x$			0.329			
		$G_y$			0.542			
	Blue	$B_x$			0.149			
		$B_y$			0.145			
Response Time		$T_g$		-	8	25	ms	Note 6
Gamma Scale				2.0	2.2	2.4		

 <b>京东方</b> <b>BOE</b>	<b>PRODUCT GROUP</b>	REV	ISSUE DATE
	TFT- LCD PRODUCT	P0	2012.2.6
SPEC. NUMBER	SPEC. TITLE BA101WS1-100 Preliminary Product Specification		PAGE 11 OF 36

**Note :**

1. Viewing angle is the angle at which the contrast ratio is greater than 10. The viewing are determined for the horizontal or 3, 9 o'clock direction and the vertical or 6, 12 o'clock direction with respect to the optical axis which is normal to the LCD surface.
2. Contrast measurements shall be made at viewing angle of  $\theta = 0^\circ$  and at the center of the LCD surface. Luminance shall be measured with all pixels in the view field set first to white, then to the dark (black) state. (See FIGURE 1 shown in Appendix) Luminance Contrast Ratio (CR) is defined mathematically.

$$\frac{\text{Luminance when displaying a white raster}}{\text{Luminance when displaying a black raster}}$$

3. Center Luminance of white is defined as the LCD surface. Luminance shall be measured with all pixels in the view field set first to white. This measurement shall be taken at the locations shown in FIGURE 2 for a total of the measurements per display.
4. The White luminance uniformity on LCD surface is then expressed as :
 
$$\Delta Y5 = (\text{Minimum Luminance of 5 points} / \text{Maximum Luminance of 5 points}) * 100$$

$$\Delta Y13 = (\text{Minimum Luminance of 13 points} / \text{Maximum Luminance of 13 points}) * 100$$
 (See FIGURE 2 and FIGURE 3 shown in Appendix).
5. The color chromaticity coordinates specified in Table 4. shall be calculated from the spectral data measured with all pixels first in red, green, blue and white. Measurements shall be made at the center of the panel.
6. The electro-optical response time measurements shall be made as FIGURE 4 shown in Appendix by switching the "data" input signal ON and OFF. The times needed for the luminance to change from 10% to 90% is Td, and 90% to 10% is Tr.

 <b>京东方</b> <b>BOE</b>	<b>PRODUCT GROUP</b>	REV	ISSUE DATE
	TFT- LCD PRODUCT	P0	2012.2.6
SPEC. NUMBER	SPEC. TITLE BA101WS1-100 Preliminary Product Specification		PAGE 12 OF 36

### 4.3 Optical measurements

**Figure 1. Measurement Set Up**

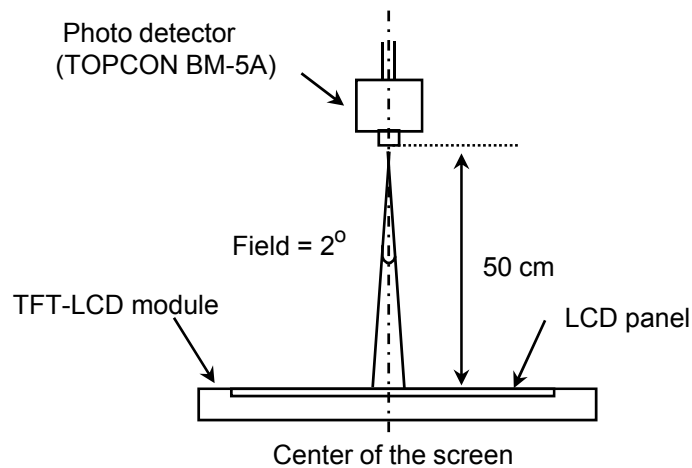

Optical characteristics measurement setup

**Figure 2. White Luminance and Uniformity Measurement Locations (5 points)**

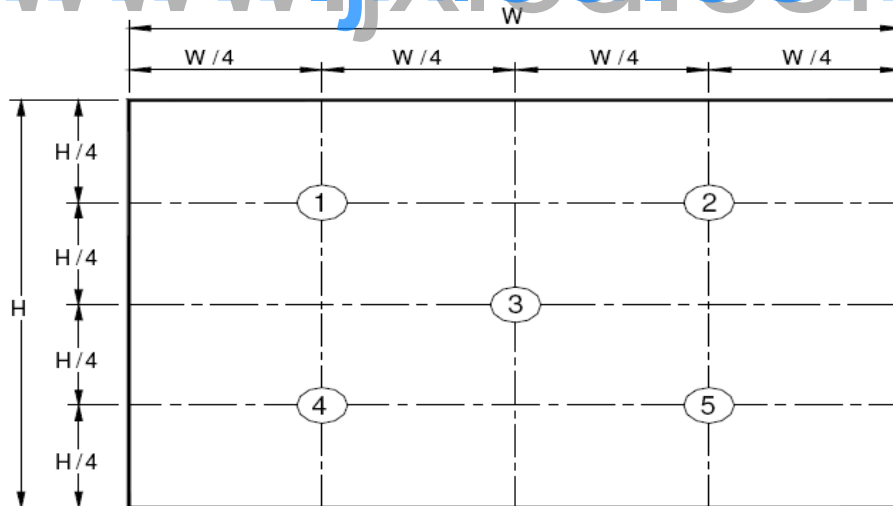

Center Luminance of white is defined as luminance values of center 5 points across the LCD surface. Luminance shall be measured with all pixels in the view field set first to white. This measurement shall be taken at the locations shown in FIGURE 2 for a total of the measurements per display.

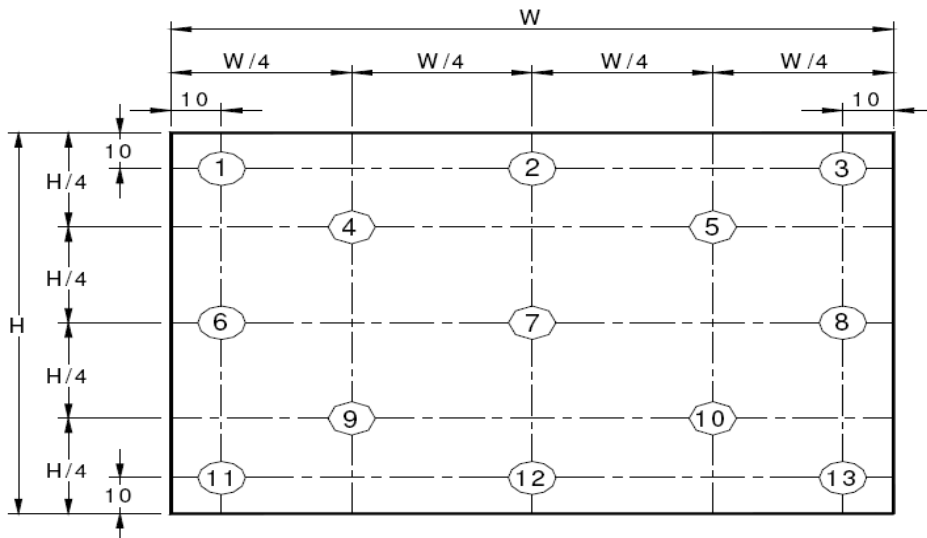
**Figure 3. Uniformity Measurement Locations (13 points)**

The White luminance uniformity on LCD surface is then expressed as :  $\Delta Y_5 = \text{Minimum Luminance of five points} / \text{Maximum Luminance of five points}$  (see FIGURE 2).  $\Delta Y_{13} = \text{Minimum Luminance of 13 points} / \text{Maximum Luminance of 13 points}$  (see FIGURE 3).

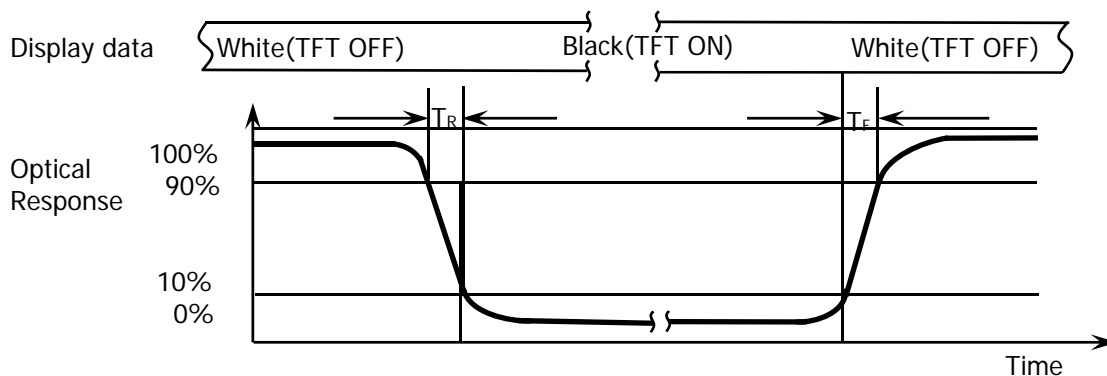
**Figure 4. Response Time Testing**

The electro-optical response time measurements shall be made as shown in FIGURE 4 by switching the “data” input signal ON and OFF. The times needed for the luminance to change from 10% to 90% is  $T_d$  and 90% to 10% is  $T_r$ .

 <b>京东方</b> <b>BOE</b>	<b>PRODUCT GROUP</b>	REV	ISSUE DATE
	TFT- LCD PRODUCT	P0	2012.2.6
SPEC. NUMBER	SPEC. TITLE BA101WS1-100 Preliminary Product Specification		PAGE 14 OF 36

**Figure 5. Cross Modulation Test Description**

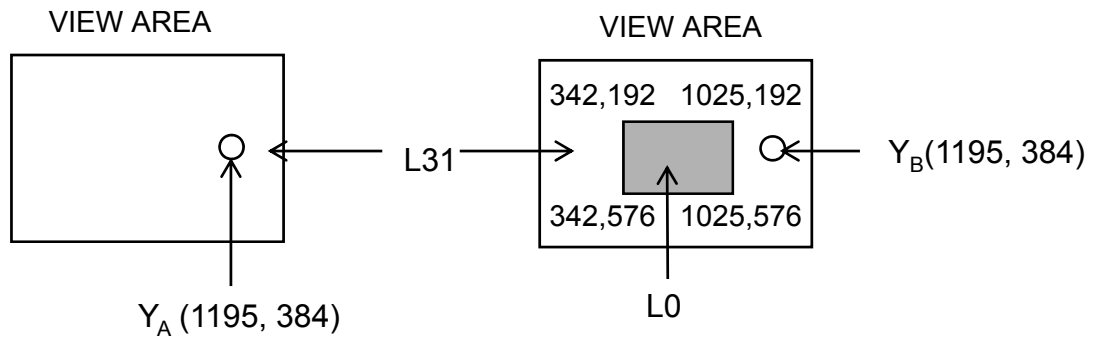

$$\text{Cross-Talk (\%)} = \left| \frac{Y_B - Y_A}{Y_A} \right| \times 100$$

Where:

$Y_A$  = Initial luminance of measured area (cd/m<sup>2</sup>)

$Y_B$  = Subsequent luminance of measured area (cd/m<sup>2</sup>)

The location measured will be exactly the same in both patterns.

Cross-Talk of one area of the LCD surface by another shall be measured by comparing the luminance ( $Y_A$ ) of a 25mm diameter area, with all display pixels set to a gray level, to the luminance ( $Y_B$ ) of that same area when any adjacent area is driven dark (Refer to FIGURE 5).



# PRODUCT GROUP

REV

ISSUE DATE

TFT- LCD PRODUCT

P0

2012.2.6

SPEC. NUMBER

SPEC. TITLE

BA101WS1-100 Preliminary Product Specification

PAGE

15 OF 36

## 5.0 INTERFACE CONNECTION.

### 5.1 Electrical Interface Connection

The electronics interface connector is STM MSAK24025P40G. The connector interface pin assignments are listed in Table 6.

<Table 6. Pin Assignments for the Interface Connector>

Terminal	Symbol	Functions
Pin No.	Symbol	Description
1	NC	No connect
2	VDD	Power Supply +3.3V
3	VDD	Power Supply +3.3V
4	VEDID	EDID +3.3V Power
5	NC	No Connect
6	CLK EDID	EDID Clock Input
7	DATA EDID	EDID Data Input
8	Rx0IN0-	-LVDS Differential Data (Odd R0-R5, G0)
9	Rx0IN0+	+LVDS Differential Data (Odd R0-R5, G0)
10	VSS	Ground
11	Rx0IN1-	-LVDS Differential Data (Odd G1-G5, B0-B1)
12	Rx0IN1+	+LVDS Differential Data (Odd G1-G5, B0-B1)
13	VSS	Ground
14	Rx0IN2-	-LVDS Differential Data (Odd B2-B5, HS, VS, DE)
15	Rx0IN2+	+LVDS Differential Data (Odd B2-B5, HS, VS, DE)
16	VSS	Ground
17	Rx0CKIN-	-LVDS Odd Differential CLK
18	Rx0CKIN+	+LVDS Odd Differential CLK
19	VSS	Ground
20	NC	No Connect
21	NC	No Connect
22	VSS	Ground
23	NC	No Connect
24	NC	No Connect
25	VSS	Ground
26	NC	No Connect
27	NC	No Connect
28	VSS	Ground
29	NC	No Connect
30	NC	No Connect



京东方  
BOE

PRODUCT GROUP

REV

ISSUE DATE

TFT- LCD PRODUCT

P0

2012.2.6

SPEC. NUMBER

SPEC. TITLE

BA101WS1-100 Preliminary Product Specification

PAGE

16 OF 36

Terminal	Symbol	Functions
Pin No.	Symbol	Description
31	VLED GND	LED Ground
32	VLED GND	LED Ground
33	VLED GND	LED Ground
34	NC	No Connect
35	S PWMIN	System PWM signal Input
36	BL ON	LED enable pin (+3V input, +5V tolerance)
37	NC	No Connect
38	VLED	LED Power Supply 5V-21V
39	VLED	LED Power Supply 5V-21V
40	VLED	LED Power Supply 5V-21V

Note.1

-BIST="H (3.3V)" : Display BIST pattern @ No LVDS CLK or DE

(white->black->red->green->blue->white...)

-BIST="L(GND or NC)" : Display black pattern @ No LVDS CLK or DE





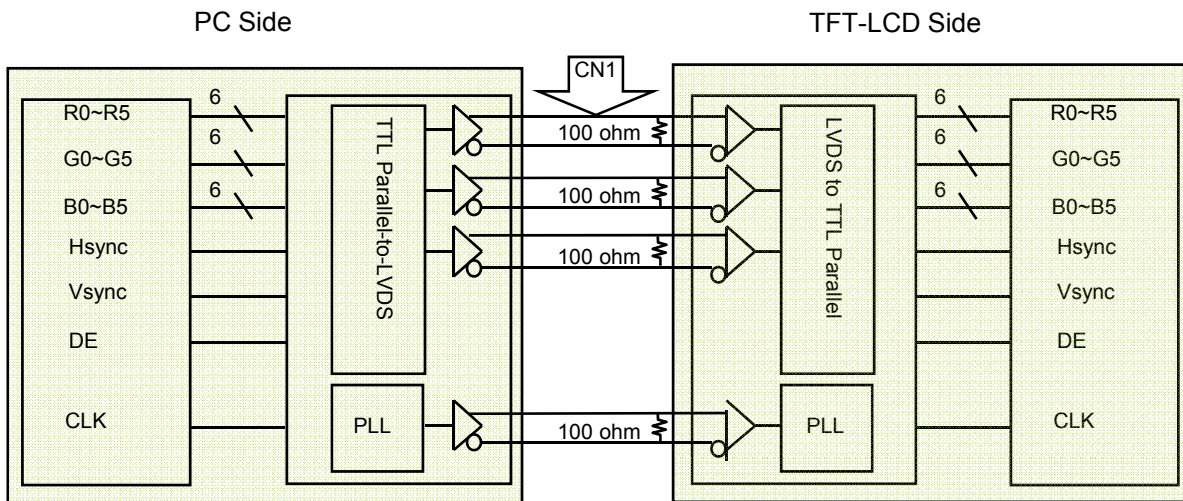

**5-2. LVDS Interface**

Note. Transmitter : Thine THC63LVDM63A or equivalent.

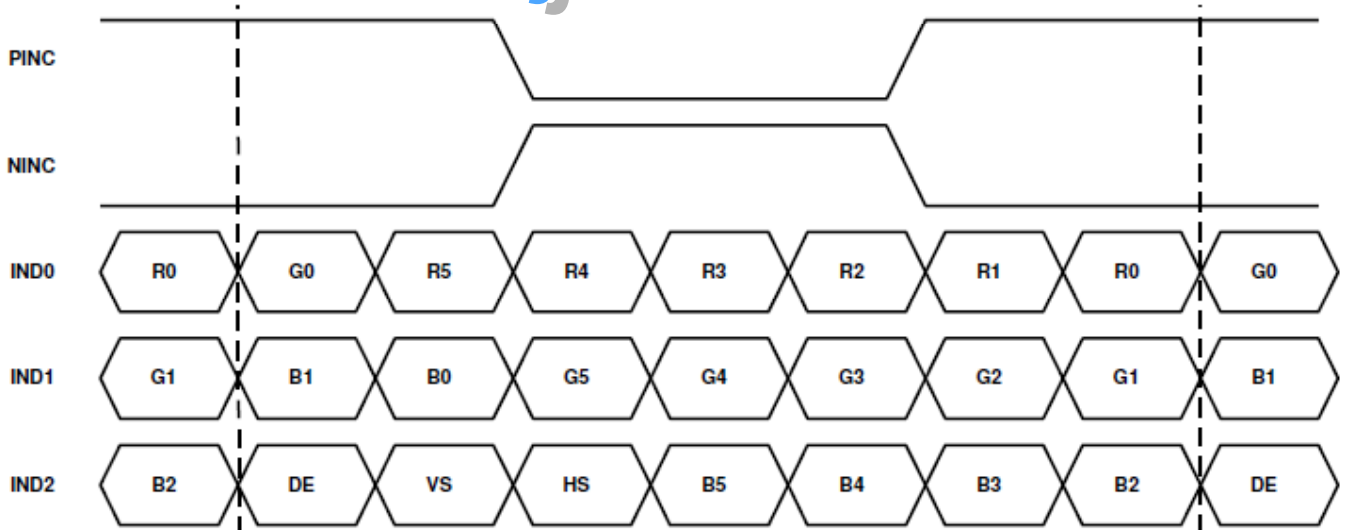
Transmitter is not contained in Module.

**5.3.LVDS Input signal**

Note. Pin connection in case of using Thine THC63LVDM63A

 <b>京东方</b> <b>BOE</b>	<b>PRODUCT GROUP</b>	REV	ISSUE DATE
	TFT- LCD PRODUCT	P0	2012.2.6
SPEC. NUMBER	SPEC. TITLE BA101WS1-100 Preliminary Product Specification		PAGE 18 OF 36

### 5.3 Data Input Format

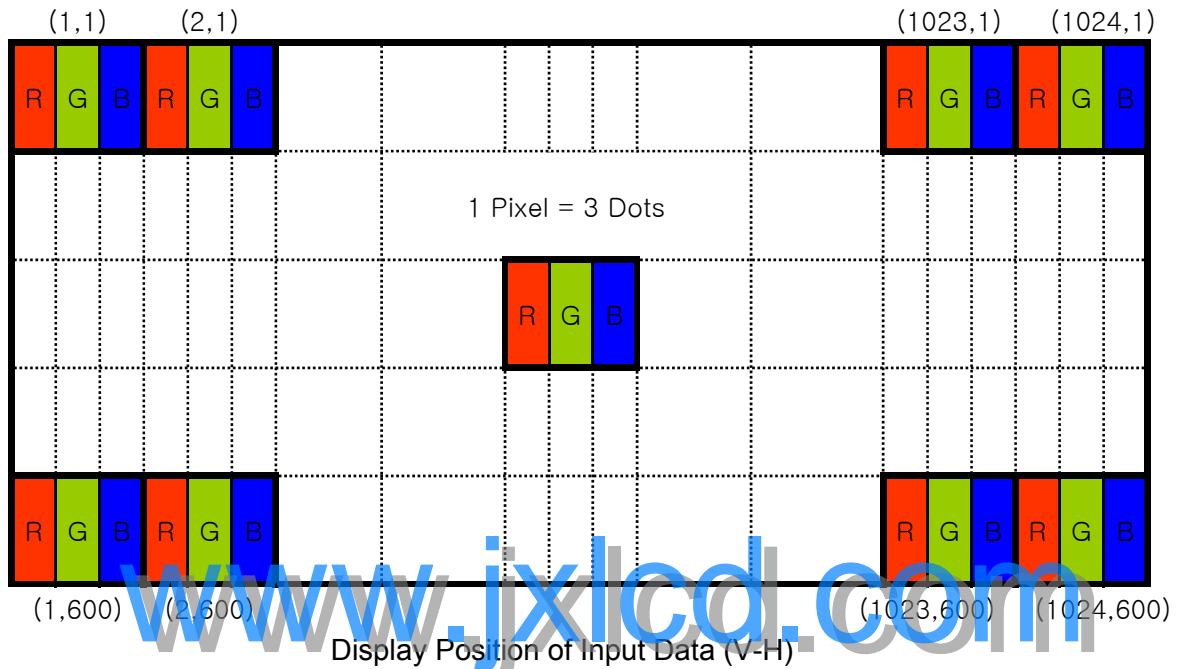

### 5.4 Back-light & LCM Interface Connection

Interface Connector: Two Hot Pad

 <b>京东方</b> <b>BOE</b>	<b>PRODUCT GROUP</b>	REV	ISSUE DATE
	TFT- LCD PRODUCT	P0	2012.2.6
SPEC. NUMBER	SPEC. TITLE BA101WS1-100 Preliminary Product Specification		PAGE 19 OF 36

## 6.0 SIGNAL TIMING SPECIFICATION

6.1 The BA101WS1-100 is operated by the DE only.

Item		Symbols	Min	Typ	Max	Unit
Clock	Frequency	1/Tc	40.8	51.2	67.2	MHz
	High Time	Tch	-	4/7	-	Tc
	Low Time	Tcl	-	3/7	-	Tc
Frame Period		Tv	610	635	800	lines
			-	60	-	Hz
			-	16.7	-	ms
Vertical Display Period		Tvd	600	600	600	lines
One line Scanning Period		Th	1114	1344	1400	clocks
Horizontal Display Period		Thd	1024	1024	1024	clocks



PRODUCT GROUP

REV

ISSUE DATE

TFT- LCD PRODUCT

P0

2012.2.6

SPEC. NUMBER

SPEC. TITLE

BA101WS1-100 Preliminary Product Specification

PAGE

20 OF 36

6.2 LVDS Rx Interface Timing Parameter

The specification of the LVDS Rx interface timing parameter is shown in Table 8.

Parameters	Symbols	Min	Typ	Max	Unit	Condition
Clock frequency	$R_{xFCLK}$	20	-	71	MHz	
Input data skew margin	$T_{RSKM}$	500	-	-	ps	$ V_{ID} =400mV$ $R_{xVCM}=1.2V$ $R_{xFCLK}=71MHz$
Clock high time	$T_{LVCH}$	-	$4/(7 * R_{xFCLK})$		ns	
Clock low time	$T_{LVCL}$		$3/(7 * R_{xFCLK})$		ns	
PLL wake-up time	$T_{enPLL}$			150	us	

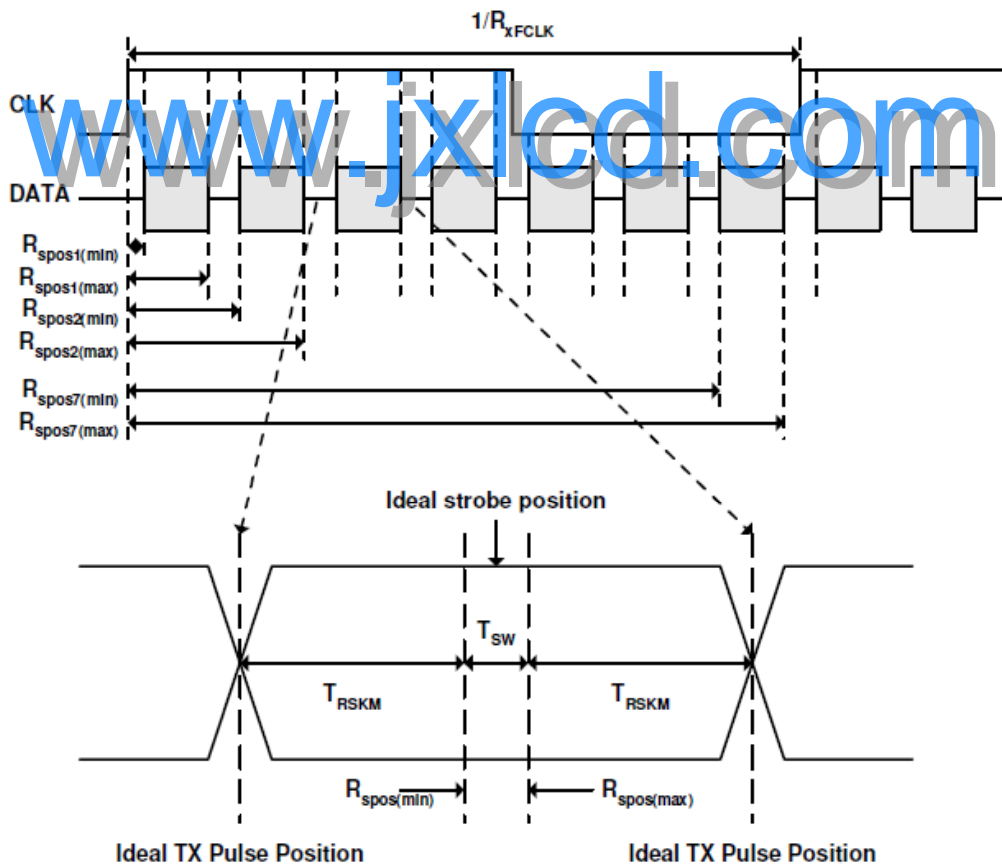

$T_{RSKM}$ : Receiver strobe margin  
 $R_{SPOS}$ : Receiver strobe position  
 $T_{SW}$ : Strobe width (Internal data sampling window)



PRODUCT GROUP

REV

ISSUE DATE

TFT- LCD PRODUCT

P0

2012.2.6

SPEC. NUMBER

SPEC. TITLE

PAGE

BA101WS1-100 Preliminary Product Specification

21 OF 36

7.0 SIGNAL TIMING WAVEFORMS OF INTERFACE SIGNAL

7.1 Vertical Timing Diagram DE (Dual Gate)

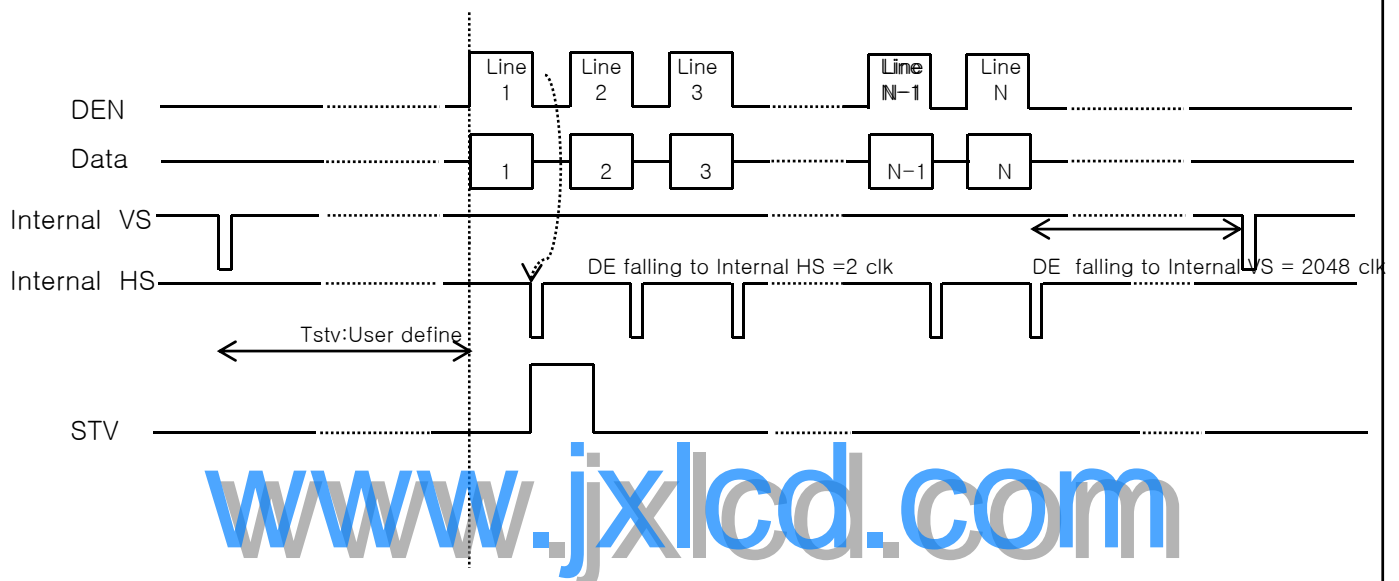

7.2 Gate output timing diagram (Dual Gate)

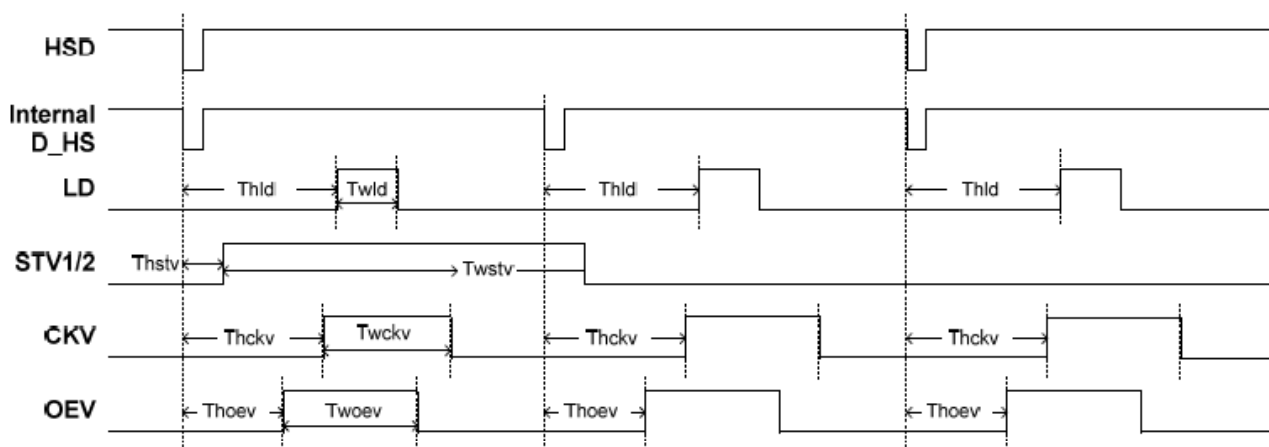



京东方  
BOE

PRODUCT GROUP

TFT- LCD PRODUCT

REV

P0

ISSUE DATE

2012.2.6

SPEC. NUMBER

SPEC. TITLE

BA101WS1-100 Preliminary Product Specification

PAGE

22 OF 36

7.3 Output Timing Table

Parameters	Symbols	Min	Typ	Max	Unit	Condition
DCLK Frequency	$F_{clk}$	-	65	71	MHz	VDD=2.3V~3.6V
DCLK Cycle Time	$T_{clk}$	14.1	15.4	-	ns	
DCLK Pulse Duty	$T_{cwh}$	40	50	60	%	Tclk
Time from HSD to Source Output	$T_{hso}$		64		DCLK	
Time from HSD to LD	$T_{hld}$		64	150	DCLK	
Time from HSD to STV	$T_{hstv}$		2		DCLK	
Time from HSD to CKV	$T_{hckv}$		20		DCLK	
Time from HSD to OEV	$T_{hoev}$		4		DCLK	
LD Pulse Width	$T_{wld}$		10		DCLK	
CKV Pulse Width	$T_{wckv}$		66		DCLK	
OEV Pulse Width	$T_{woev}$		74		DCLK	



# PRODUCT GROUP

REV

ISSUE DATE

TFT- LCD PRODUCT

P0

2012.2.6

SPEC. NUMBER

SPEC. TITLE

PAGE

BA101WS1-100 Preliminary Product Specification

23 OF 36

## 8.0 INPUT SIGNALS, BASIC DISPLAY COLORS & GRAY SCALE OF COLORS

	Colors & Gray scale	Data signal																	
		R0	R1	R2	R3	R4	R5	G0	G1	G2	G3	G4	G5	B0	B1	B2	B3	B4	B5
Basic colors	Black	0	0	0	0	0	0	0	0	0	0	0	0	0	0	0	0	0	0
	Blue	0	0	0	0	0	0	0	0	0	0	0	0	1	1	1	1	1	1
	Green	0	0	0	0	0	0	1	1	1	1	1	1	0	0	0	0	0	0
	Light Blue	0	0	0	0	0	0	1	1	1	1	1	1	1	1	1	1	1	1
	Red	1	1	1	1	1	1	0	0	0	0	0	0	0	0	0	0	0	0
	Purple	1	1	1	1	1	1	0	0	0	0	0	0	1	1	1	1	1	1
	Yellow	1	1	1	1	1	1	1	1	1	1	1	1	0	0	0	0	0	0
	White	1	1	1	1	1	1	1	1	1	1	1	1	1	1	1	1	1	1
Gray scale of Red	Black	0	0	0	0	0	0	0	0	0	0	0	0	0	0	0	0	0	0
	△ Darker	1	0	0	0	0	0	0	0	0	0	0	0	0	0	0	0	0	0
	△ ▽																		
	▽ Brighter	1	0	1	1	1	1	0	0	0	0	0	0	0	0	0	0	0	0
	▽	0	1	1	1	1	1	0	0	0	0	0	0	0	0	0	0	0	0
	Red	1	1	1	1	1	1	0	0	0	0	0	0	0	0	0	0	0	0
Gray scale of Green	Black	0	0	0	0	0	0	0	0	0	0	0	0	0	0	0	0	0	0
	△ Darker	0	0	0	0	0	0	1	0	0	0	0	0	0	0	0	0	0	0
	△ ▽																		
	▽ Brighter	0	0	0	0	0	0	1	0	1	1	1	1	0	0	0	0	0	0
	▽	0	0	0	0	0	0	0	1	1	1	1	1	0	0	0	0	0	0
	Green	0	0	0	0	0	0	1	1	1	1	1	1	0	0	0	0	0	0
Gray scale of Blue	Black	0	0	0	0	0	0	0	0	0	0	0	0	0	0	0	0	0	0
	△ Darker	0	0	0	0	0	0	0	0	0	0	0	0	1	0	0	0	0	0
	△ ▽																		
	▽ Brighter	0	0	0	0	0	0	0	0	0	0	0	0	1	0	1	1	1	1
	▽	0	0	0	0	0	0	0	0	0	0	0	0	0	1	1	1	1	1
	Blue	0	0	0	0	0	0	0	0	0	0	0	0	1	1	1	1	1	1
Gray scale of White & Black	Black	0	0	0	0	0	0	0	0	0	0	0	0	0	0	0	0	0	0
	△ Darker	1	0	0	0	0	0	1	0	0	0	0	0	1	0	0	0	0	0
	△ ▽																		
	▽ Brighter	1	0	1	1	1	1	1	0	1	1	1	1	1	0	1	1	1	1
	▽	0	1	1	1	1	1	0	1	1	1	1	1	0	1	1	1	1	1
	White	1	1	1	1	1	1	1	1	1	1	1	1	1	1	1	1	1	1

## 9.0 POWER SEQUENCE

To prevent a latch-up or DC operation of the LCD module, the power on/off sequence shall be as shown in below

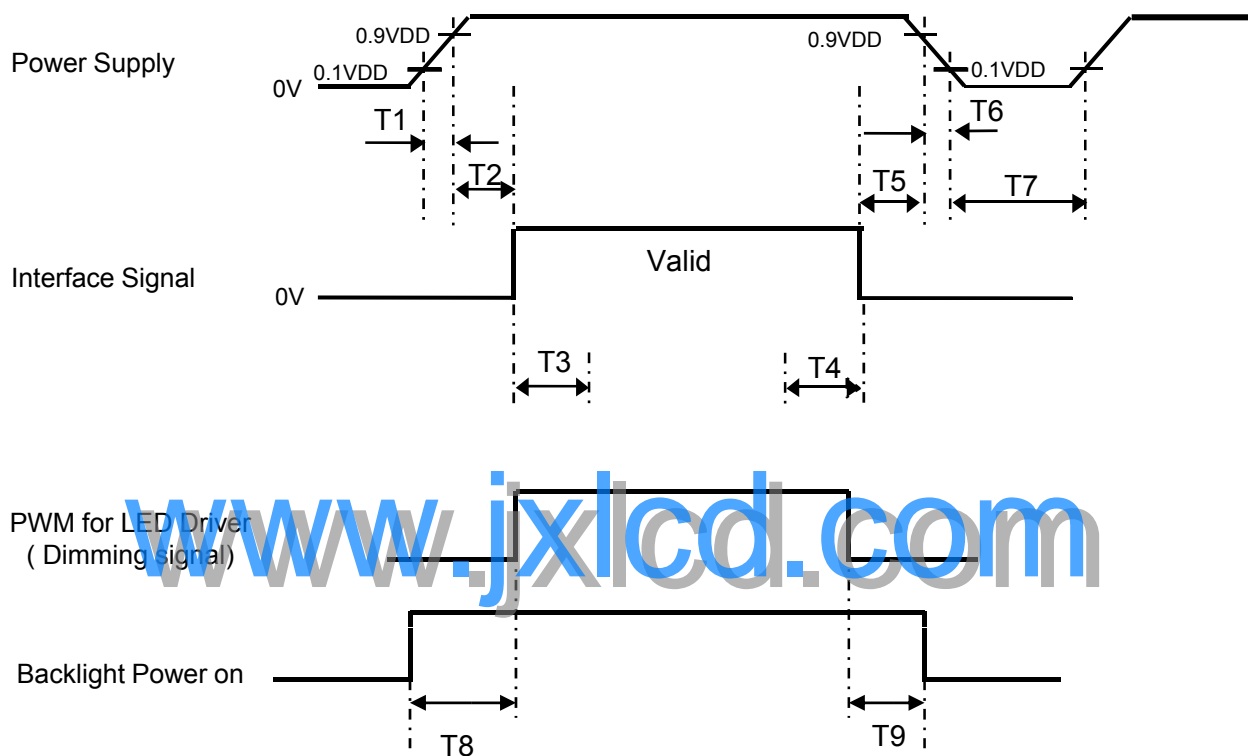

- $0.5\text{ms} \leq T1 \leq 10\text{ms}$
- $0\text{ms} \leq T2 \leq 50\text{ms}$
- $200\text{ms} \leq T3$
- $0\text{ms} \leq T4$
- $0\text{ms} \leq T5$

- $0\text{ms} \leq T6 \leq 10\text{ms}$
- $150\text{ms} \leq T7$
- $0\text{ms} \leq T8$
- $0\text{ms} \leq T9$

### Notes:

1. When the power supply VDD is 0V, keep the level of input signals on the low or keep high impedance.
2. Do not keep the interface signal high impedance when power is on. Back Light must be turn on after power for logic and interface signal are valid.



 <b>京东方</b> <b>BOE</b>	<b>PRODUCT GROUP</b>	REV	ISSUE DATE
	TFT- LCD PRODUCT	P0	2012.2.6
SPEC. NUMBER	SPEC. TITLE BA101WS1-100 Preliminary Product Specification		PAGE 25 OF 36

## 10.0 Connector Description

Physical interface is described as for the connector on LCM.

These connectors are capable of accommodating the following signals and will be following components.

### 10.1 TFT LCD Module

Connector Name /Description	For Signal Connector
Manufacturer	STM
Type/ Part Number	MSAK24025P40G
Mating housing/ Part Number	-

[www.jxlcd.com](http://www.jxlcd.com)

 <b>京东方</b> <b>BOE</b>	<b>PRODUCT GROUP</b>	REV	ISSUE DATE
	TFT- LCD PRODUCT	P0	2012.2.6
SPEC. NUMBER	SPEC. TITLE BA101WS1-100 Preliminary Product Specification		PAGE 26 OF 36

## 11.0 MECHANICAL CHARACTERISTICS

### 11.1 Dimensional Requirements

FIGURE 6 shows mechanical outlines for the model BA101WS1-100.  
Other parameters are shown in Table 9.

<Table 9. Dimensional Parameters>

Parameter	Specification	Unit
Active Area	222.72 x 125.28	
Number of pixels	1024(H) X 600 (V) (1 pixel = R + G + B dots)	
Pixel pitch	0.2175X0.2088	
Pixel arrangement	RGB Vertical stripe	
Display colors	262,144	
Display mode	Normally white	
Dimensional outline	$245 \pm 0.5 \times 146.5 \pm 0.5 \times 3.6(\text{max})$	mm
Weight	170	gram
Back Light	Connector : Hot Pad	
	LED, Horizontal LED Array type	

### 11.2 Mounting

See FIGURE 6.

### 11.3 Glare and Polarizer Hardness.

The surface of the LCD has a glare coating to maximize readability and hard coating to reduce scratching.

### 11.4 Light Leakage

There shall not be visible light from the back-lighting system around the edges of the screen as seen from a distance 50cm from the screen with an overhead light level of 350lux.

 <b>京东方</b> <b>BOE</b>	<b>PRODUCT GROUP</b>	REV	ISSUE DATE
	TFT- LCD PRODUCT	P0	2012.2.6
SPEC. NUMBER	SPEC. TITLE BA101WS1-100 Preliminary Product Specification		PAGE 27 OF 36

## 12.0 RELIABILITY TEST

The Reliability test items and its conditions are shown in below.

<Table 10. Reliability test>

No	Test Items	Conditions
1	High temperature storage test	Ta = 50 °C, 240 hrs
2	Low temperature storage test	Ta = -20 °C, 240 hrs
3	High temperature & high humidity operation test	Ta = 40 °C, 90%RH, 240 hrs
4	High temperature operation test	Ta = 50 °C, 240 hrs
5	Low temperature operation test	Ta = 0 °C, 240 hrs
6	Thermal shock	Ta = -20 °C ↔ 60 °C (0.5 hr), 100 cycle
7	Vibration test (non-operating)	1.5G, 10~500Hz sine +X,+Y+Z Sweep rate : 60min.
8	Shock test (non-operating)	220G, Half Sine Wave 2msec ±X, ±Y, ±Z Once for each direction
9	Electro-static discharge test (non-operating)	Air : 150 pF, 330Ω, +-15 KV Contact : 150 pF, 330Ω, +-8 KV

## 13.0 HANDLING & CAUTIONS

### (1) Cautions when taking out the module

- Pick the pouch only, when taking out module from a shipping package.

### (2) Cautions for handling the module

- As the electrostatic discharges may break the LCD module, handle the LCD module with care. Peel a protection sheet off from the LCD panel surface as slowly as possible.
- As the LCD panel and back - light element are made from fragile glass material, impulse and pressure to the LCD module should be avoided.
- As the surface of the polarizer is very soft and easily scratched, use a soft dry cloth without chemicals for cleaning.
- Do not pull the interface connector in or out while the LCD module is operating.
- Put the module display side down on a flat horizontal plane.
- Handle connectors and cables with care.

### (3) Cautions for the operation

- When the module is operating, do not lose CLK, ENAB signals. If any one of these signals is lost, the LCD panel would be damaged.
- Obey the supply voltage sequence. If wrong sequence is applied, the module would be damaged.

 <b>京东方</b> <b>BOE</b>	<b>PRODUCT GROUP</b>	REV	ISSUE DATE
	TFT- LCD PRODUCT	P0	2012.2.6
SPEC. NUMBER	SPEC. TITLE BA101WS1-100 Preliminary Product Specification	PAGE 28 OF 36	

- (4) Cautions for the atmosphere
- Dew drop atmosphere should be avoided.
  - Do not store and/or operate the LCD module in a high temperature and/or humidity atmosphere. Storage in an electro-conductive polymer packing pouch and under relatively low temperature atmosphere is recommended.
- (5) Cautions for the module characteristics
- Do not apply fixed pattern data signal to the LCD module at product aging.
  - Applying fixed pattern for a long time may cause image sticking.
- (6) Other cautions
- Do not disassemble and/or re-assemble LCD module.
  - Do not re-adjust variable resistor or switch etc.
  - When returning the module for repair or etc., Please pack the module not to be broken. We recommend to use the original shipping packages.

## 14.0 LABEL

### (1) Product label

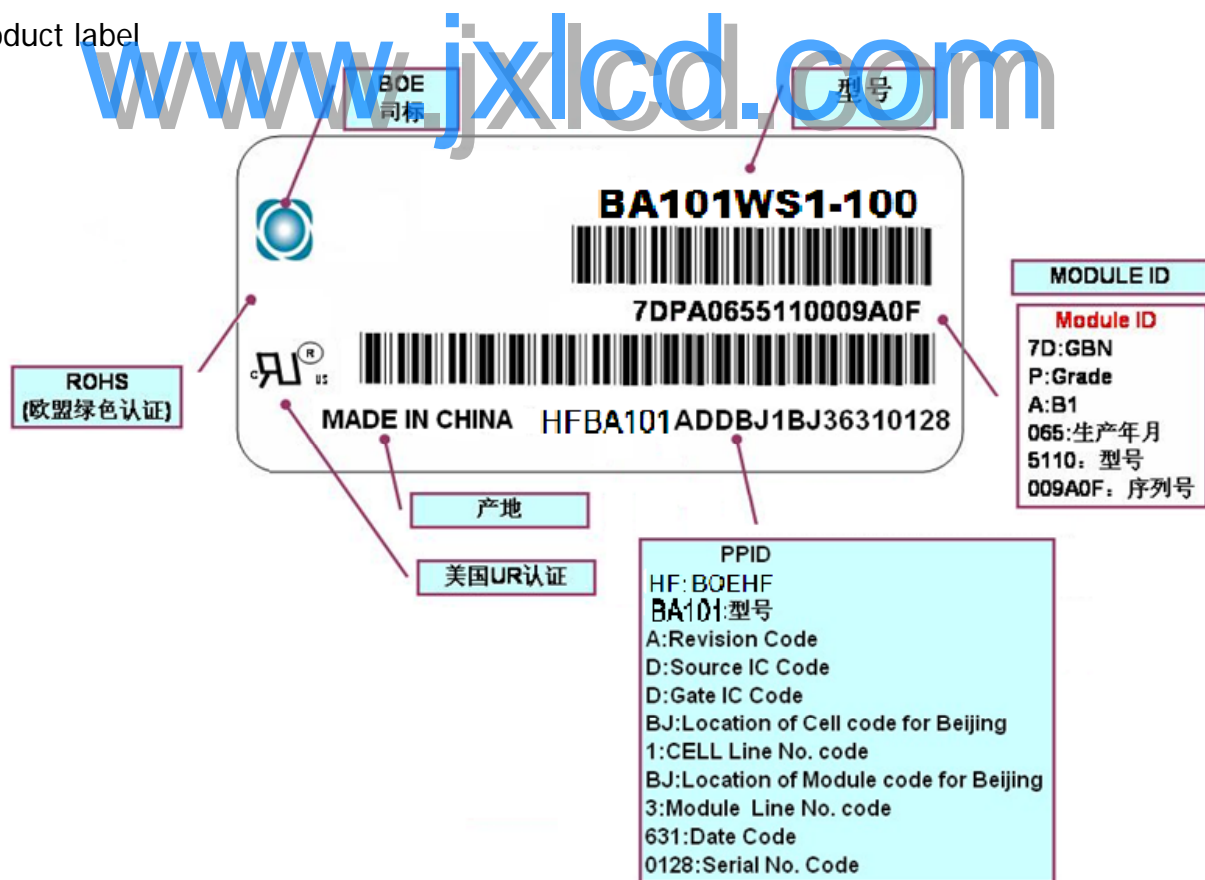

The diagram shows a product label for the BA101WS1-100 LCD module. The label contains the following information:

- BOE 司标** (BOE Logo)
- 型号** (Model): BA101WS1-100
- MODULE ID**: 7DPA0655110009A0F
- Module ID** breakdown:
  - 7D: GBN
  - P: Grade
  - A: B1
  - 065: 生产年月 (Production Year/Month)
  - 5110: 型号 (Model)
  - 009A0F: 序列号 (Serial No.)
- ROHS (欧盟绿色认证)** (RoHS (EU Green Certification))
- 产地** (Origin): MADE IN CHINA
- 美国UR认证** (US UR Certification)
- PPID** (Part Identification Code): HFBA101ADDBJ1BJ36310128
  - HF: BOEHF
  - BA101: 型号 (Model)
  - A: Revision Code
  - D: Source IC Code
  - D: Gate IC Code
  - BJ: Location of Cell code for Beijing
  - 1: CELL Line No. code
  - BJ: Location of Module code for Beijing
  - 3: Module Line No. code
  - 631: Date Code
  - 0128: Serial No. Code

 <b>京东方</b> <b>BOE</b>	<b>PRODUCT GROUP</b>	REV	ISSUE DATE
	TFT- LCD PRODUCT	P0	2012.2.6
SPEC. NUMBER	SPEC. TITLE BA101WS1-100 Preliminary Product Specification		PAGE 29 OF 36

(2) Box label

Label Size: 110 mm (L) × 56 mm (W)

Contents

Model: BA101WS1-100

Q`ty: Module Q`ty in one box

Serial No.: Box Serial No. See next figure for detail description.

Date: Packing Date

Internal use of Product

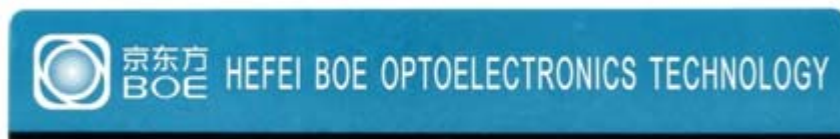

MODEL: BA101WS1-100

Q`TY: 50

SERIAL NO: 00000000000000

DATE: 201X.XX.XX

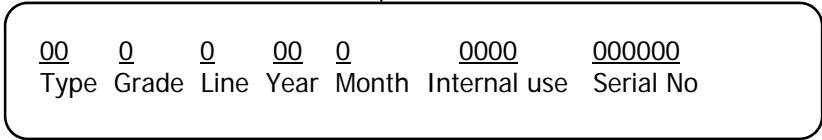

## 15.0 PACKING INFORMATION

- 将2pcs MDL依次平放入PET Tray
- 人工方式；
- 容量：2pcs MDL/ PET Tray

- 将26pcs PET Tray 平放入PE Bag
- 人工方式；
- 容量：50pcs/PE Bag

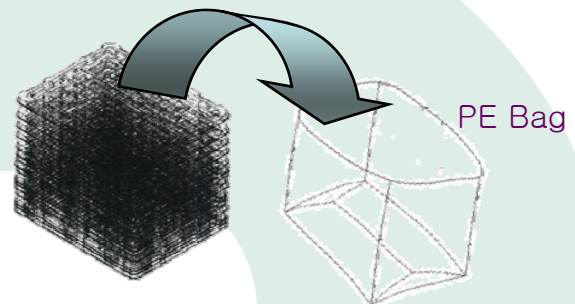
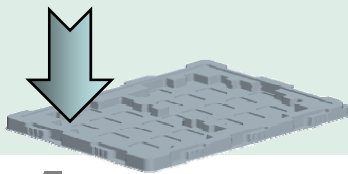

**step 1** PET Tray

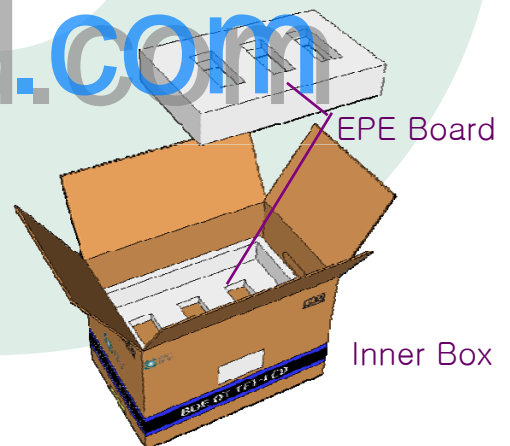
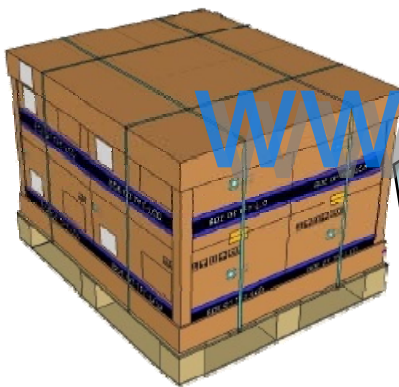

- 每个Pallet上放3层Box, 1层6箱, 共计18ea Box
- Pallet外包装 Top Cover & Paper Corner
- 人工方式
- 容量：900pcs/Pallet

- 将PET Tray堆码后平放入Inner Box 上下放置EPE Board
- 人工方式
- 容量：50pcs/Inner Box

### 15.2 Notes

- Box Dimension: 496mm(W) x 396mm(D) x 290mm(H)
- Package Quantity in one Box: 50pcs
- Total Weight: 12kg ?



PRODUCT GROUP

REV

ISSUE DATE

TFT- LCD PRODUCT

P0

2012.2.6

SPEC. NUMBER

SPEC. TITLE

PAGE

BA101WS1-100 Preliminary Product Specification

31 OF 36

### 16.0 MECHANICAL OUTLINE DIMENSION

Figure 6. TFT-LCD Module Outline Dimension (Front View)

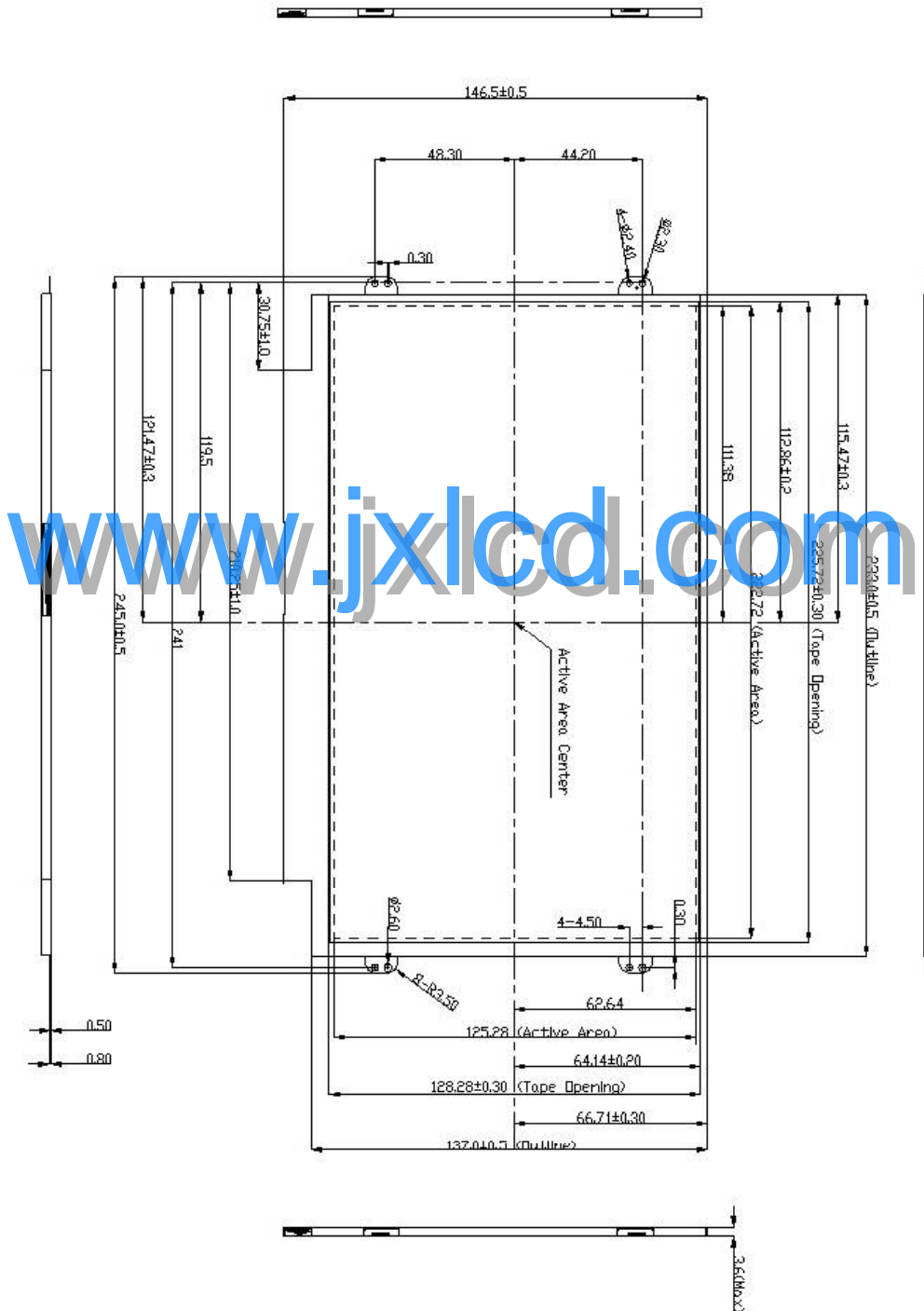

Note :  
1. LVDS Connector : MSAK24025P40



京东方  
BOE

PRODUCT GROUP

REV

ISSUE DATE

TFT- LCD PRODUCT

P0

2012.2.6

SPEC. NUMBER

SPEC. TITLE

PAGE

BA101WS1-100 Preliminary Product Specification

32 OF 36

Figure 7. TFT-LCD Module Outline Dimensions (Rear view)

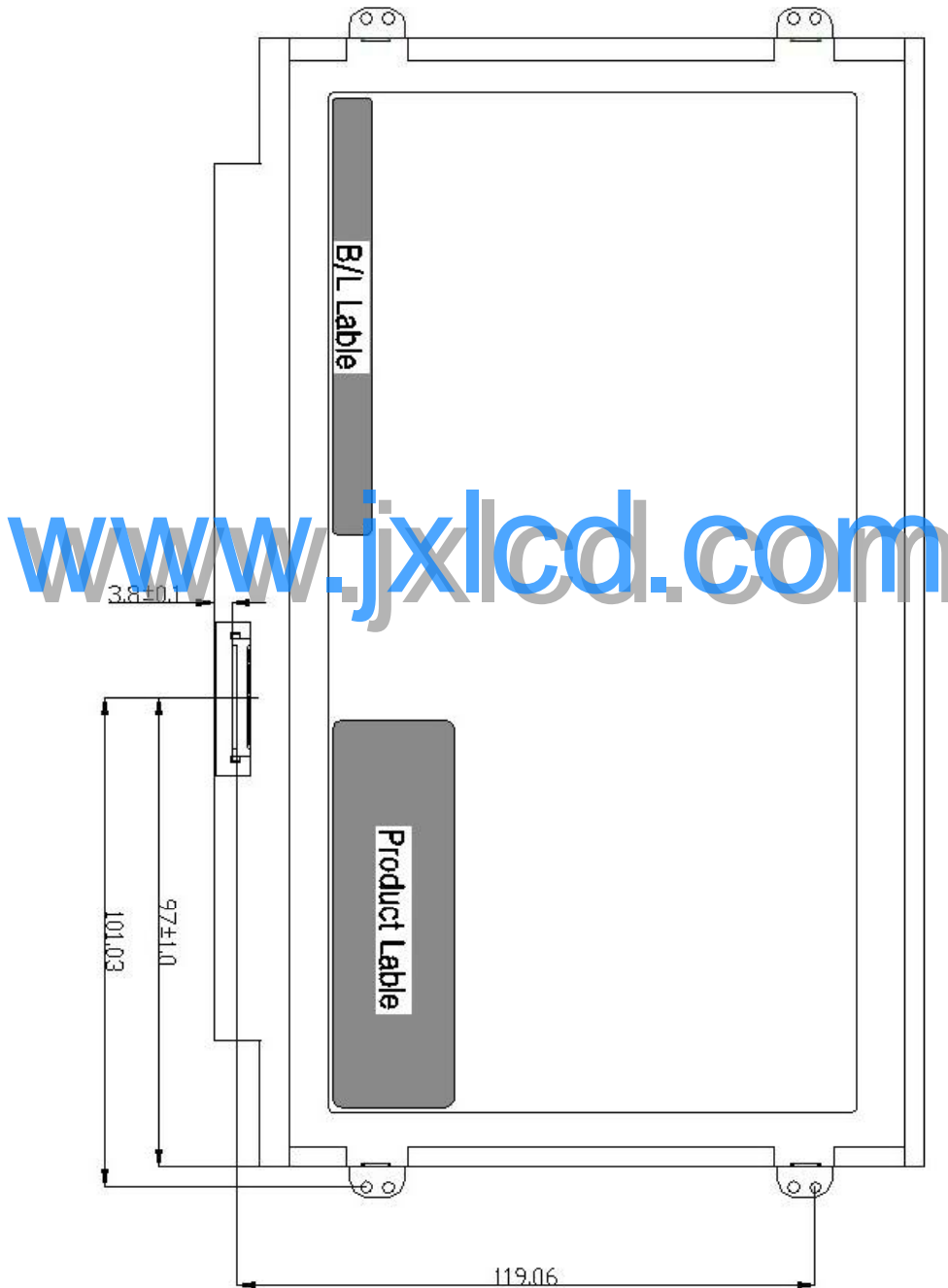

Note :  
1. LVDS Connector : MSAK24025P40





# PRODUCT GROUP

REV

ISSUE DATE

TFT- LCD PRODUCT

P0

2012.2.6

SPEC. NUMBER

SPEC. TITLE

BA101WS1-100 Preliminary Product Specification

PAGE

33 OF 36

## 17.0 EDID Table

Address (HEX)	Function	Hex	Dec	crc	Input values.	Notes
00	Header	00	0		0	EDID Header
01		FF	255		255	
02		FF	255		255	
03		FF	255		255	
04		FF	255		255	
05		FF	255		255	
06		FF	255		255	
07		00	0		0	
08	ID Manufacturer Name	09	9		BOE	ID = BOE
09		E5	229			
0A	ID Product Code	B3	179		1459	ID = 1459
0B		05	5			
0C	32-bit serial No.	00	0			
0D		00	0			
0E		00	0			
0F		00	0			
10	Week of manufacture	1	1		1	
11	Year of Manufacture	15	21		2011	Manufactured in 2011
12	EDID Structure Ver.	01	1		1	EDID Ver 1.0
13	EDID revision #	04	4		4	EDID Rev. 0.4
14	Video input definition	90	144		-	
15	Max H image size	22	34		34	34 cm (Approx)
16	Max V image size	13	19		19	19 cm (Approx)
17	Display Gamma	78	120		2.2	Gamma curve = 2.2
18	Feature support	0A	10			RGB display, Preferred Timing mode
19	Red/Green low bits	F8	248		-	Red / Green Low Bits
1A	Blue/White low bits	90	144		-	Blue / White Low Bits
1B	Red x high bits	9E	158	631	0.617	Red (x) = 10011110 (0.617)
1C	Red y high bits	59	89	359	0.351	Red (y) = 01011001 (0.351)
1D	Green x high bits	55	85	342	0.334	Green (x) = 01010101 (0.334)
1E	Green y high bits	9C	156	624	0.610	Green (y) = 10011100 (0.61)
1F	Blue x high bits	26	38	154	0.151	Blue (x) = 00100110 (0.151)
20	Blue y high bits	1A	26	105	0.103	Blue (y) = 00011010 (0.103)
21	White x high bits	50	80	320	0.313	White (x) = 01010000 (0.313)
22	White y high bits	54	84	336	0.329	White (y) = 01010100 (0.329)



PRODUCT GROUP

REV

ISSUE DATE

TFT- LCD PRODUCT

P0

2012.2.6

SPEC. NUMBER

SPEC. TITLE

BA101WS1-100 Preliminary Product Specification

PAGE

34 OF 36

Address (HEX)	Function	Hex	Dec	crc	Input values.	Notes
23	Established timing 1	00	0		-	
24	Established timing 2	00	0		-	
25	Established timing 3	00	0		-	
26	Standard timing #1	01	1			Not Used
27		01	1			
28	Standard timing #2	01	1			Not Used
29		01	1			
2A	Standard timing #3	01	1			Not Used
2B		01	1			
2C	Standard timing #4	01	1			Not Used
2D		01	1			
2E	Standard timing #5	01	1			Not Used
2F		01	1			
30	Standard timing #6	01	1			Not Used
31		01	1			
32	Standard timing #7	01	1			Not Used
33		01	1			
34	Standard timing #8	01	1			Not Used
35		01	1			
36	Detailed timing/monitor descriptor #1	04	4		71.72	71.72MHz Main clock
37		1C	28			
38		56	86		1366	Hor Active = 1366
39		93	147		147	Hor Blanking = 147
3A		50	80		-	4 bits of Hor. Active + 4 bits of Hor. Blanking
3B		00	0		768	Ver Active = 768
3C		16	22		22	Ver Blanking = 22
3D		30	48		-	4 bits of Ver. Active + 4 bits of Ver. Blanking
3E		30	48		48	Hor Sync Offset = 48
3F		20	32		32	H Sync Pulse Width = 32
40		36	54		3	V sync Offset = 3 line
41		00	0		6	V Sync Pulse width : 6 line
42		58	88		344	Horizontal Image Size = 344 mm (Low 8 bits)
43		C1	193		193	Vertical Image Size = 193 mm (Low 8 bits)
44		10	16		-	4 bits of Hor Image Size + 4 bits of Ver Image Size
45		00	0		0	Hor Border (pixels)
46		00	0		0	Vertical Border (Lines)
47	1A	26			Refer to right table	



PRODUCT GROUP

REV

ISSUE DATE

TFT- LCD PRODUCT

P0

2012.2.6

SPEC. NUMBER

SPEC. TITLE

BA101WS1-100 Preliminary Product Specification

PAGE

35 OF 36

Address (HEX)	Function	Hex	Dec	crc	Input values.	Notes
48	Detailed timing/monitor descriptor #2	D6	214		48.22	48.22MHz Main clock
49		12	18			
4A		56	86		1366	Hor Active = 1366
4B		A0	160		160	Hor Blanking = 160
4C		50	80		-	4 bits of Hor. Active + 4 bits of Hor. Blanking
4D		00	0		768	Ver Active = 768
4E		16	22		22	Ver Blanking = 22
4F		30	48		-	4 bits of Ver. Active + 4 bits of Ver. Blanking
50		30	48		48	Hor Sync Offset = 48
51		20	32		32	H Sync Pulse Width = 32
52		36	54		3	V sync Offset = 3 line
53		00	0		6	V Sync Pulse width : 6 line
54		58	88		344	Horizontal Image Size = 344 mm (Low 8 bits)
55		C1	193		193	Vertical Image Size = 193 mm (Low 8 bits)
56		10	16		-	4 bits of Hor Image Size + 4 bits of Ver Image Size
57		00	0		0	Hor Border (pixels)
58		00	0		0	Vertical Border (Lines)
59	1A	26				
5A	Detailed timing/monitor descriptor #3	00	0			ASCII Data Sting Tag
5B		00	0			
5C		00	0			
5D		FE	254			
5E		00	0			
5F		36	54		6	D/PN: 6D6V7
60		44	68		D	
61		36	54		6	
62		56	86		V	EDID: X10
63		37	55		7	
64		0A	10		1010	
65		48	72		H	
66		42	66		B	
67	31	49		1		
68	35	53		5		
69	31	49		1		
6A	30	48		0	BOE PN	
6B	30	48		0		



PRODUCT GROUP

REV

ISSUE DATE

TFT- LCD PRODUCT

P0

2012.2.6

SPEC. NUMBER

SPEC. TITLE

BA101WS1-100 Preliminary Product Specification

PAGE

36 OF 36

Address (HEX)	Function	Hex	Dec	crc	Input values.	Notes
6C	Detailed timing/monitor descriptor #4	00	0			Product Name Tag (ASCII)
6D		00	0			
6E		00	0			
6F		00	0			
70		00	0			
71		00	0		00000000	6-bit Color Depth & no FRC
72		41	65		01000001	WLED & singal light bar & one light bar
73		01	1		00000001	Frame rate 40Hz~65Hz
74		94	148		10010110	Light Controller:PWM & Max. Luminance 220
75		01	1		00000001	Front Surface:Glossy & RGB v-stripe
76		00	0		00000000	no NTSC & no DBC
77		00	0		00000000	no Motion Blur & no Active Gamma
78		00	0		00000000	no Wireless Enhancement & no In-Cell Scanner
79		01	1		00000001	Single LVDS
7A	01	1		00000001	Built-in Self Test	
7B	0A	10				
7C	20	32				
7D	20	32				
7E	Extension flag	00	0			
7F	Checksum	43	43	67	-	