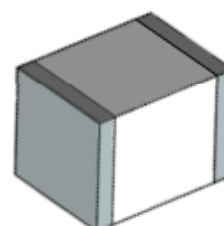

Features

- Small Size Design EIA 1812 4.5×3.2×2.7mm
- Current Handling Capability 1,000A @ 8/20 μ s
- Low Capacitance and Insertion Loss
- Fast Response and Long Service Life
- Reliable to Protect Electrostatic Surge
- Moisture sensitivity level: Level 1

Exterior

SMD

Application information

- xDSL

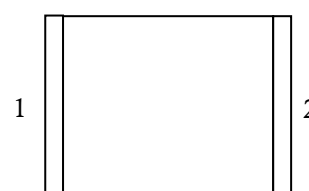
Package (Top View)

Agency Approvals

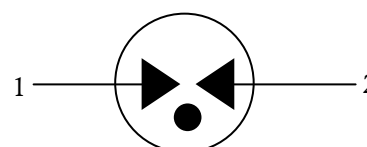
| Icon | Description |
|-------------------------------------------------------------------------------------|------------------------------------|
| RoHS | Compliance with 2011/65/EU |
| HF | Compliance with IEC61249-2-21:2003 |
|  | Mean lead free |

Schematic Symbol

Electrical Parameter

| | | | |
|-----------------------------------|-----------|--------------------------------|-------|
| DC Breakdown Voltage 1)2) | 100V/s | 340-550 | V |
| Impulse Spark-over Voltage | At 1kV/μs | for 99 % of measured values | ≤ 750 |
| | At 1kV/μs | Typical values of distribution | ≤ 700 |
| Impulse Discharge Current 3) | 8/20μs | 1,000 | A |
| Arc Voltage | At 1A | ~15 | V |
| Insulation Resistance | DC=100V | ≥1 | GΩ |
| Capacitance at 1 MHz | VDC=0.5V | ≤1.0 | pF |
| Weight | | ~0.20 | g |
| Operating And Storage Temperature | | -40-90 | °C |
| Marking | | Without | |

1) At delivery AQL 0.65 level II GB/T 2828.1-2003

2) In ionized mode

3) Terms and waveforms in accordance with ITU-T Rec. K. 12; IEC 61643-21

Part Numbering System

BA 401 N - D

(1) (2) (3) (4)

(1) Bencent Gas Discharge Tube

 (2) Series: DC Breakdown Voltage, e.g.: $401=40 \times 10^1=400V$

 (3) Tolerance of DC Breakdown Voltage, $M=+20\%$,
 $N=+30\%$, the Specific tolerance is decided by the table of

"Electrical Parameter"

(4) "-D" denotes lower impulse Vbo product

Product Characteristics

| | |
|-----------------|-----------------------------|
| Lead Material | Copper or iron nickel alloy |
| Body Material | Ceramics |
| Terminal Finish | 100% Matte-Tin Plated |

Environmental Reliability Characteristics

| Testing items | Technical standards |
|-------------------------------|-----------------------------------------------------------|
| High Temperature Storage Test | Temperature: 85°C Time: 2H |
| Low Temperature Storage Test | Temperature: -40°C Time: 2H |
| Vibration | Frequency: 10-500Hz Amplitude: 0.15mm Time: 45mins |
| Resistance of soldering heat | Temperature: 260±5°C Time of dip soldering: 10s, 1time |

Note: Up-screen program can be specified by customer's request via contacting Bencent service

Solderability test

| | | |
|---------------|-------------------------|-------------|
| Solderability | Solder Pot Temperature: | 245°C ± 5°C |
| | Solder Dwell Time: | 4-6 seconds |

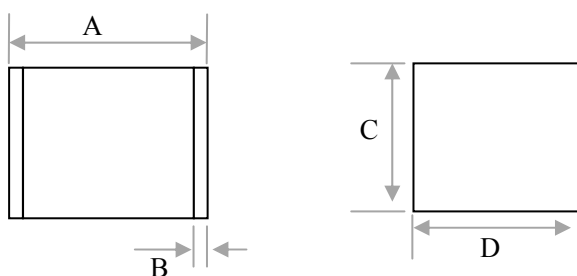
Product Dimensions

| REF | mm | inch |
|-----|---------|-------------|
| A | 4.5±0.3 | 0.177±0.012 |
| B | 0.5±0.2 | 0.020±0.008 |
| C | 2.7±0.2 | 0.106±0.008 |
| D | 3.2±0.2 | 0.126±0.008 |

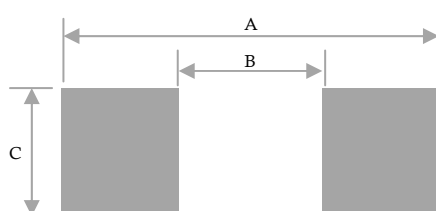
Recommended Soldering Pad

| REF | mm | inch |
|-----|-----|-------|
| A | 5.5 | 0.217 |
| B | 3.5 | 0.138 |
| C | 3.5 | 0.138 |

Reflow Profile

| Reflow Condition | | Pb-Free assembly |
|---------------------------------------------------------------------------|-------------------------------------------|------------------|
| Pre Heat | Temperature Min | 150°C |
| | Temperature Max | 200°C |
| | Time (min to max) | 60 – 180 secs |
| Average ramp up rate (Liquids) T _{amp} (T _L) to peak | | 3°C/second max |
| T _S (max) to T _L - Ramp-up Rate | | 3°C/second max |
| Reflow | - Temperature (T _L) (Liquids) | 217°C |
| | - Temperature (T _L) | 60 – 150 seconds |
| Peak Temperature (T _p) | | 260±0/-5 °C |
| Time within 5°C of actual peak Temperature (t _p) | | 8 – 20 seconds |
| Ramp-down Rate | | 6°C/second max |
| Time 25°C to peak Temperature (T _p) | | 8 minutes Max. |
| Do not exceed | | 260°C |

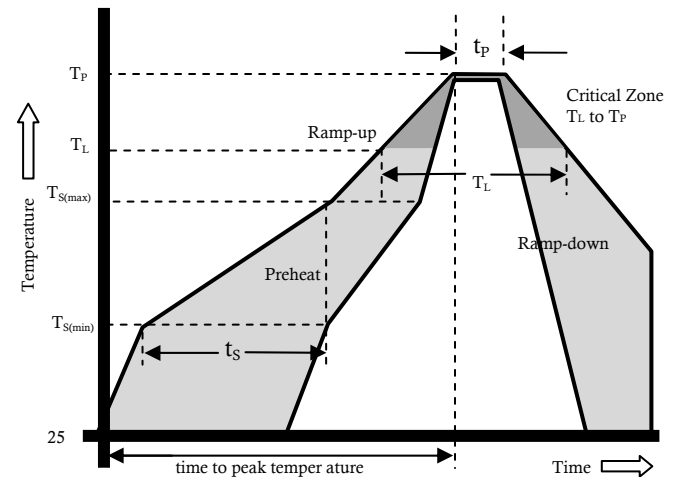

Package Reel Information

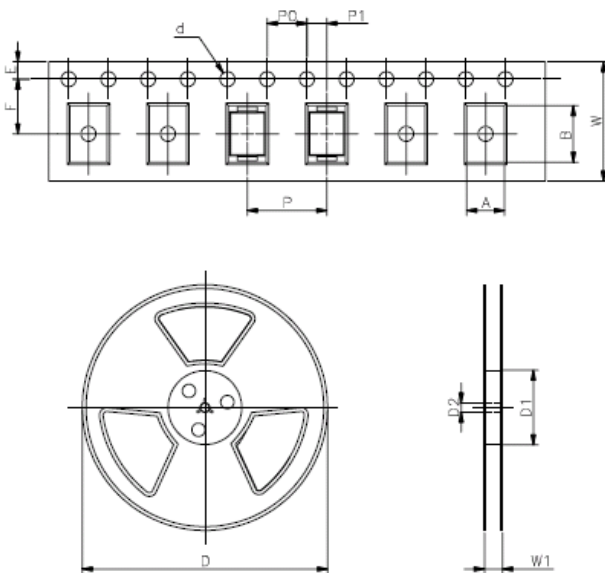

| REF | mm | inch |
|-----|----------|--------------|
| A | 3.7±0.2 | 0.146±0.008 |
| B | 4.7±0.2 | 0.185±0.008 |
| d | Φ1.5±0.1 | Φ0.059±0.004 |
| E | 1.75±0.1 | 0.069±0.004 |
| F | 5.5±0.1 | 0.217±0.002 |
| P | 8.0±0.1 | 0.315±0.004 |
| P0 | 4.0±0.1 | 0.157±0.004 |
| P1 | 2.0±0.1 | 0.079±0.004 |
| W | 12.0±0.2 | 0.472±0.008 |
| D | Φ330.0 | Φ13.0 |
| D1 | Φ50Min | Φ1.97Min |
| D2 | Φ13±0.15 | 0.512±0.006 |
| W1 | 16.8±2.0 | 0.661±0.079 |

| OUTLINE | REEL (PCS) | PER CARTON (PCS) | REEL DIAMETERS (mm) | CARTON SIZE(mm) | | |
|---------|------------|------------------|---------------------|-----------------|-----|-----|
| | | | | L | W | H |
| TAPING | 2,000 | 32,000 | 330 | 360 | 360 | 380 |