

BA4236L BA4237L

FM/AM IF system

The BA4236L and BA4237L ICs are a combined AM and FM detector and intermediate frequency (IF) (10.7 MHz) amplifier.

The FM component consists of a differential IF amplifier, and a double-balance type quadrature detector. The AM component consists of an oscillator, a double-balance type mixer, an IF amplifier, a detector circuit and an AGC.

In addition, each IC has a built-in LED driver circuit for display of AM or FM band and an audio amplifier.

The S-shape characteristic of the FM output can be selected normal or reverse according to the AFC circuit used. The BA4236L is used for upper heterodyne and the BA4237L is used for lower heterodyne.

Features

- available in a ZIP18 package
- BA4237L lower heterodyne
- BA4236L upper heterodyne
- wide operating voltage range (2.7 V ~ 12.0 V)
- uses shunt AGC for AM to improve input characteristics during strong RF signal presence
- FM demodulation uses a quadrature system
- built in circuit for suppression of white noise when receiving weak signals, between stations, and when not tuned accurately

Dimensions (Units : mm)

BA4236L (ZIP18)
BA4237L

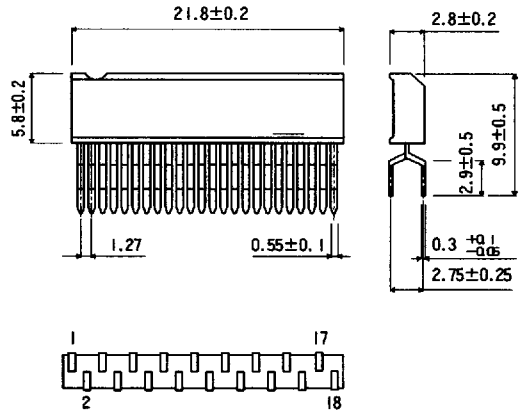

- FM and AM outputs can be switched by switching dc voltage on and off
- built-in muting allows maximum audio attenuation. Reduces noise between stations and when tuned to weak signals
- single FM and AM output terminal enabling connection to multiplexer without a switch
- provided with a frequency setting terminal for AM use. Allows independent frequency characteristics for AM and FM to be used. Connection to multiplexer circuit is simplified
- small and compact requiring few external components

Applications

- FM/AM radio cassette recorder
- home stereo

Block diagram

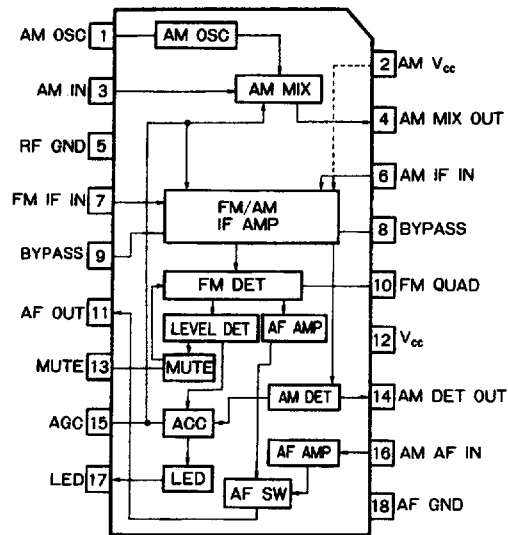

Absolute maximum ratings ($T_a = 25^\circ\text{C}$)

Parameter	Symbol	Limits	Unit	Conditions
Power supply voltage	V_{CC}	16	V	
Power dissipation	P_d	550	mW	Reduce power by 5.5 mW for each degree above 25°C.
Operating temperature	T_{opr}	-25 ~ +75	°C	
Storage temperature	T_{stg}	-55 ~ +125	°C	

Recommended operating conditions ($T_a = 25^\circ\text{C}$)

Parameter	Symbol	Min	Typical	Max	Unit
Power supply voltage	V_{CC}	2.7	6	12	V

FM electrical characteristics ($T_a = 25^\circ\text{C}$, $V_{CC} = 5.5\text{ V}$, $f_{IN} = 10.7\text{ MHz}$, $f_m = 1\text{ kHz}$, $\text{DEV} = 30\%$, $\Delta f = \pm 22.5\text{ kHz}$, $V_{IN} = 100\text{ dB}\mu\text{V}$)

Parameter	Symbol	Min	Typical	Max	Unit	Conditions
Quiescent current	I_Q		9	14	mA	MUTE OFF
-3 dB limiting sensitivity	V_{IN}	26	30	34	dB μV	$V_{OUT} = -3\text{ dB}$
Detector output	V_{OUT}	70	100	130	mV	
Total harmonic distortion	THD		0.06	0.25	%	
Signal-to-noise ratio	S/N	64	70		dB	
LED sensitivity	$V_{IN(LED)}$	44	49	54	dB μV	$I_{LED} = 1\text{ mA}$
Noise (no input)	N	-20	-30		dB	Ratio with V_{OUT} with std input
Noise suppression ratio	NS	35			dB	With MUTE on

AM electrical characteristics ($T_a = 25^\circ\text{C}$, $V_{CC} = 5.5\text{ V}$, $f_{IN} = 1000\text{ kHz}$, $f_m = 1\text{ kHz}$, $\text{Modulation} = 30\%$, $V_{IN} = 74\text{ dB}\mu\text{V}$)

Parameter	Symbol	Min	Typical	Max	Unit	Conditions
Detector output	V_O	70	110	140	mV	
Total harmonic distortion	THD		0.8	2.5	%	
Signal-to-noise ratio	S/N	44	52		dB	
Maximum sensitivity	$V_{IN(max)}$	5	8	13	dB μV	$V_{OUT} = 1\text{ mVrms}$
LED sensitivity	$V_{IN(LED)}$	18	23	28	dB μV	$I_{LED} = 1\text{ mA}$

Note: For the test circuit, see Figure 1.

Figure 1 Test circuit

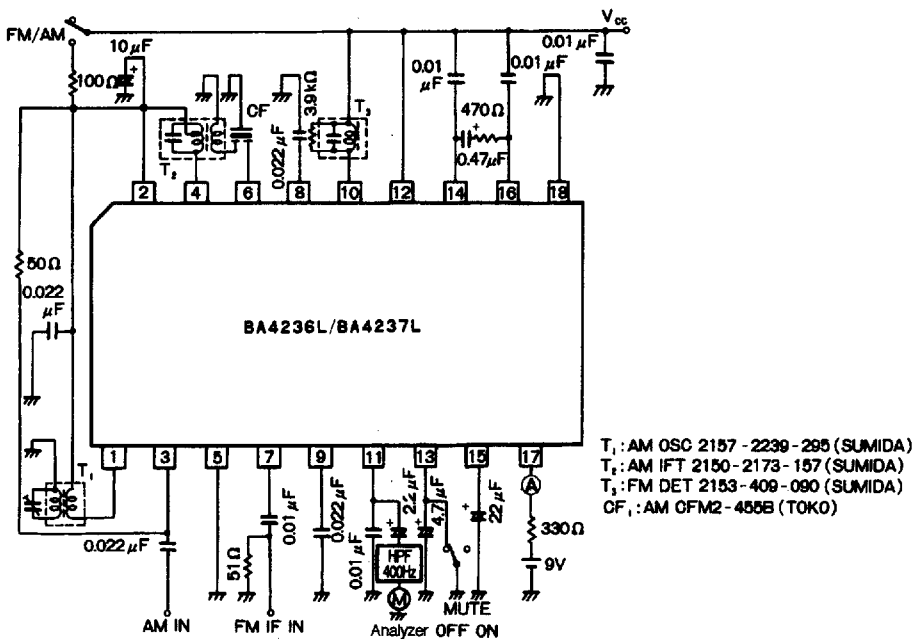

Pin connections

Pin no.	Pin name	Function
1	AM oscillator	Connected to the second side of the oscillation coil
2	AM V_{CC}	AM/FM band switcher
3	AM signal input	Connected to the second side of the AM antenna
4	AM mixer output	Connected to the AM IFT
5	GND	For high frequency
6	AM IF input	Connected to the AM ceramic filter
7	FM IF input	Connected to the FM ceramic filter
8	IF amplifier bypass	Connected to the bypass capacitor
9	IF amplifier bypass	Connected to the bypass capacitor
10	FM phase-shift coil	Connected to the phase-shifting coil
11	Audio output	Next-stage (MPX etc.) connection
12	V_{CC}	Connected to the power supply
13	FM mute	Connected to the capacitor
14	AM detector output	Connected to the RC filter
15	AGC	Connected to the capacitor
16	AM audio input	Connected to the RC filter
17	Tuning LED	Connected to the tuning LED
18	GND	For low frequency

Circuit operation

AM/FM IF amplifier

The AM/FM IF amplifier is a 3-stage differential amplifier. The second and third stages are shared by the AM and FM bands. The current changes caused by AM/FM band switching, causes the respective independent amplifiers in the first stage to switch in.

The gain at this stage is 50 dB for both AM and FM. When switched to AM, AGC is applied to the first stage. Because the dc balance of the circuit breaks down when the amplifier is cut off by the AGC, it is configured so as to not completely cut off. Distortion is suppressed when the amplifier is cut off by this mechanism, operating quickly, transferring AGC operation of the RF stage.

The FM input impedance is determined by the IC's internal resistance, and it is about 400 Ω . It can be directly connected to a 330 Ω ceramic filter.

The AM input impedance is approximately 2.2 k Ω and can be directly connected to a 2 k Ω or 3 k Ω ceramic filter.

Figure 2 FM/AM IF amplifier

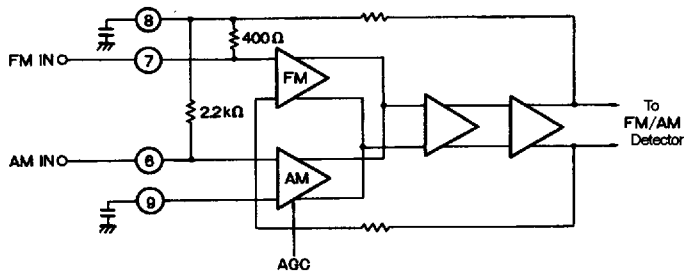
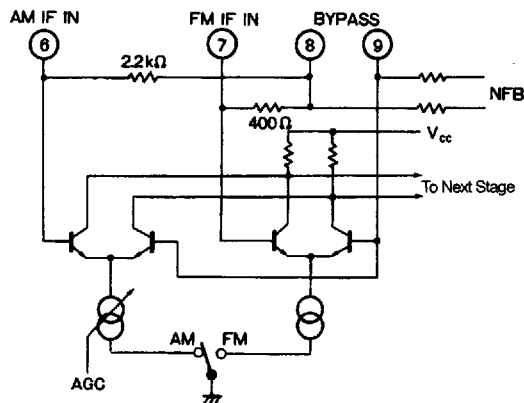

Figure 3 FM/AM IF amplifier equivalent circuit



FM detector

The FM detector circuit uses a quadrature detector system.

The IF-amplified signal is input to the detector through a limiter amplifier with a gain of 12 dB. The output impedance of the limiter amplifier is made as small as possible so that the maximum oscillation span input to the detector, and the conditions for a 90° phase-shift, do not fall out of synchronization.

To improve the linearity of the 90° phase-shift, a buffer is put into the side where the phase-shift is output.

To reverse the respective S-shaped characteristics of the FM output in the BA4236L and the BA4237L, the phase is shifted -90° in the BA4236L and +90° in the BA4237L. By this, two types of S-shaped characteristics are created. These are compatible to the AFCs of both upper and lower heterodyne systems.

Figure 4 FM detector equivalent circuit

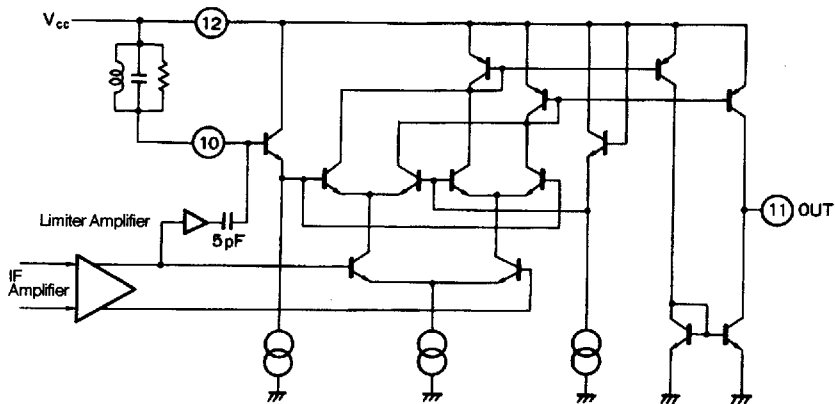

AM mixer

The AM mixer circuit is a double-balance type and is designed to have low oscillation leakage.

For the mixer input, bias is applied by the AM V_{CC} through the antenna coil.

An AGC that lowers mixer conversion gain is applied to the medium to strong magnetic fields, and, in strong magnetic fields, favorable strong input characteristic can be obtained by an input-shunt AGC.

Figure 5 AM mixer equivalent circuit

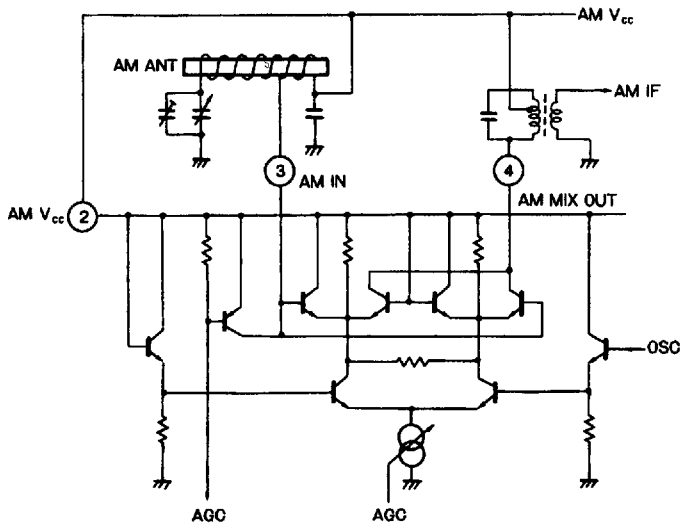

AM local oscillator

The AM oscillator is made up of a positive-feedback loop from a differential amplifier with a buffer circuit from an emitter follower.

This buffer reduces frequency variations caused by the input signal.

In consideration of oscillations approaching the switching band, the feedback resistance is set at 300 Ω, and a 100 Ω resistor is connected in series with the tank circuit.

Figure 6 AM local oscillator equivalent circuit

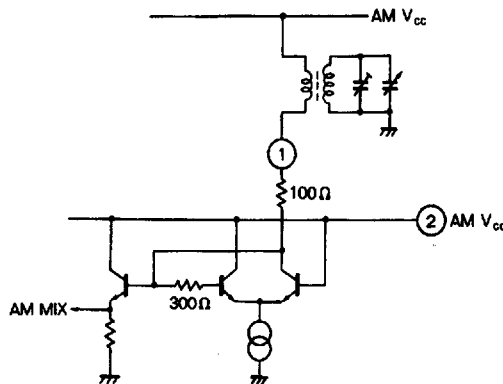

AM detector

The AM detector circuit is an envelope detector that uses an emitter follower and, since it uses a differential signal from the AM IF, its detection efficiency is excellent.

Figure 7 AM detector equivalent circuit

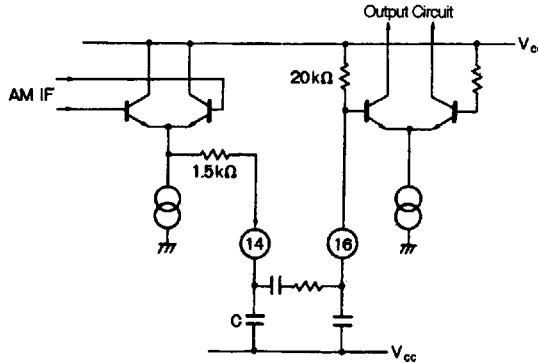

AM AGC

The AGC is applied to the mixer circuit and an IF circuit.

The AGC reduces the mixer and the IF circuit currents in proportion to the dc level of the detector output. This lowers the gain of these components regulating the output so that it remains constant.

In addition, the circuit is equipped with an input shunt to reduce the response to a very strong input. This prevents distortion of the signal.

Figure 8 AM AGC equivalent circuit

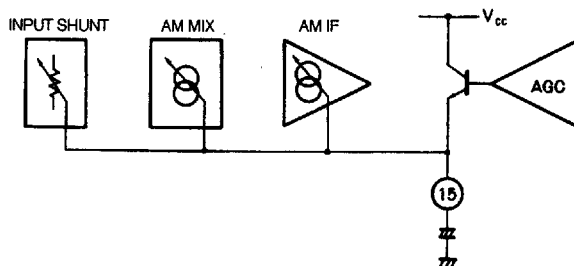

AM/FM tuning LED driver

The AM/FM tuning LED can be driven directly by the IC. This circuit detects the IF level for both AM and FM, amplifies it through the AGC amplifier and drives the tuning LED by using the voltage applied to pin 15.

Since the IF level only is detected, the tuning band is determined by the ceramic filter that is attached to each IF input.

Figure 9 AM/FM tuning LED driver equivalent circuit

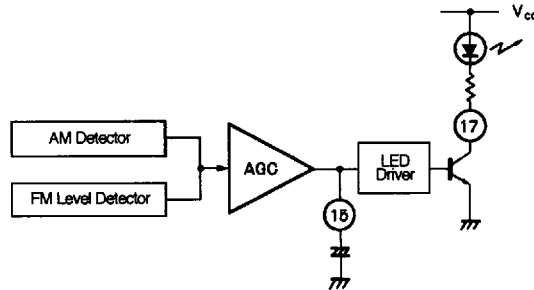

AM/FM detector output circuit

Detector output is the 1-pin type, and AM/FM switching takes place inside the IC. The output impedance is approximately 5 k Ω and the output voltage is approximately 2 V dc.

Figure 10 AM/FM detector output equivalent circuit

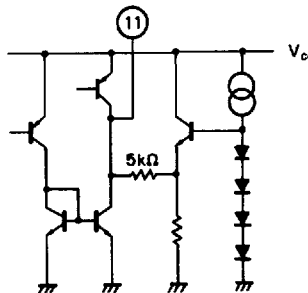

External components

AM oscillator external circuit (pin 1)

- When connecting the IC to the second side of the AM oscillator coil, oscillation leakage decreases when it is decoupled with an RC circuit.
- The power supply should be taken from pin 2.
- When the Q of the oscillation coil decreases in the switching band, the oscillation may become unstable. If a resistor is connected between the oscillation coil and the IC, the unit will remain stable, see Figure 11.
- Keep the voltage drop to less than 0.2 V, due to resistance between pin 1 and pin 2
- Set the oscillation voltage at pin 1 between 80 mV_{rms} and 300 mV_{rms}. The characteristics related to the oscillation voltage are shown in Figure 12.

Figure 11 AM oscillator circuit

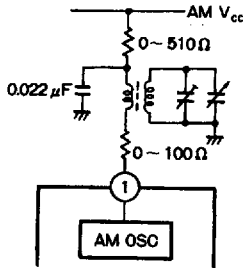
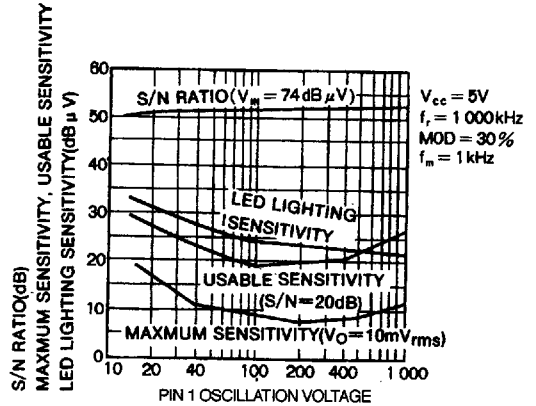

Figure 12 Oscillator voltage and IC sensitivity



AM power supply filter (pin 2)

The AM power supply (V_{CC}) changes over between the AM/FM by using a switch. If voltage is applied to pin 2, the unit switches to the AM band.

Noise which occurs when switching between AM and FM can be decreased by installing an RC filter. The voltage drop due to resistance between pin 12 and pin 2 should be kept to less than 0.5 V.

Figure 13 AM power supply filter

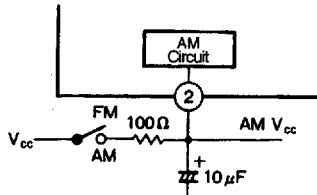

AM RF input (pin 3)

The AM RF input pin is the V_{CC} bias. Make the dc voltage on pin 3 the same as that on pin 2. When there is a voltage drop, local oscillation leakage to the mixer output becomes large and could cause spurious signals.

Figure 14 AM RF input

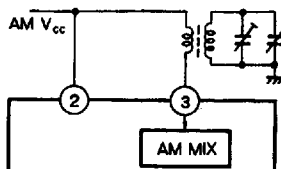

AM mixer output (pin 4)

For the AM mixer output, use an IFT coil that is compatible with the ceramic filter. Take the IFT bias from pin 2 and make it the same potential as that on pin 4. Make the wiring between pin 4 and the coil as short as possible.

Figure 15 AM mixer output

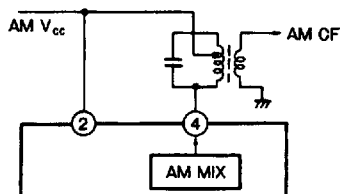

AM IF input (pin 6)

Since the AM IF input impedance is approximately $2.2\text{ k}\Omega$, a ceramic filter in the $1.8 - 3\text{ k}\Omega$ range can be directly connected to pin 6. There is a possibility that the tuning LED will light in error and sensitivity will decrease if local oscillation leakage and other noise is present on the input terminal. To avoid this, make the wiring between pin 6 and the ceramic filter as short as possible. In addition, ground the ceramic filter to the pin 5 ground.

Figure 16 AM IF input

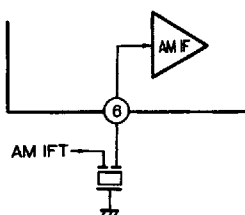

FM IF input (pin 7)

The input impedance of the FM IF is approximately $400\ \Omega$, so a ceramic filter in the $300\ \Omega$ range can be directly connected to this pin. Make the wiring between pin 7 and the ceramic filter as short as possible. In addition, ground the ceramic filter to the pin 5 ground.

Figure 17 FM IF input

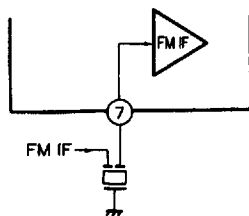

IF amplifier bypass capacitor (pins 8 and 9)

Connect these pins to the pin 5 ground using capacitors with good high-frequency characteristics. If the capacitance is too small, operation in the AM band becomes unstable. Use of a 0.022 μF capacitor is recommended.

Figure 18 IF amplifier bypass capacitor

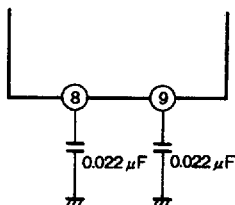

FM quadrature phase-shifting coil (pin 10)

R is the damping resistor of the phase-shifting coil. When R is made larger, detection becomes greater but the distortion rate deteriorates. When R is made smaller, the distortion rate improves but output decreases and the S/N ratio deteriorates. Examples of the change in characteristics due to R are shown in Figure 20.

Figure 19 FM quadrature phase-shifting coil

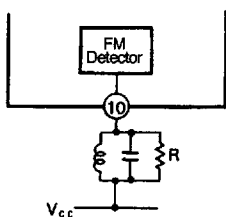
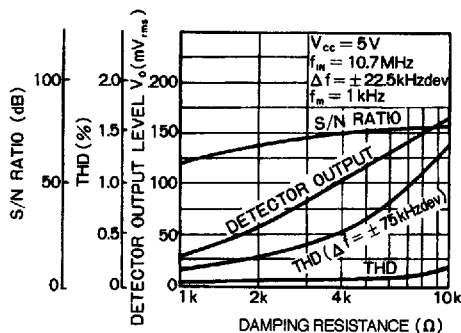

Figure 20 Behavior of circuit with changes in damping resistor



For the ground-connection point of the phase-shifting coil, use the pin 18 ground or the V_{CC} . In addition, make the bias of pin 10 the same potential as that of the pin 12.

Note: If the pin 5 ground is used, the circuit may become unstable due to feedback.

Detector output low pass filter (LPF) (pin 11)

When tuned to the AM band, the audio output is not affected substantially by this filter because the signal has already passed through the high pass band filter on pins 14 to 16 on the previous stage.

For FM, this pin determines the value of C as seen by the next stage. In the case of monaural output, for de-emphasis, the capacitor should have a value of $0.01 \mu\text{F}$ at $50 \mu\text{s}$ and $0.015 \mu\text{F}$ at $75 \mu\text{s}$ (with a pin 11 output impedance of $5 \text{ k}\Omega$).

For stereo output, since the FM multiplexer is the next stage, set the capacitor value at $100 \sim 1000 \text{ pF}$. Be careful, since, if the output is not connected to the next stage, the IF output is returned to the previous stage and the circuit may become unstable.

Figure 21 Detector output low pass filter

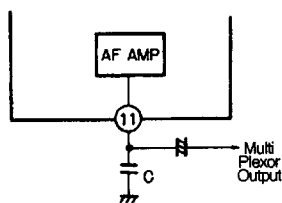

FM audio muting (pin 13)

FM audio muting can be switched ON and OFF with a switch. When pin 13 is connected to ground, muting is turned OFF. If C is made too small, full muting may not occur for detuning. If R is made very large (∞), then muting will occur even when the set is perfectly tuned to a particular RF signal, that is, hard muting.

When R is decreased, the result is soft muting. Caution must be used when selecting the value of R because the attenuation will change due to front-end noise. The muting characteristic in a single IF unit is shown in Figure 23.

Figure 22 FM audio muting

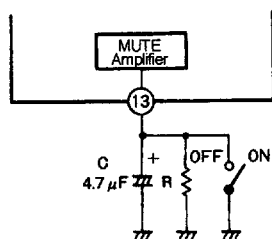
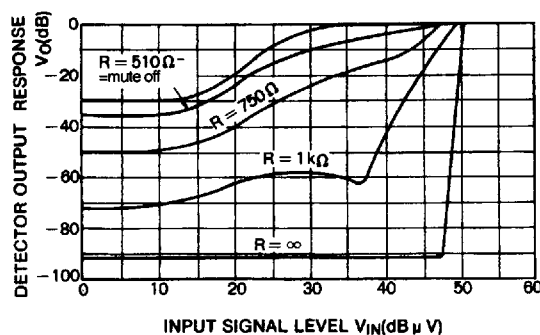

Figure 23 Behavior of muting as resistor R is changed



When observing the S-curve using the sweep generator, turn the muting OFF. If the S-curve is viewed with muting ON, the correct curve will not be seen because of the muting time constant.

AM audio filter (pins 14 and 16)

An AM audio filter can be connected between pins 14 and 16. First, a low pass filter (LPF) can be configured using R_1 and C_1 . C_1 also serves as the LPF of the AM detector.

Next, a high pass filter can be configured using C_2 and R_3 . If C_2 is made too large, the audio output will temporarily stop when switching between AM and FM, so use a $1 \mu\text{F}$ capacitor or less.

It is also possible to configure an LPF using R_2 and C_3 . Note that if this low pass filter is used, attenuation in the audio output will be due to R_2 and R_3 . Examples of the frequency characteristics with various filters are shown in Figure 25.

Figure 24 AM audio filter

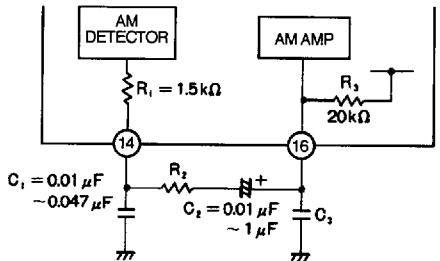
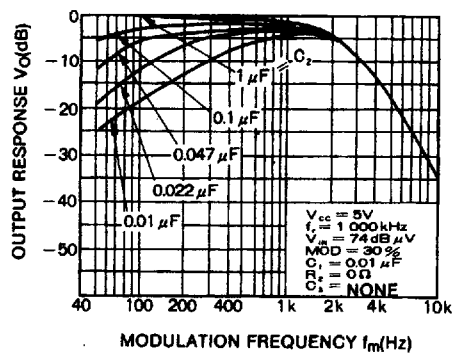
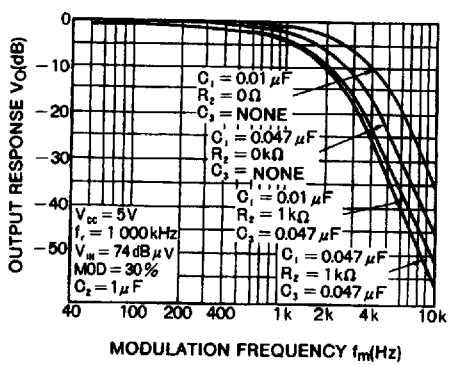

Figure 25 Audio output characteristics with different AM audio filters



AM AGC time constant (pin 15)

When the capacitance of the AGC low pass filter is decreased, distortion becomes greater in the lower modulation frequencies. However if the capacitance is increased, the AGC response is delayed more, leading to a varying output. Figure 26 shows how these characteristics change as the value of the capacitance is changed on pin 15.

Figure 26 AM AGC time constant

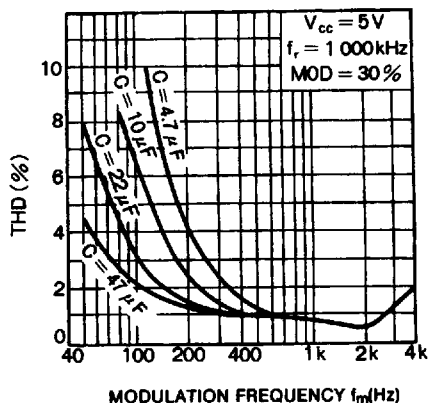
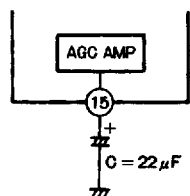
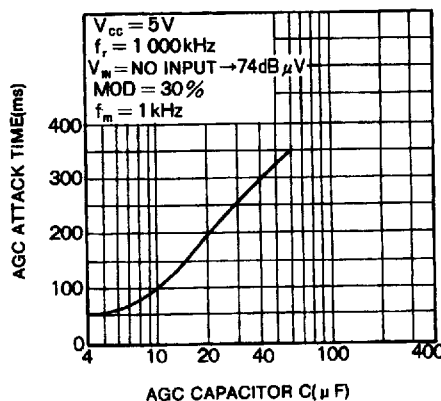
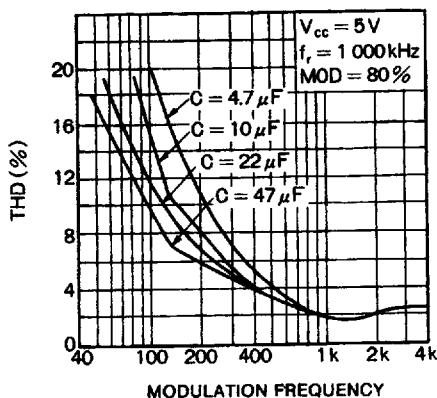

Figure 27 Audio output characteristics with varying AM AGC capacitance



Tuning indicator (pin 17)

The inflow of current to pin 17 is restricted by the resistor R connected to this pin. This current is determined as follows:

$$I_{17} = (V_{B-2}) / R.$$

Set the value of R so that the maximum current is 15 mA or less. The maximum applied voltage at pin 17 must be less than 12 V.

Figure 28 Tuning indicator

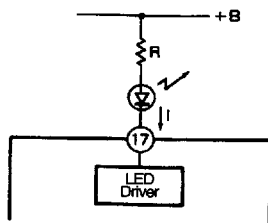

FM AFC circuit

It is possible to set the AFC in the circuit using the dc voltage on the pin 11 detector output. Whether to use the BA4236L or the BA4237L is determined by the circuit configuration of the front-end component. An example showing the use of BA4424N as the front end is shown in Figure 29. Use the BA4236L for upper heterodynes and the BA4237L for lower heterodynes.

Figure 29 Application example (with BA4424N front end)

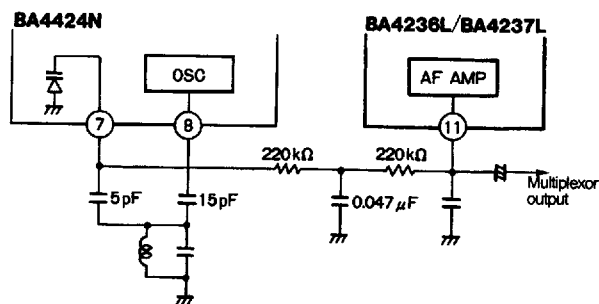
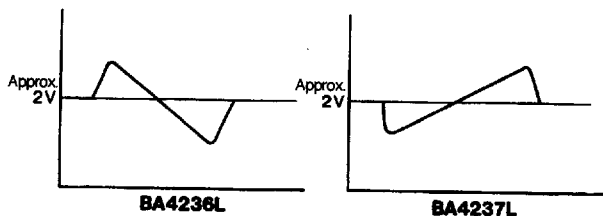

Figure 30 S-curves (typical)



Coil specifications

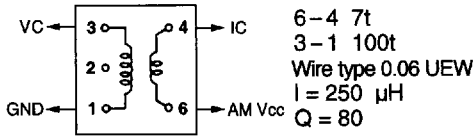

Figure 31 T₁: AM OSC 2157-2239-295 (SUMIDA)

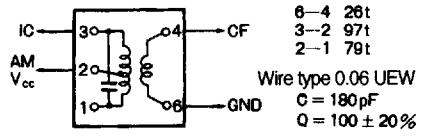

Figure 32 T₂: AM IFT (455 kHz) 2150-2173-157 (SUMIDA)

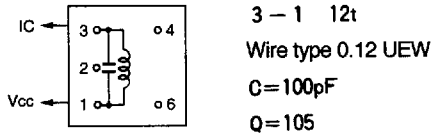

Figure 33 T₃: FM DET (10.7 MHz) 4153-409-090 (SUMIDA)

Electrical characteristic curves

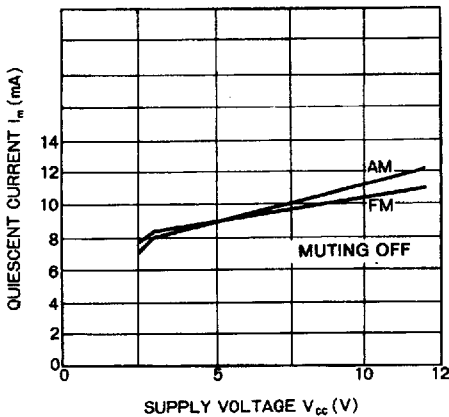

Figure 34

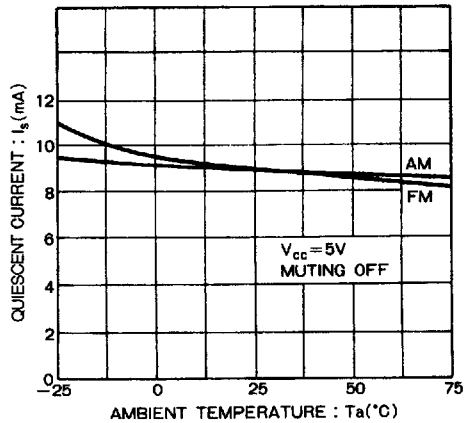

Figure 35

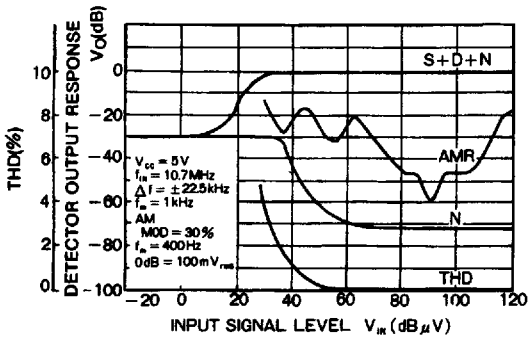

Figure 36 (FM)

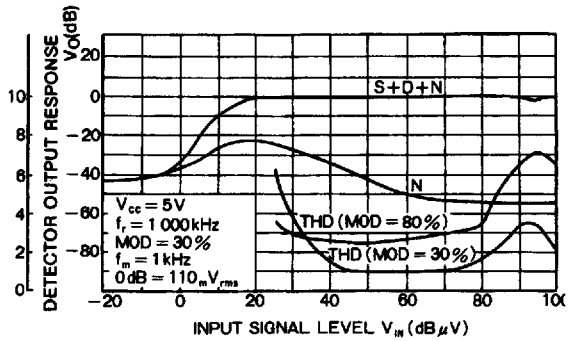

Figure 37 (AM)

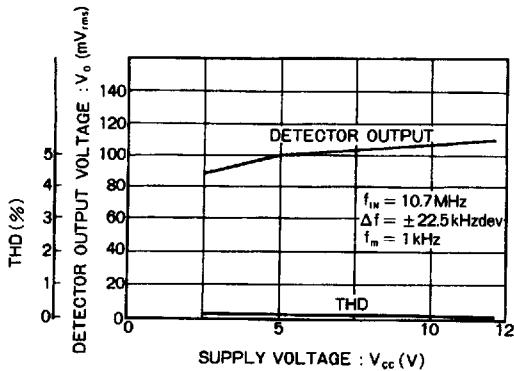

Figure 38 (FM)

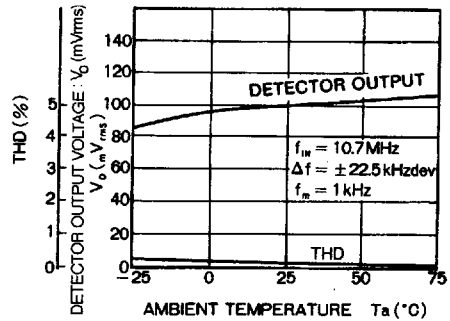

Figure 39 (FM)

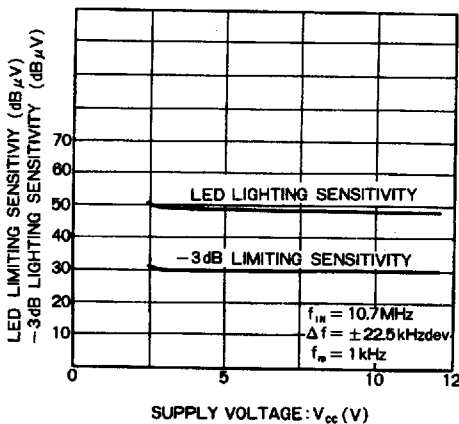

Figure 40 (FM)

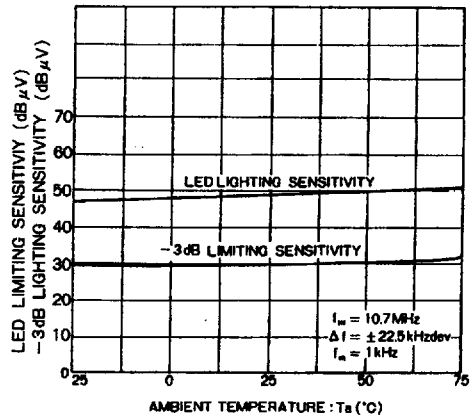

Figure 41 (FM)

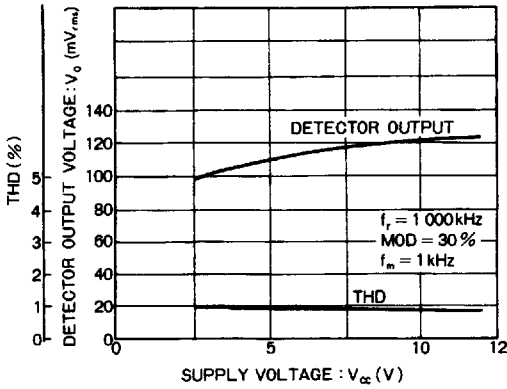

Figure 42 (AM)

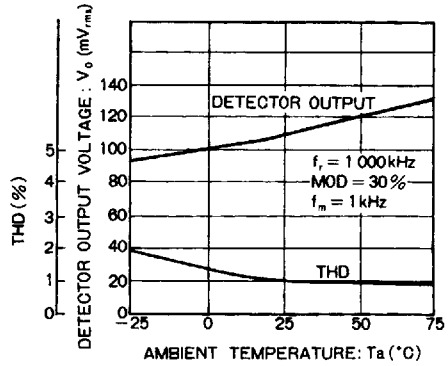

Figure 43 (AM)

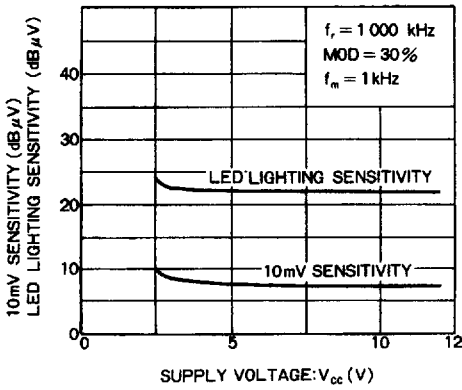

Figure 44 (AM)

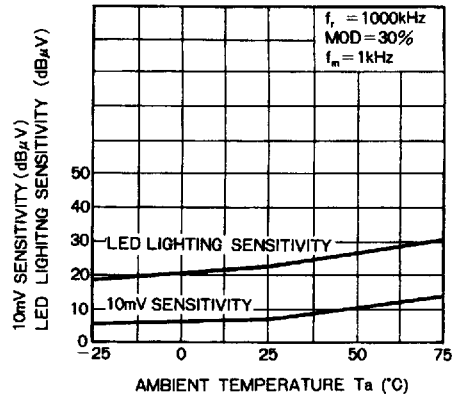

Figure 45 (AM)