

Reversible motor driver

BA6246N / BA6247 / BA6247N / BA6247FP-Y

The BA6246N, BA6247, BA6247N and BA6247FP-Y are monolithic ICs incorporating two reversible-motor drivers. The ICs differ in the control logic and output mode.

● Features

- 1) Two reversible-motor drivers in each unit.
- 2) Built-in thermal shutdown circuit.
- 3) Output voltage can be set arbitrarily.
- 4) Available in a compact SIP10pin package (BA6246N, BA6247N) or a HSIP10pin package with radiation fins (BA6247).
- 5) Available in a HSOP25pin surface-mount package (BA6247FP-Y).

● Block diagram

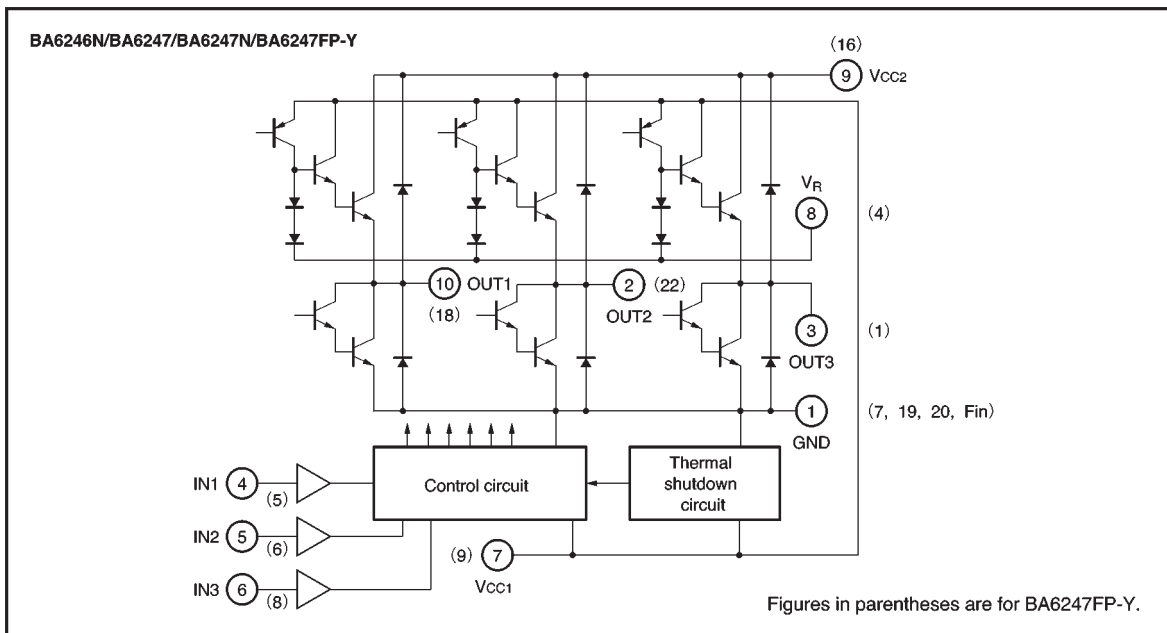

●Control pin equivalent circuits

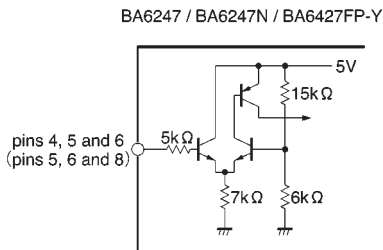
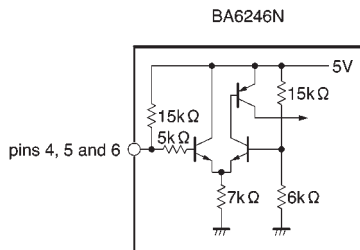

Figures in parentheses are for BA6247FP-Y.

Fig.1

●Input / output truth table

Input			Output					
Common to all units			BA6246N			BA6247/BA6247N/BA6247FP-Y		
IN1	IN2	IN3	OUT1	OUT2	OUT3	OUT1	OUT2	OUT3
L	L	L	L	L	L	L	L	L
		H	L	L	L	L	L	L
H	L	L	H	L	OPEN	H	L	OPEN
H	L	H	L	H	OPEN	L	H	OPEN
L	H	L	H	OPEN	L	H	OPEN	L
L	H	H	L	OPEN	H	L	OPEN	H
H	H	L	OPEN	OPEN	OPEN	L	L	L
		H	OPEN	OPEN	OPEN	L	L	L

●Absolute maximum ratings (Ta = 25°C)

Parameter	Symbol	Limits			Unit
		BA6246N BA6247N	BA6247	BA6247FP-Y	
Power supply voltage	V _{CC}	20	20	20	V
Power dissipation	P _d	1000*1	2000*3	1450*4	mW
Operating temperature	T _{opr}	-25~+75	-25~+75	-25~+75	°C
Storage temperature	T _{stg}	-55~+125	-55~+150	-55~+150	°C
Input voltage	V _{IN}	-0.2~+6	-0.2~+6	-0.2~+6	V
Output current	I _o	1.0*2	1.0*2	1.0*2	A

*1 Reduced by 10 mW for each increase in Ta of 1°C over 25 °C.

*2 50 ms pulse with a duty ratio of 1/50.

*3 Reduced by 16.0 mW for each increase in Ta of 1°C over 25 °C.

*4 When mounted on a glass epoxy board (90 × 50 × 1.6 mm). Reduced by 11.6 mW for each increase in Ta of 1°C over 25 °C.

●Electrical characteristics (unless otherwise noted, $T_a = 25^\circ\text{C}$ and $V_{CC} = 12\text{V}$)

Parameter	Symbol	Min.	Typ.	Max.	Unit	Conditions
Operating voltage	V_{CC1}, V_{CC2}	8	—	18	V	—
Output reference voltage	V_R	—	—	18	V	—
Current dissipation	BA6246N	—	7	15	mA	$IN1=IN2=IN3= "L"$
	BA6247 / BA6247N / BA6247FP - Y	—	10	20		
Input low level voltage	V_{IL}	—	—	1.0	V	—
Input high level voltage	V_{IH}	3.5	—	—	V	—
Output low level voltage	V_{OL}	—	0.9	1.5	V	$V_R : \text{OPEN}, I_o=0.5\text{A}$
Output high level voltage	V_{OH}	10.0	10.5	—	V	$V_R : \text{OPEN}, I_o=0.5\text{A}$
Output offset voltage	V_{ofs}	-0.5	0	0.5	V	$V_R=6\text{V}, I_o=0.5\text{A}$ Difference between V_R and the output voltage
Pin 8 (pin 14) source current	$I_s (I_{14})$	0.5	0.8	1.6	mA	$V_R=6\text{V}, I_o=0.5\text{A}$

●Application examples

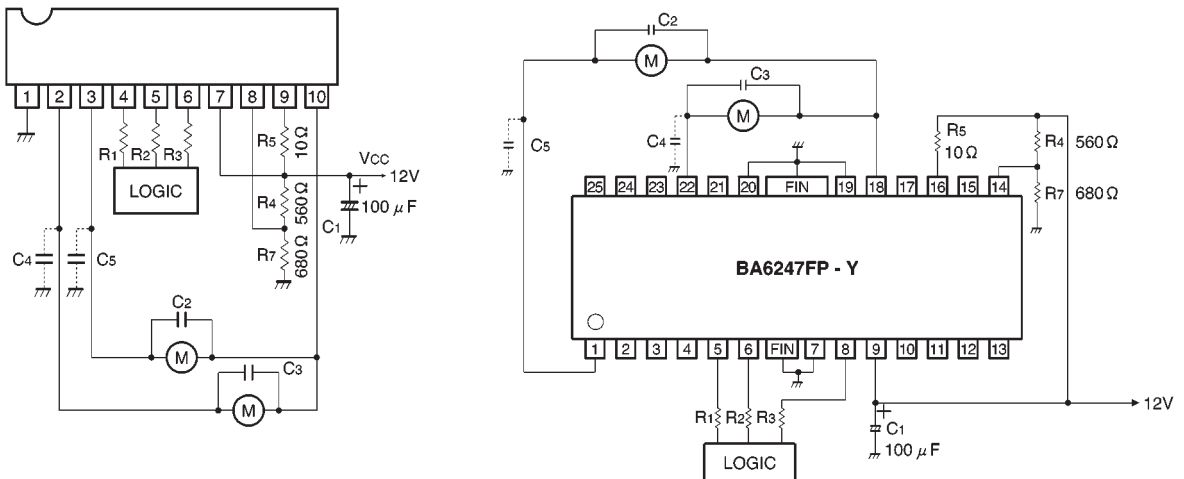

C2, C3: Capacitors for preventing parasitic oscillation. Though the optimum capacitance depends on such PCB arrangement factors as the power supply circuit, motor characteristics, and conductor foil patterns, a range of 0.011 μF is recommended.

C4, C5: Capacitors for preventing parasitic oscillation. They may or may not be required, depending on the PCB arrangement. A capacitance range of 0.01-10 μF is recommended.

Fig.2 Application circuits for a motor with ratings of 6 V and 100 mA ($V_{CC} = 12\text{V}$)

● Operation notes

(1) Input conditions

1) The input threshold voltage is positively correlated with temperature as expressed by :

$$\frac{\Delta V_{IH}}{\Delta T} \doteq +2.8\text{mV} / ^\circ\text{C}$$

$$\frac{\Delta V_{IL}}{\Delta T} \doteq +1.6\text{mV} / ^\circ\text{C} (\text{Typ.})$$

2) The input pins of the BA6246N are pulled up through a resistance of about 15k Ω (see Fig. 1). To secure the LOW level input, the interface to these pins should have a current-sink capability of at least 700 μA (5V / 15k Ω \times 2).

3) The maximum input voltage is 6V. Make sure that the input will not exceed this value. Also when the voltage V_{CC} is not applied to the IC, do not apply voltages to the input pins.

(2) Changes in motor direction

When reversing the rotational direction of a motor, make sure to go through the brake or open mode in-between the opposite directions.

The duration of brake mode should be more than the braking time, which is defined by the time required for the potential of the LOW level output pin to become less than the ground potential by the electromotive force generated when the mode is switched from rotation to brake. The duration of open mode should be 1 ms or more.

(3) Due to the effects of capacitors C_2 – C_5 , the motor that is not being driven could be momentarily driven during mode switching. Check for this problem when designing your application.

(4) It is recommendable to arrange your design so that voltage rises at V_{CC1} prior to V_{CC2} when turning on the power, and voltage falls at V_{CC1} after V_{CC2} when turning off the power.

(5) Thermal shutdown circuit

When the thermal shutdown circuit is activated, the outputs are left OPEN. The circuit is activated when the IC junction temperature rises above 170 $^\circ\text{C}$. The temperature difference between the activation and deactivation settings is about 30 $^\circ\text{C}$.

(6) The quality of these products have been carefully checked; however, use of the products with applied voltages, operating temperatures, or other parameters that exceed the absolute maximum rating given may result in the damage of the IC and the product it is used in. If the IC is damaged, the short mode and open modes cannot

be specified, so if the IC is to be used in applications where parameters may exceed the absolute maximum ratings, then be sure to incorporate fuses, or other physical safety measures.

(7) Back-rush voltage

Depending on the ambient conditions, environment, or motor characteristics, the back-rush voltage may fluctuate. Be sure to confirm that the back-rush voltage will not adversely affect the operation of the IC.

(8) Large current line

Large currents are carried by the motor power supply and motor ground for these ICs. Therefore, the layout of the pattern of the PC board and the constants of certain parameters for external components, such as the capacitor between the power supply and ground, may cause this large output current to flow back to the input pins, resulting in output oscillation or other malfunctions. To prevent this, make sure that the PC board layout and external circuit constants cause no problems with the characteristics of these ICs.

(9) Power dissipation

The power dissipation will fluctuate depending on the mounting conditions of the IC and the ambient environment. Make sure to carefully check the thermal design of the application where these ICs will be used.

(10) Power consumption

The power consumption by the IC varies widely with the power supply voltage and the output current. Give full consideration to the power dissipation rating and the thermal resistance data and transient thermal resistance data, to provide a thermal design so that none of the ratings for the IC are exceeded.

(11) ASO

Make sure that the output current and supply voltage do not exceed the ASO values.

(12) In-rush current

There are no circuits built into these ICs that prevent in-rush currents. Therefore, it is recommended to place a current limiting resistor or other physical countermeasure.

(13) Factors regarding the thermal, power supply, and motor conditions

If the potential of the output pin sways greatly and goes below the potential of ground, the operation of the IC may malfunction or be adversely affected. In such a case, place a diode between the output and ground, or other measure, to prevent this.

● Power dissipation curves

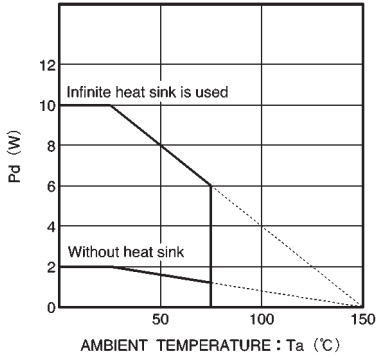

Fig.3 Power dissipation curve (BA6247)

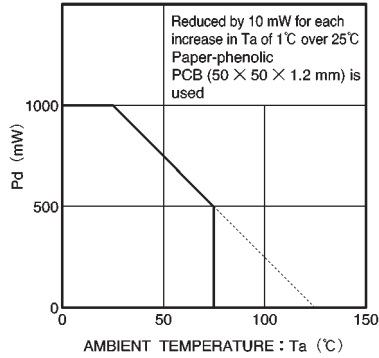

Fig.4 Power dissipation curve (BA6246N, BA6247N)

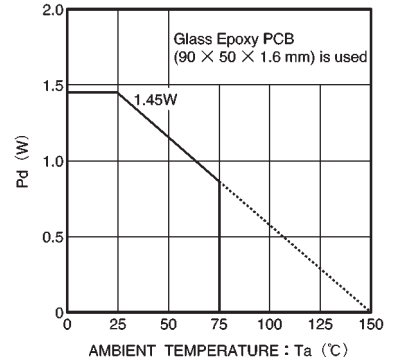

Fig.5 Power dissipation curve (BA6247FP-Y)

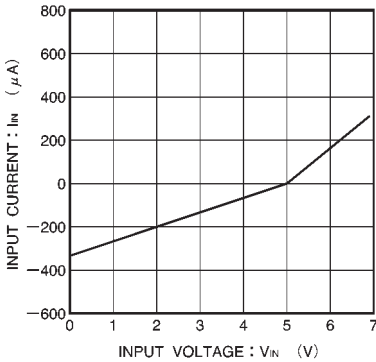

Fig.6 Input voltage vs. input current (BA6246N)

● Electrical characteristic curves

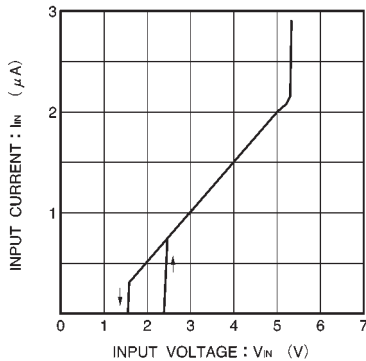

Fig.7 Input voltage vs. input current (BA6247, BA6247N, BA6247FP-Y)

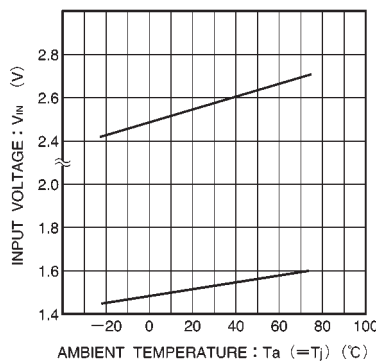

Fig.8 Input voltage vs. ambient temperature

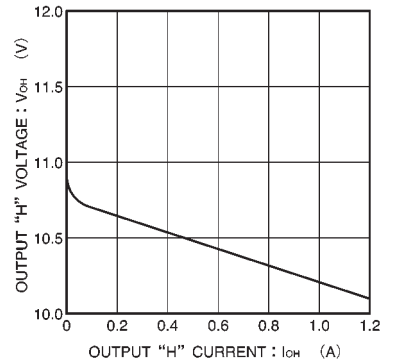

Fig.9 Output high level voltage vs. output current

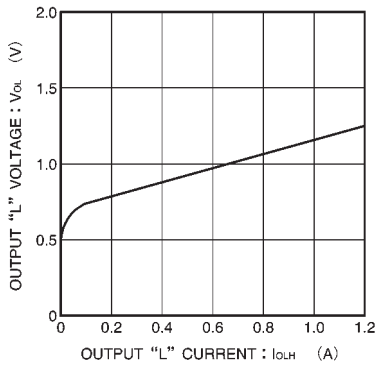

Fig.10 Output low level voltage vs. output current

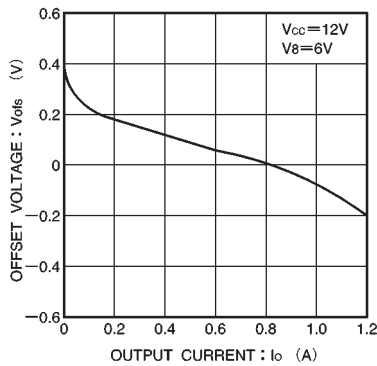

Fig.11 Offset voltage vs. output current

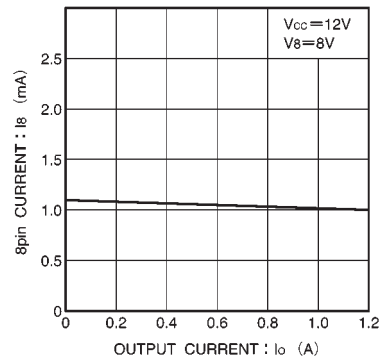

Fig.12 Pin-8 current vs. output current

● External dimensions (Units: mm)

