

7-channel Darlington transistor array

BA6250/BA6250F/BA6251/BA6251F

The BA6250, BA6250F, BA6251, and BA6251F are 7-channel transistor arrays particularly suitable for interfaces between a microcomputer in a VTR and the various ICs, or between one IC and another, and for low current drives such as LEDs.

●Features

- 1) High withstanding output voltage of 30V (max.).
- 2) Output current of 20mA max. ($V_{IN} \geq 3V$).

●Internal circuit configuration diagram

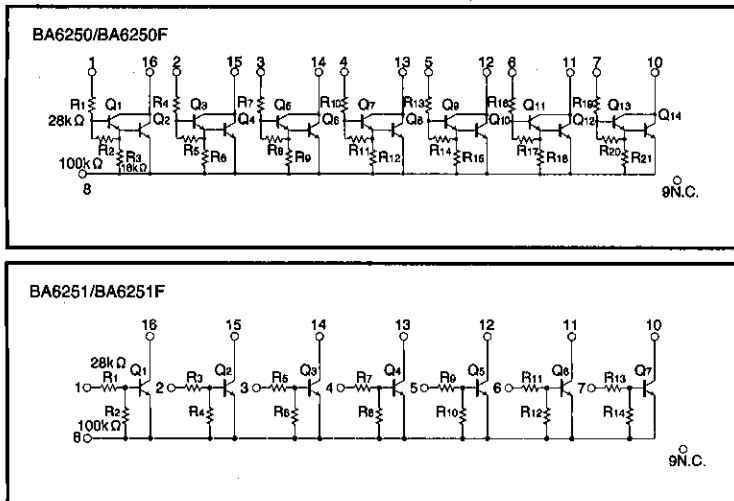

●Block diagram

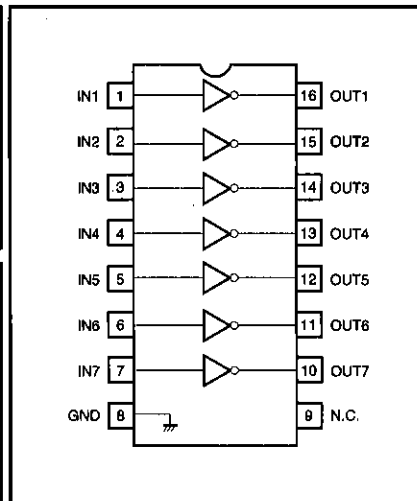

●Absolute maximum ratings ($T_a=25^\circ\text{C}$)

Parameter	Symbol	Limits	Unit
Power supply voltage	V_{CE0}	30	V
Power dissipation	P_d	500 *	mW
Operating temperature	T_{opr}	-25~75	$^\circ\text{C}$
Storage temperature	T_{stg}	-55~125	$^\circ\text{C}$
Input voltage	V_{IN}	30	V
Output current	$I_{O\ Max.}$	30	mA

* Reduced by 5mW for each increase in T_a of 1°C over 25°C .

●Electrical characteristics (unless otherwise noted, Ta=25°C, Vcc=12V)

Parameter	Symbol	Type	Min.	Typ.	Max.	Unit	Conditions	Measurement Circuit
Output power supply voltage range	V _O	BA6250 / BA6250F	—	12	28	V	—	Fig. 1
		BA6251 / BA6251F	—	12	28		—	
"H" input voltage	V _{IH}	BA6250 / BA6250F	3	—	—	V	I _{OUT} =20mA	Fig. 1
		BA6251 / BA6251F	2	—	—		I _{OUT} ≥1mA	
"L" input voltage	V _{IL}	BA6250 / BA6250F	—	—	0.6	V	I _{OUT} ≤10 μA	Fig. 2
		BA6251 / BA6251F	—	—	0.3		I _{OUT} ≤10 μA	
Output voltage	V _{OUT}	BA6250 / BA6250F	—	—	1.4	V	I _{OUT} =20mA, V _{IN} =12V	Fig. 1
Output saturation voltage	V _{CE (sat)}	BA6251 / BA6251F	—	0.3	—		I _{OUT} =10mA, V _{IN} =12V	
Output current	I _{OUT}	BA6250 / BA6250F	—	—	20	mA	V _{IN} ≥3V	Fig. 1
		BA6251 / BA6251F	—	—	20		V _{IN} ≥12V	
Input current	I _{IN}	BA6250 / BA6250F	—	—	0.6	mA	I _{OUT} =10mA, V _{IN} =12V	Fig. 1
		BA6251 / BA6251F	—	—	0.6		I _{OUT} =10mA, V _{IN} =12V	
Output leakage current	I _L	BA6250 / BA6250F	—	—	1	μA	V _{CC} =28V, V _{IN} =0V	—

●Measurement circuits

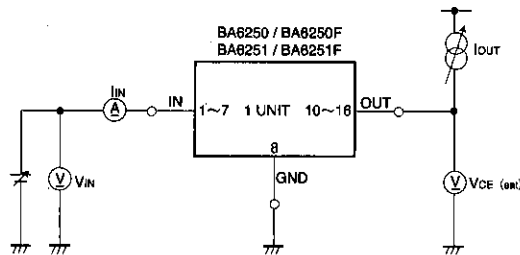

Fig.1

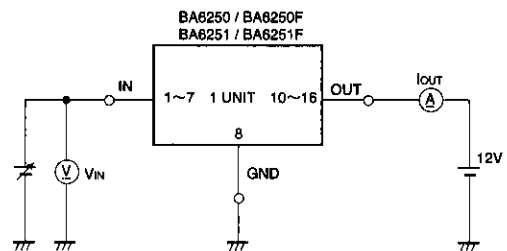

Fig.2

●External dimensions (Units: mm)

