

Dimensions (Unit: mm)

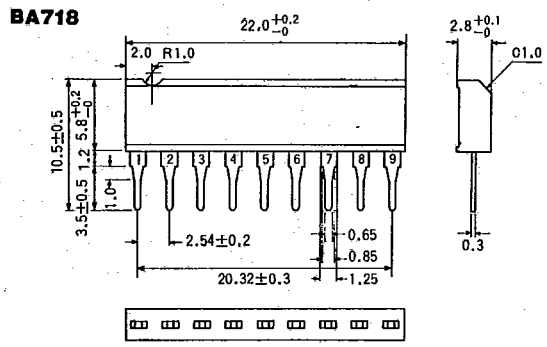

Fig. 1

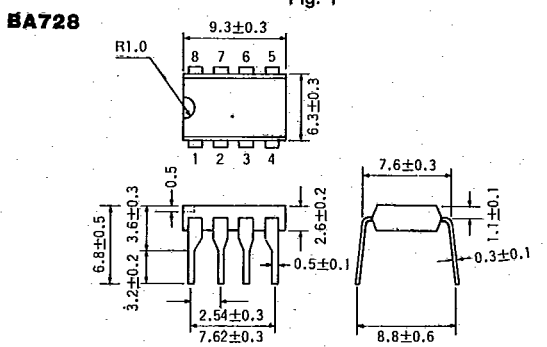

Fig. 2

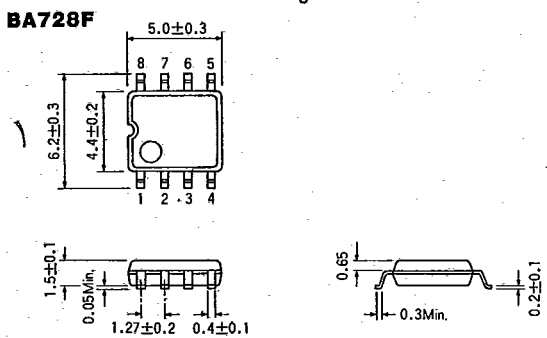

Fig. 3

The BA718, BA728, and BA728F are monolithic dual operational amplifiers; each chip contains two independent op amps with internal phase compensation. The devices feature a wide supply voltage range of 3 to 18 V (± 1.5 to ± 9 V). They can operate on a single power supply and can include a negative voltage in the common-mode input voltage range. The current consumption is small, 1.5 mA at $V_{CC}=6$ V and $V_{EE}=-6$ V, which is about a half that of the BA4558.

Features

1. Can operate on a single power supply.
2. Low power consumption.
3. Pin configuration is identical to that of the 4558 type general-purpose op amps.
4. Supply voltage range for a single power supply is 3 to 18 V.
5. Supply voltage range for dual power supply is ± 1.5 to ± 9 V.
6. Output is short-circuit protected.
7. Output stage operates in class AB to minimize crossover distortion.
8. Small input bias current of 10 nA (typ.)
9. Dual amplifiers in each package
10. Internal phase compensation

Applications

- Ground-sensing small signal amplifiers
- Control amplifiers requiring high phase margin, such as motor drivers
- Low-power, low-voltage operational amplifiers
- Capacitive load driving amplifiers

Block Diagrams

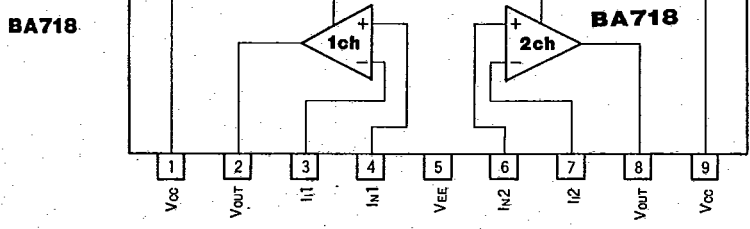

Fig. 4

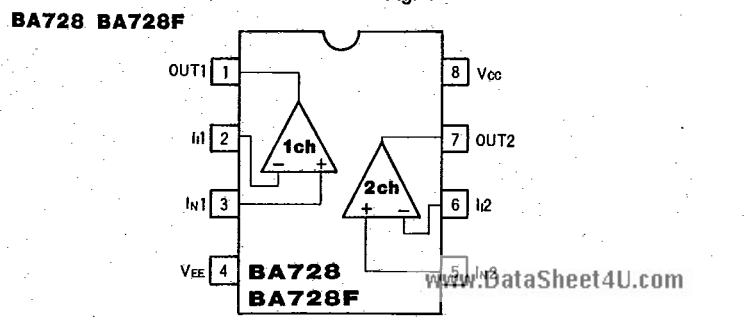

Fig. 5

Circuit Diagram

www.DataSheet4U.com

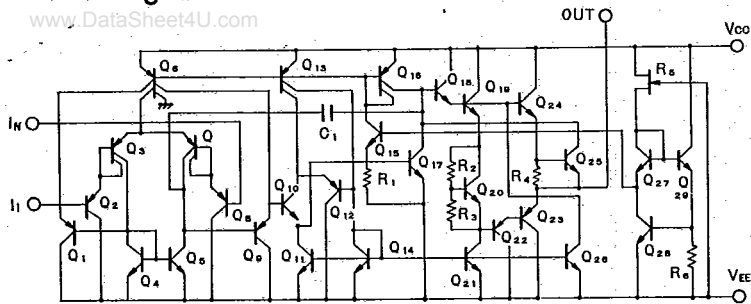

Fig. 6

Absolute Maximum Ratings (Ta=25°C)

Parameter	Symbol	Limits	Unit
Supply voltage	V _{CC}	18	V
Differential input voltage	V _{ID}	18	V
Common-mode input voltage range	V _{ICM}	-0.3~18	V
Power dissipation	P _d	450*1	mW
Operating temperature range	T _{opr}	-20~75*2	°C
Storage temperature range	T _{stg}	-55~125	°C

*1 Derating is done at 4.5 mW/°C for operation above Ta=25°C.

*2 For an extended operating temperature range, consult your local ROHM representative.

Test Circuits

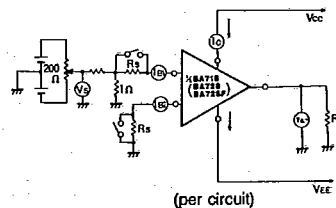

(per circuit)

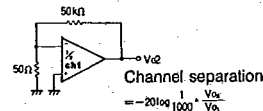

Channel separation

= -20log $\frac{1}{1000} \frac{V_{out}}{V_{in}}$

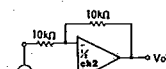

(Channel separation is measured for two channels in the same package.)

Channel separation test circuit

Fig. 7

Electrical Characteristics (Ta=25°C, V_{CC}=6V, V_{EE}=-6V)

Parameter	Symbol	Min.	Typ.	Max.	Unit	Conditions	Test circuit
Input offset voltage	V _{IO}	—	2	10	mV	—	Fig. 7
Input offset current	I _{IO}	—	1	50	nA	—	Fig. 7
Input bias current	I _B	—	10	250	nA	—	Fig. 7
Common-mode input voltage range	V _{ICM}	V _{EE}	—	V _{CC} -1.5	V	—	Fig. 7
Quiescent current	I _Q	—	1.5	3.1	mA	—	Fig. 7
Large signal voltage gain	A _V	86	100	—	dB	R _L =2kΩ	Fig. 7
Output voltage amplitude	V _O	±3.0	±4.5	—	V	R _L =2kΩ	Fig. 7
Common-mode rejection	CMR	70	90	—	dB	—	Fig. 7
Supply voltage regulation	SVR	—	30	150	μV/V	—	Fig. 7
Channel separation	S _{EP}	—	120	—	dB	—	Fig. 7
Output current (SOURCE)	I _O source	—	20	—	mA	V _{IN} ⁺ =1V, V _{IN} ⁻ =0V	Fig. 7
Output current (SINK)	I _O sink	—	20	—	mA	V _{IN} ⁻ =1V, V _{IN} ⁺ =0V	Fig. 7

*The input bias current flows out from the IC since a PNP transistor is used at the input.

Electrical Characteristic Curves

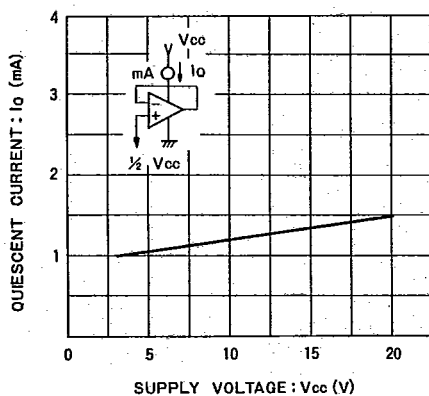

Fig. 8 Quiescent current vs. supply voltage

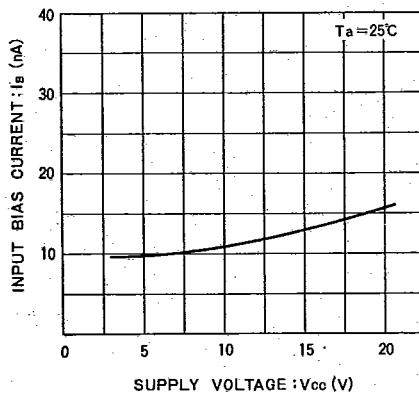

Fig. 9 Input bias current vs. supply voltage

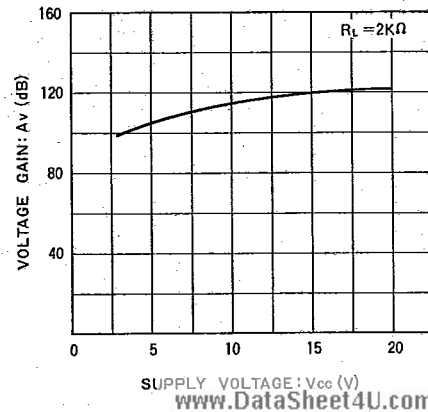

Fig. 10 Voltage gain vs. supply voltage

www.DataSheet4U.com

Electrical Characteristic Curves

www.DataSheet4U.com

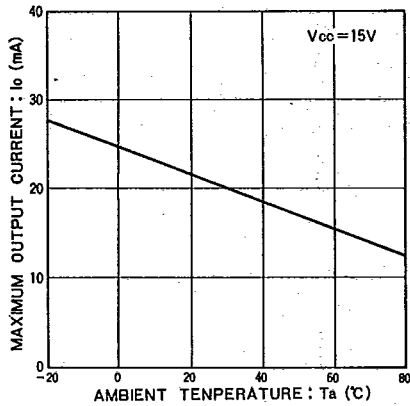

Fig. 11 Maximum output current vs. ambient temperature

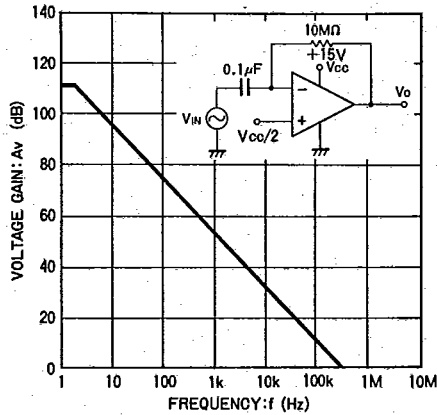

Fig. 12 Voltage gain vs. frequency

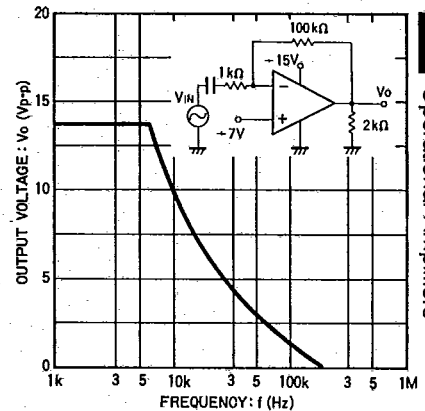

Fig. 13 Output voltage vs. frequency

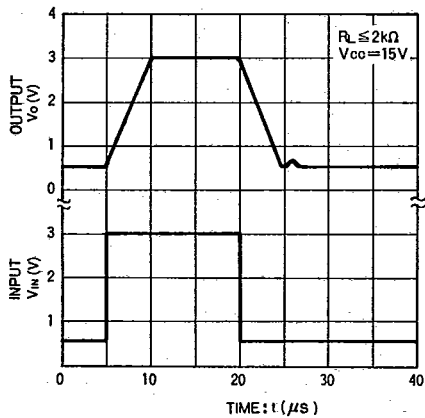

Fig. 14 Input/output vs. time

Application Examples

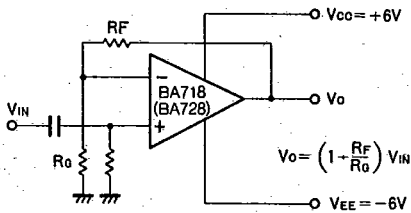

Fig. 15 Noninverting amplifier

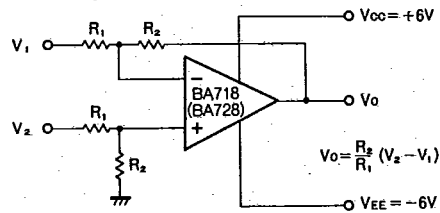

Fig. 16 Differential amplifier

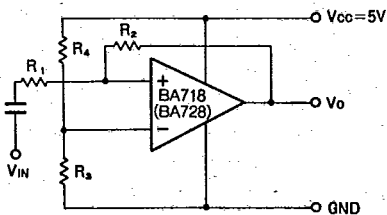

Fig. 17 AC amplifier using a single supply

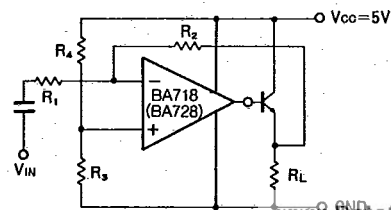

Fig. 18 Booster circuit

Operational Amplifiers