

Silicon Schottky Diodes

- For low-loss, fast-recovery, meter protection, bias isolation and clamping applications
- Integrated diffused guard ring
- Low forward voltage

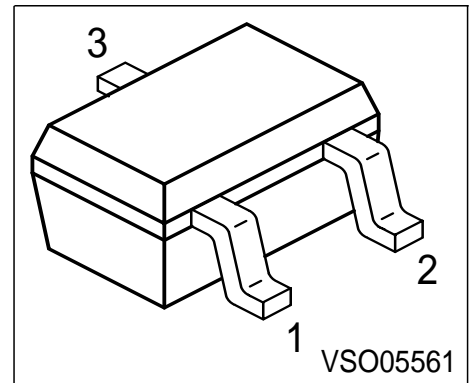

BAS125W

BAS125-04W

BAS125-05W

BAS125-06W

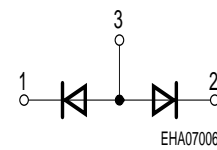
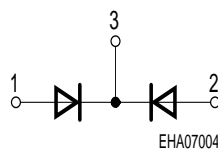
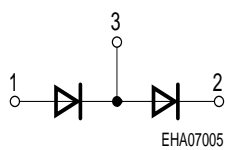
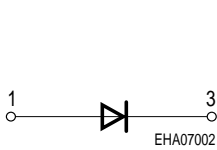

ESD: Electrostatic discharge sensitive device, observe handling precaution!

Type	Marking	Pin Configuration			Package
BAS125W	13s	1 = A	2 n.c.	3 = C	SOT323
BAS125-04W	14s	1 = A1	2 = C2	3 = C1/A2	SOT323
BAS125-05W	15s	1 = A1	2 = A2	3 = C1/2	SOT323
BAS125-06W	16s	1 = C1	2 = C2	3 = A1/2	SOT323

Maximum Ratings

Parameter	Symbol	Value	Unit
Diode reverse voltage	V_R	25	V
Forward current	I_F	100	mA
Surge forward current ($t < 100\mu s$)	I_{FSM}	500	
Total power dissipation BAS125W, $T_S = 93\text{ }^\circ\text{C}$	P_{tot}	250	mW
BAS 125-04W...06W, $T_S = 84\text{ }^\circ\text{C}$	P_{tot}	250	
Junction temperature	T_j	150	$^\circ\text{C}$
Operating temperature range	T_{op}	-55 ... 150	
Storage temperature	T_{stg}	-55 ... 150	

Thermal Resistance

Junction - soldering point ¹⁾	R_{thJS}	Value	Unit
BAS125W		≤ 230	K/W
BAS125-04W...06W		≤ 265	

¹For calculation of R_{thJA} please refer to Application Note Thermal Resistance

Electrical Characteristics at $T_A = 25^\circ\text{C}$, unless otherwise specified.

Parameter	Symbol	Values			Unit
		min.	typ.	max.	
DC characteristics					
Reverse current $V_R = 20\text{ V}$ $V_R = 25\text{ V}$	I_R	- -	- -	100 150	nA
Forward voltage $I_F = 1\text{ mA}$ $I_F = 10\text{ mA}$ $I_F = 35\text{ mA}$	V_F	- - -	385 530 800	400 650 950	mV
AC characteristics					
Diode capacitance $V_R = 0\text{ V}$, $f = 1\text{ MHz}$	C_T	-	-	1.1	pF
Differential forward resistance $I_F = 5\text{ mA}$, $f = 10\text{ kHz}$	R_f	-	16	-	Ω

Forward current $I_F = f(T_S)$

BAS125W

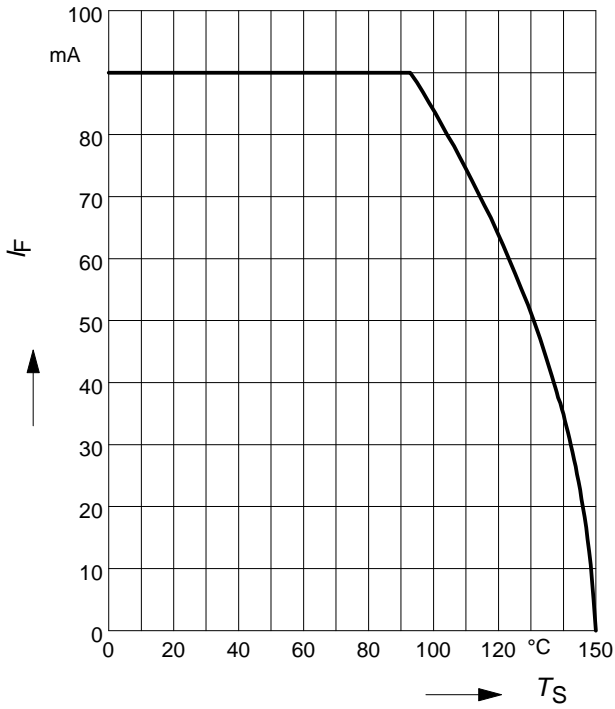

Permissible Pulse Load $R_{thJS} = f(t_p)$

BAS125W

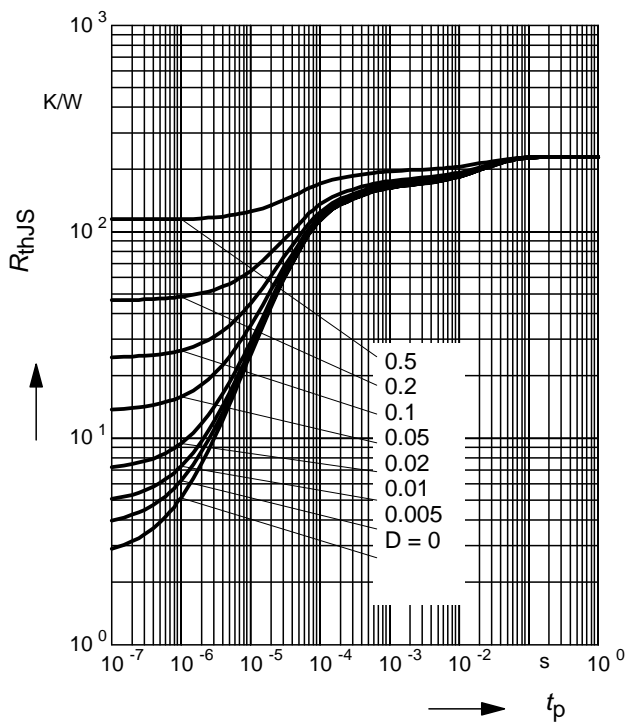

Permissible Pulse Load

$I_{Fmax} / I_{FDC} = f(t_p)$

BAS125W

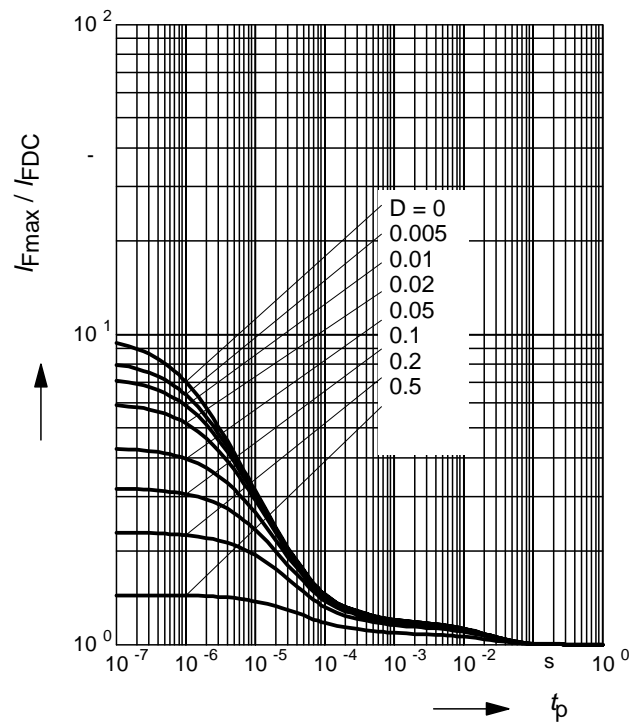

Forward current $I_F = f(T_S)$

BAS125-04W...06W (I_F per diode)

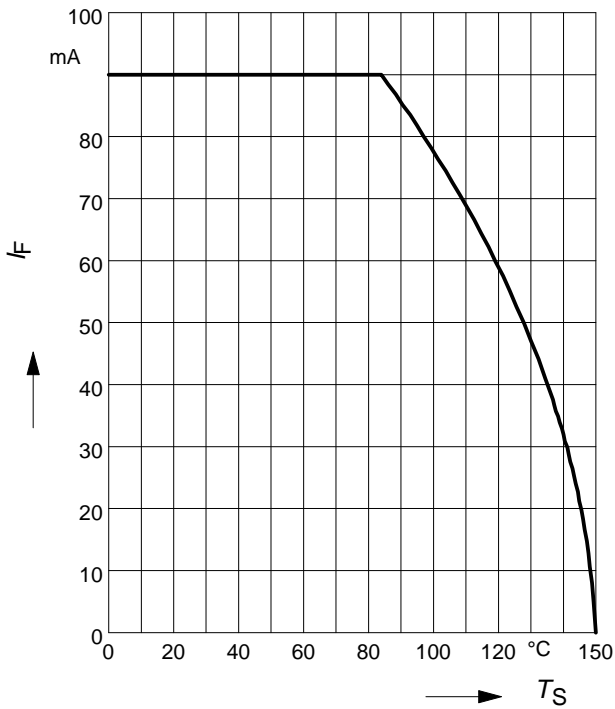

Permissible Pulse Load $R_{thJS} = f(t_p)$

BAS125-04W...06W

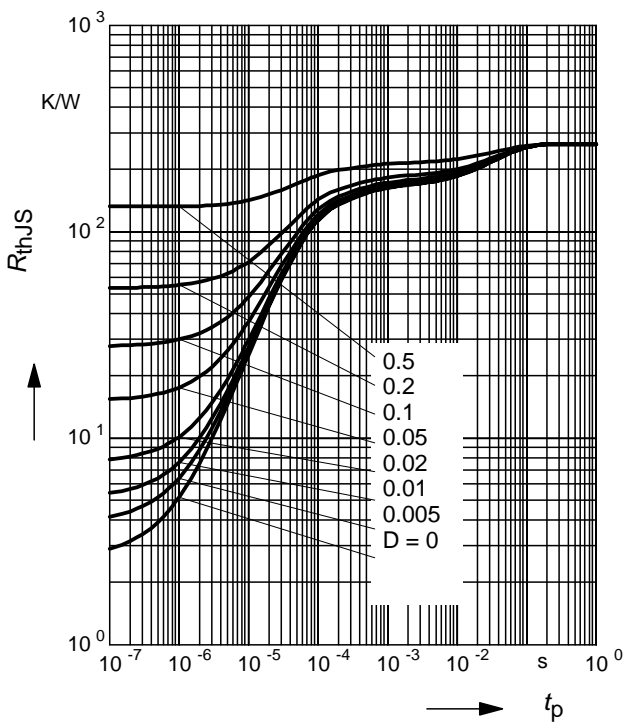

Permissible Pulse Load

$I_{Fmax} / I_{FDC} = f(t_p)$

BAS125-04W...06W

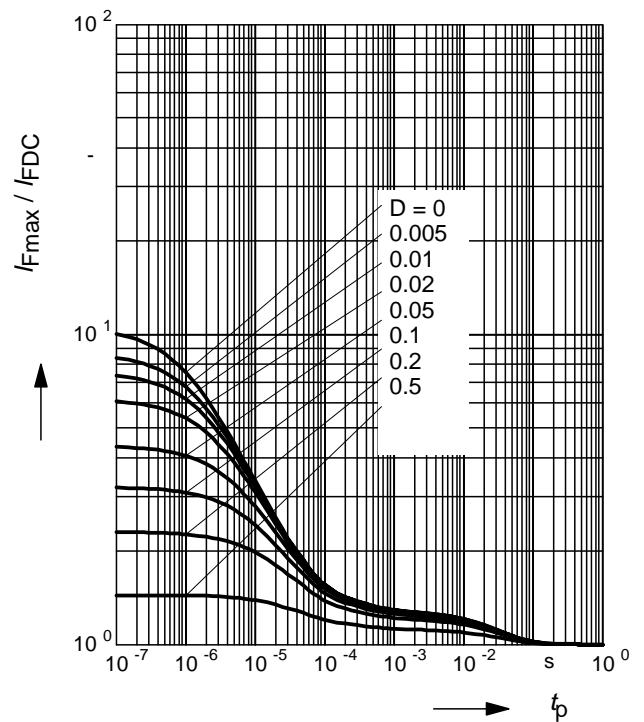

Forward current $I_F = f(V_F)$

$T_A =$ Parameter

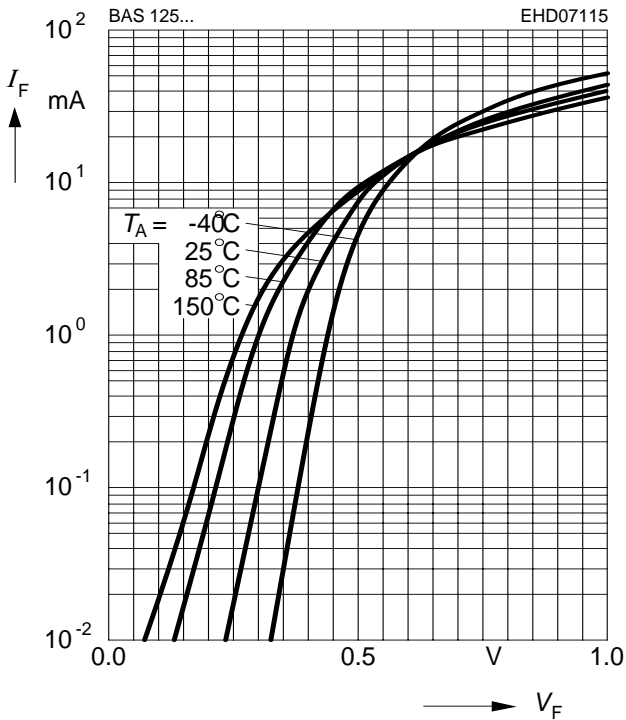

Diode capacitance $C_T = f(V_R)$

$f = 1\text{MHz}$

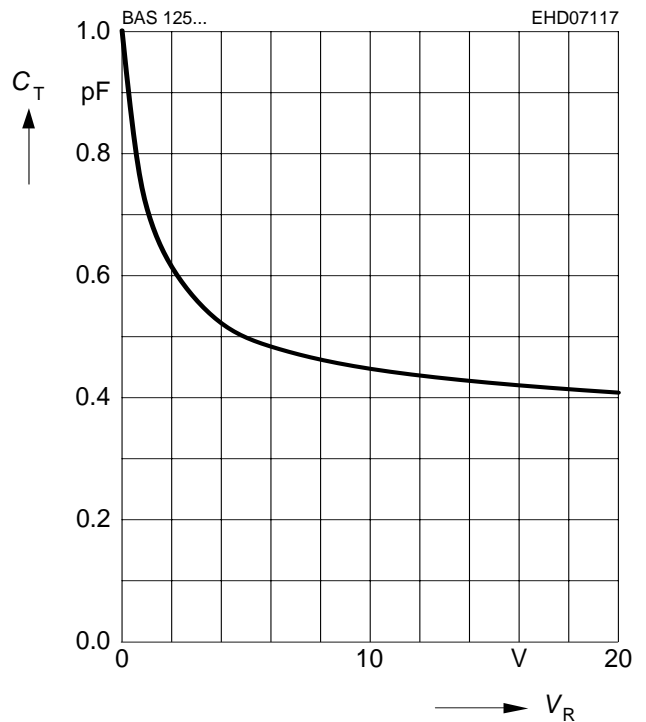

Reverse current $I_R = f(V_R)$

$T_A =$ Parameter

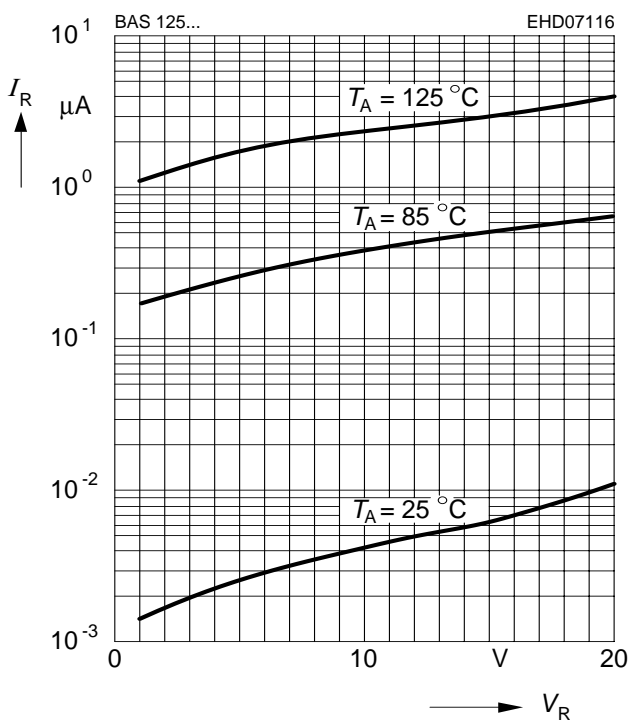

Differential forward resistance $r_f = f(I_F)$

$f = 10\text{ kHz}$

