

Features

- High Conductance
- Fast Switching
- Surface Mount Package Ideally Suited for Automatic Insertion
- For General Purpose Switching Applications
- Plastic Material – UL Recognition Flammability Classification 94V-0

Mechanical Data

- Case: SOT-23, Molded Plastic
- Terminals: Plated Leads Solderable per MIL-STD-202, Method 208
- Polarity: See Diagram
- Weight: 0.008 grams (approx.)
- Mounting Position: Any
- Marking: Device Code, See Page 3
- **Lead Free: For RoHS / Lead Free Version, Add “-LF” Suffix to Part Number, See Page 4**

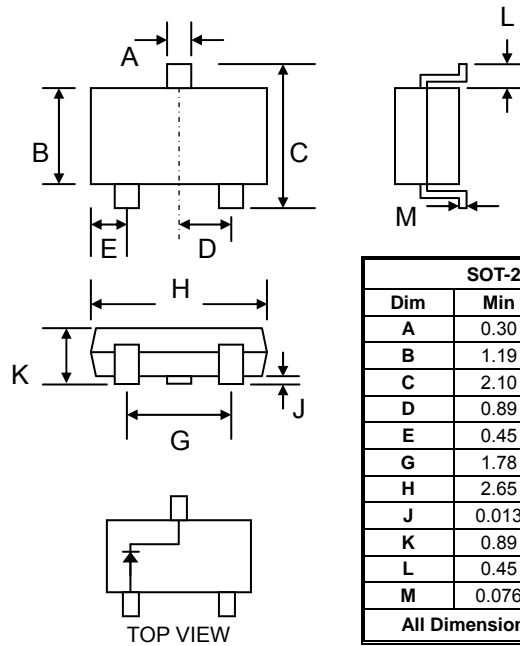

SOT-23		
Dim	Min	Max
A	0.30	0.50
B	1.19	1.40
C	2.10	2.50
D	0.89	1.05
E	0.45	0.61
G	1.78	2.05
H	2.65	3.05
J	0.013	0.15
K	0.89	1.10
L	0.45	0.61
M	0.076	0.178
All Dimensions in mm		

Maximum Ratings @ $T_A=25^{\circ}\text{C}$ unless otherwise specified

Characteristic	Symbol	BAS19	BAS20	BAS21	Unit
Peak Repetitive Reverse Voltage	V_{RRM}	120	200	250	V
Working Peak Reverse Voltage DC Blocking Voltage	V_{RWM} V_R	100	150	200	V
Forward Continuous Current	I_F	200			mA
Non-Repetitive Peak Forward Surge Current	I_{FSM}	2.5 0.5			A
	@ $t = 1.0\mu\text{s}$ @ $t = 1.0\text{s}$				
Operating and Storage Temperature Range	T_J, T_{STG}	-55 to +150			$^{\circ}\text{C}$

Thermal Characteristics

Characteristic	Symbol	BAS19	BAS20	BAS21	Unit
Power Dissipation (Note 1)	P_D	250			mW
Thermal Resistance, Junction to Ambient (Note 1)	R_{JA}	500			$^{\circ}\text{C}/\text{W}$

Note: 1. Mounted on FR-4 PC board with minimum recommended pad layout.

Electrical Characteristics @ $T_A=25^\circ\text{C}$ unless otherwise specified

Characteristic	Symbol	BAS19	BAS20	BAS21	Unit
Reverse Breakdown Voltage @ $I_R = 100\mu\text{A}$	$V_{(BR)}$	120	200	250	V
Forward Voltage Drop @ $I_F = 100\text{mA}$ @ $I_F = 200\text{mA}$	V_{FM}		1.0 1.25		V
Peak Reverse Leakage Current @ Rated V_R , $T_J = 25^\circ\text{C}$ @ Rated V_R , $T_J = 150^\circ\text{C}$	I_{RM}		100 100		nA μA
Diode Capacitance ($V_R = 0\text{V}$, $f = 1.0\text{MHz}$)	C_D		5.0		pF
Reverse Recovery Time ($I_F = I_R = 30\text{mA}$, $I_{RR} = 0.1 \times I_R$, $R_L = 100\Omega$)	t_{rr}		50		nS

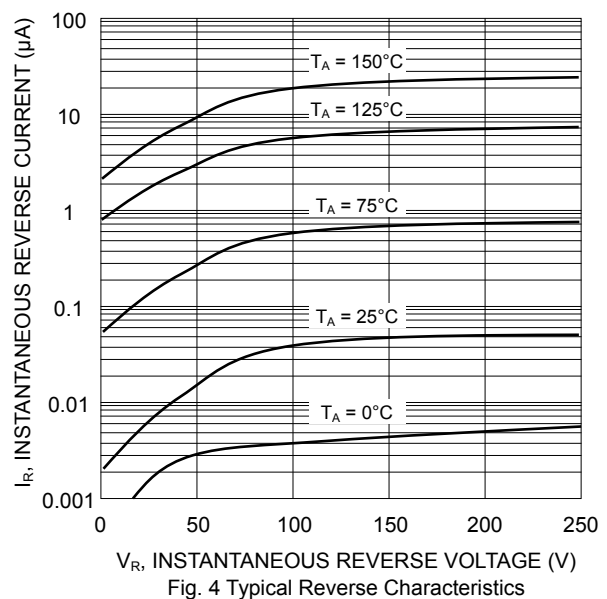
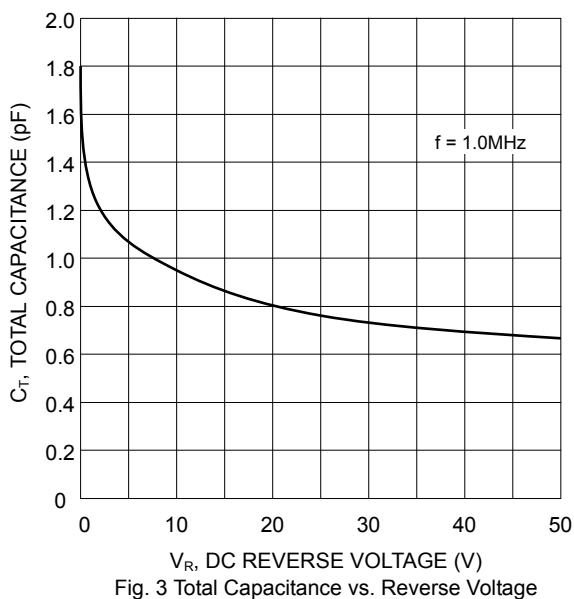
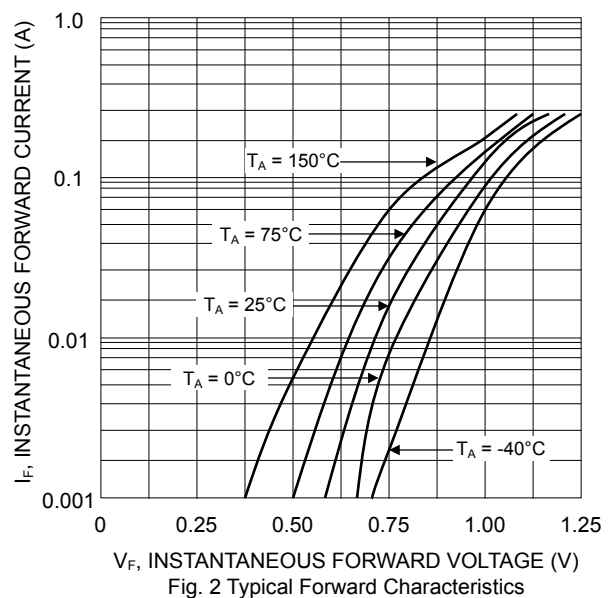
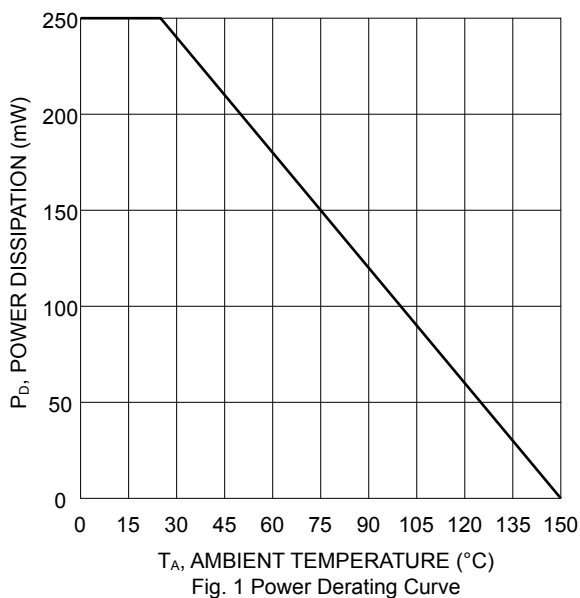

MARKING INFORMATION

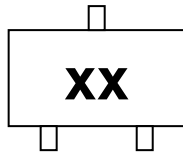

xx = Device Code, See Table Below

Mfg Site	BAS19	BAS20	BAS21
TW Plant	A8	A80	A82
CN Plant	JP	JR	JS

RECOMMENDED FOOTPRINT

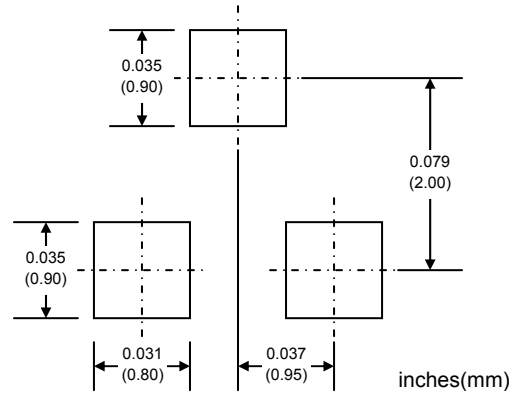

PACKAGING INFORMATION

TAPE & REEL

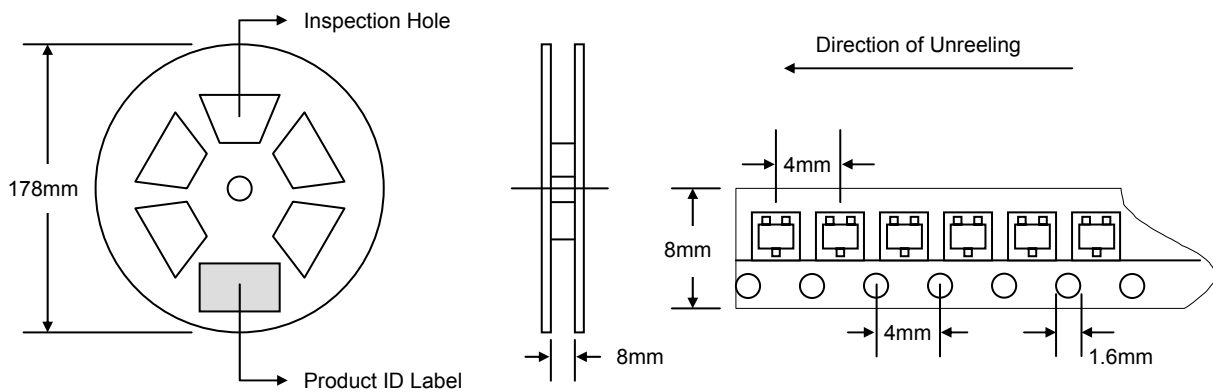

Reel Diameter (mm)	Quantity (PCS)	Inner Box Size L x W x H (mm)	Quantity (PCS)	Carton Size L x W x H (mm)	Quantity (PCS)	Approx. Gross Weight (KG)
178	3,000	187 x 187 x 65	15,000	390 x 240 x 420	150,000	10.0

Note: 1. Anti-static plastic reel, white, water clear or blue color. Inspection hole might be varied in different alignment.
2. Components are packed in accordance with EIA standard 481-1 and 481-2.

ORDERING INFORMATION

Product No.	Package Type	Shipping Quantity
BAS19-T1	SOT-23	3000/Tape & Reel
BAS20-T1	SOT-23	3000/Tape & Reel
BAS21-T1	SOT-23	3000/Tape & Reel

1. Shipping quantity given is for minimum packing quantity only. For minimum order quantity, please consult the Sales Department.
2. **To order RoHS / Lead Free version (with Lead Free finish), add “-LF” suffix to part number above. For example, BAS19-T1-LF.**

WON-TOP ELECTRONICS and  are registered trademarks of Won-Top Electronics Co., Ltd (WTE). WTE has checked all information carefully and believes it to be correct and accurate. However, WTE cannot assume any responsibility for inaccuracies. Furthermore, this information does not give the purchaser of semiconductor devices any license under patent rights to manufacturer. WTE reserves the right to change any or all information herein without further notice.

WARNING: DO NOT USE IN LIFE SUPPORT EQUIPMENT. WTE power semiconductor products are not authorized for use as critical components in life support devices or systems without the express written approval.

Won-Top Electronics Co., Ltd.
No. 44 Yu Kang North 3rd Road,
Chine Chen Dist., Kaohsiung 806, Taiwan
Phone: 886-7-822-5408 or 886-7-822-5410
Fax: 886-7-822-5417
Email: sales@wontop.com
Internet: <http://www.wontop.com>

We power your everyday.