

SOT-23



Features

- ✧ Low turn-on voltage
- ✧ Fast switching
- ✧ PN junction guard Ring for transient

Mechanical Data

- ✧ Case: SOT-23, Molded plastic
- ✧ Marking & Polarity: See diagram below
- ✧ Weight: 0.008 grams (approx.)

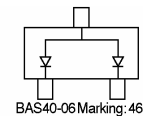
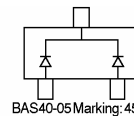
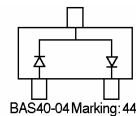
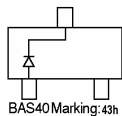
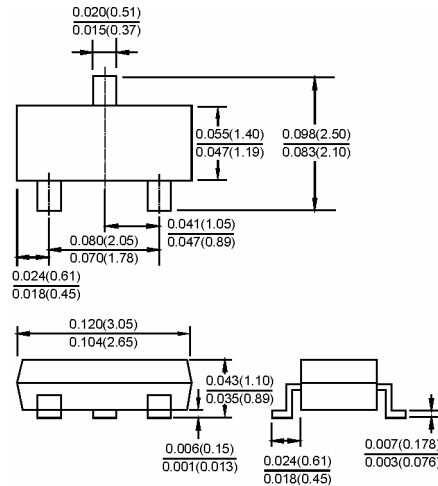

Maximum Ratings $T_A=25^{\circ}\text{C}$ unless otherwise specified

Type Number	Symbol	BAS40	Units
Peak Repetitive Reverse Voltage	VRRM	40	V
Working Peak Reverse Voltage	VRWM		
DC Blocking Voltage	VR		
Forward Continuous Current (Note 1)	IFM	200	mA
Non-Repetitive Peak Forward Surge Current @ $t \leq 1.0\text{s}$	IFSM	600	mA
Power Dissipation (Note 1)	Pd	200	mW
Thermal Resistance Junction to Ambient Air (Note 1)	$R_{\theta JA}$	357	$^{\circ}\text{C}/\text{W}$
Operating Junction Temperature Range	T_J	-55 to + 125	$^{\circ}\text{C}$
Storage Temperature Range	T_{STG}	-65 to + 150	$^{\circ}\text{C}$

Electrical Characteristics

Type Number	Symbol	Min	Typ	Max	Units
Reverse Breakdown Voltage $I_R=10\mu\text{A}$	$V_{(BR)}$	40	-	-	V
Reverse Leakage Current $t_p < 300\mu\text{s}$, $V_R=30\text{V}$	I_R	--	20	200	nA
Forward Voltage Drop $t_p=300\mu\text{s}$, $I_F=1.0\text{mA}$ $t_p < 300\mu\text{s}$, $I_F=40\text{mA}$	V_F	--	-	380 1000	mV
Junction Capacitance $V_R=0$, $f=1.0\text{MHz}$	C_j	-	4.0	5.0	pF
Reverse Recovery Time (Note 2)	t_{rr}	-	--	5.0	nS

Notes: 1. Valid Provided that Terminals are Kept at Ambient Temperature.

2. Reverse Recovery Test Conditions: $I_F=I_R=10\text{mA}$, $I_{rr}=1.0\text{mA}$, $R_L=100\Omega$.

RATINGS AND CHARACTERISTIC CURVES (BAS40 / -04 / -05 / -06)

FIG.1- POWER DERATING CURVE

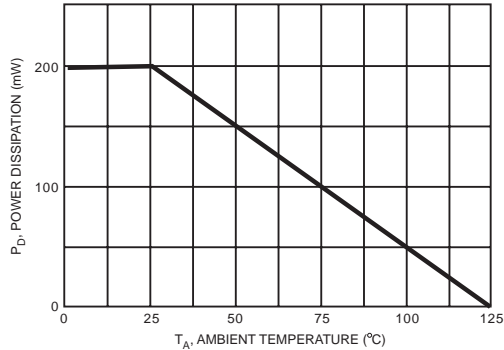

FIG.2- MAXIMUM NON-REPETITIVE PEAK FORWARD SURGE CURRENT PER LEG

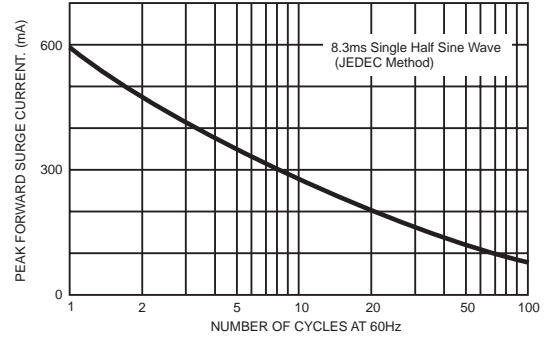

FIG.3- TYPICAL FORWARD CHARACTERISTICS

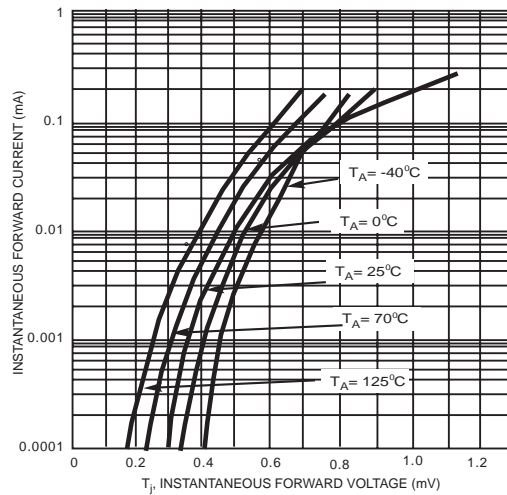

FIG.4- TYPICAL REVERSE CHARACTERISTICS

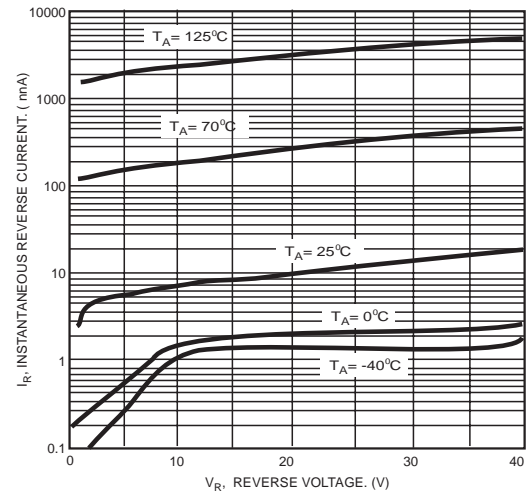

FIG.5- TYPICAL TOTAL CAPACITANCE VS REVERSE VOLTAGE

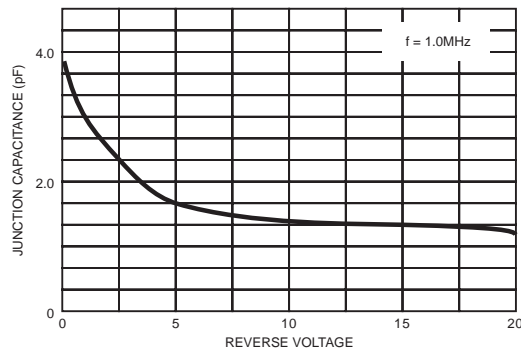

FIG.6- TYPICAL TRANSIENT THERMAL CHARACTERISTICS

