

### Features

- Single and Dual Diode
- Low Forward Voltage
- PN Junction Guard Ring for Transient and ESD Protection
- For General Purpose Switching Applications
- Plastic Material – UL Recognition Flammability Classification 94V-0

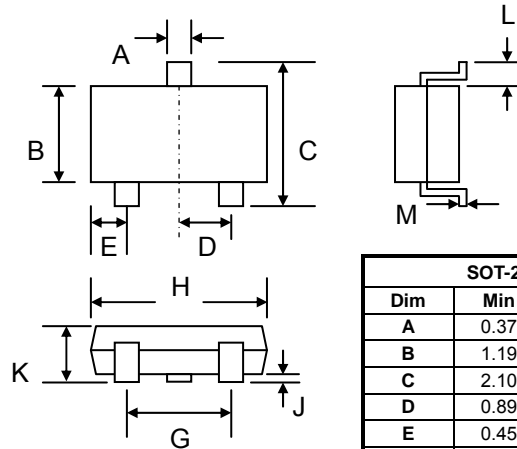

SOT-23		
Dim	Min	Max
A	0.37	0.51
B	1.19	1.40
C	2.10	2.50
D	0.89	1.05
E	0.45	0.61
G	1.78	2.05
H	2.65	3.05
J	0.013	0.15
K	0.89	1.10
L	0.45	0.61
M	0.076	0.178
All Dimensions in mm		

### Mechanical Data

- Case: SOT-23, Molded Plastic
- Terminals: Plated Leads Solderable per MIL-STD-202, Method 208
- Polarity: See Diagrams Below
- Weight: 0.008 grams (approx.)
- Marking: Device Code, See Page 3
- Mounting Position: Any
- **Lead Free: For RoHS / Lead Free Version, Add "-LF" Suffix to Part Number, See Page 4**

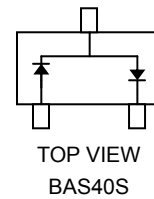
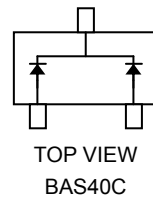
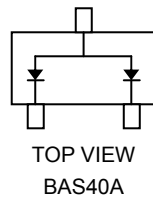
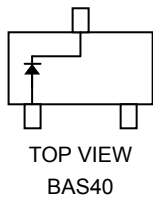

### Maximum Ratings @T<sub>A</sub>=25°C unless otherwise specified

Characteristic	Symbol	Value	Unit
Peak Repetitive Reverse Voltage Working Peak Reverse Voltage DC Blocking Voltage	V <sub>RRM</sub> V <sub>RWM</sub> V <sub>R</sub>	40	V
Forward Continuous Current	I <sub>F</sub>	200	mA
Non-Repetitive Peak Forward Surge Current @ t < 1.0s	I <sub>FSM</sub>	600	mA
Operating Temperature Range	T <sub>J</sub>	-55 to +125	°C
Storage Temperature Range	T <sub>STG</sub>	-65 to +150	°C

### Thermal Characteristics

Characteristic	Symbol	Value	Unit
Power Dissipation (Note 1)	P <sub>D</sub>	350	mW
Thermal Resistance, Junction to Ambient (Note 1)	R <sub>JA</sub>	357	°C/W

Note: 1. Mounted on FR-4 PC board with minimum recommended pad layout.

## Electrical Characteristics @ $T_A=25^\circ\text{C}$ unless otherwise specified

Characteristic	Symbol	Min.	Typ.	Max.	Unit
Reverse Breakdown Voltage @ $I_R = 10\mu\text{A}$	$V_{(BR)}$	40			V
Forward Voltage Drop @ $I_F = 1.0\text{mA}$ @ $I_F = 40\text{mA}$	$V_F$			0.38 1.00	V
Reverse Leakage Current @ $V_R = 30\text{V}$	$I_R$		20	200	nA
Diode Capacitance ( $V_R = 0\text{V}$ , $f = 1.0\text{MHz}$ )	$C_D$		4.0	5.0	pF
Reverse Recovery Time ( $I_F = I_R = 10\text{mA}$ , $I_{RR} = 0.1 \times I_R$ , $R_L = 100\Omega$ )	$t_{rr}$			5.0	nS

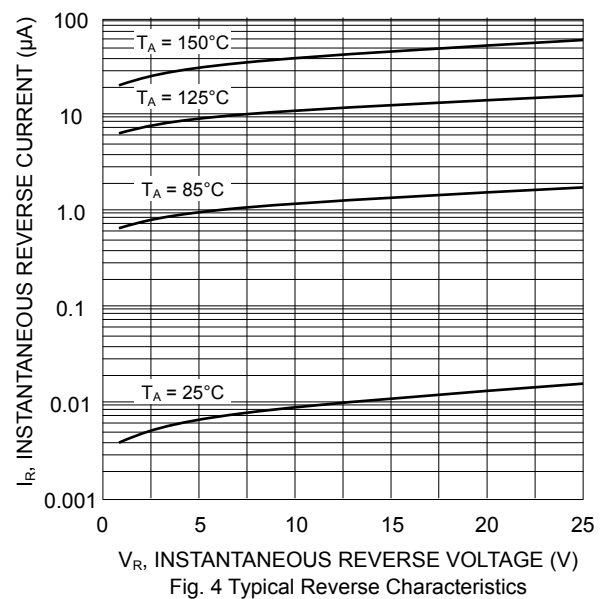
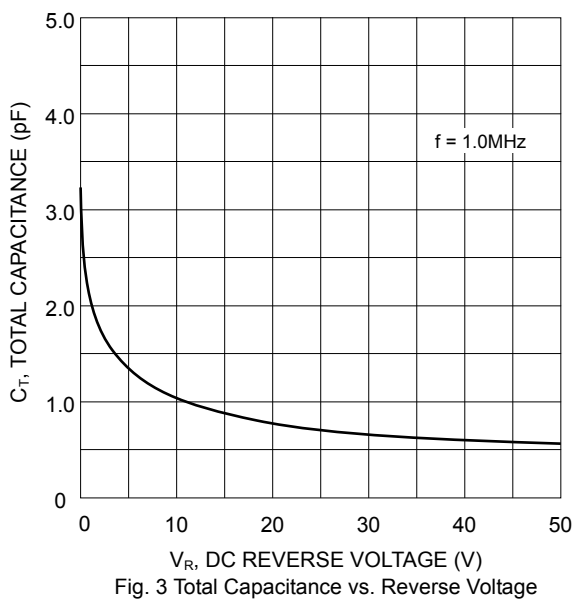
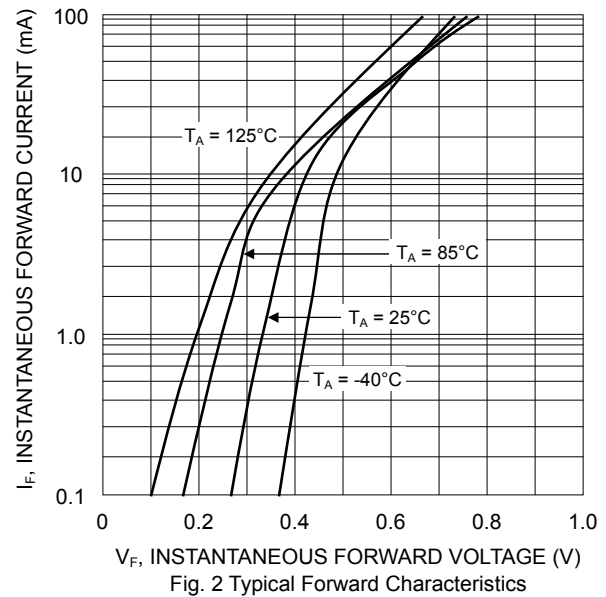
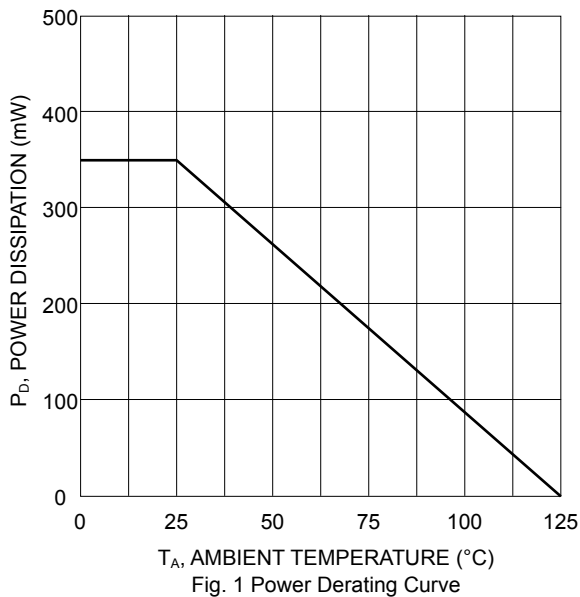

## MARKING INFORMATION

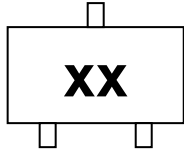

xx = Device Code, See Table Below

Mfg Site	BAS40	BAS40A	BAS40C	BAS40S
TW Plant	S40	S42	S43	S44
CN Plant	43	46	45	44

## RECOMMENDED FOOTPRINT

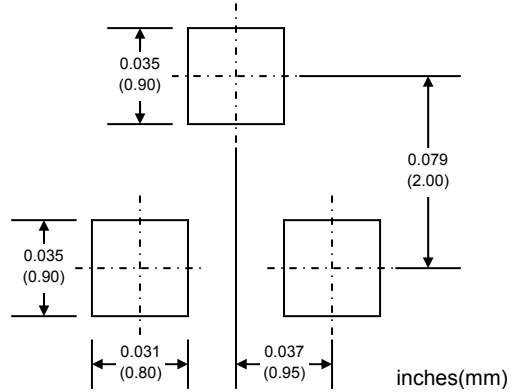

## PACKAGING INFORMATION

### TAPE & REEL

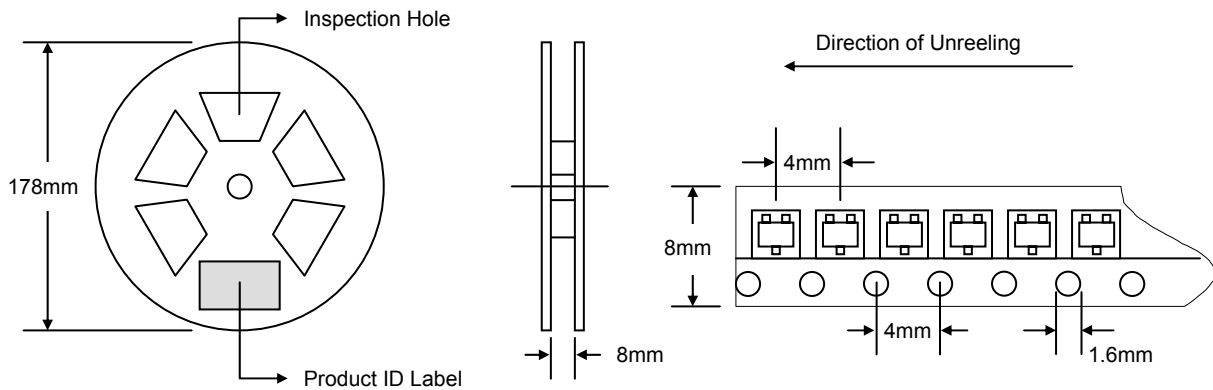

Reel Diameter (mm)	Quantity (PCS)	Inner Box Size L x W x H (mm)	Quantity (PCS)	Carton Size L x W x H (mm)	Quantity (PCS)	Approx. Gross Weight (KG)
178	3,000	187 x 187 x 65	15,000	390 x 240 x 420	150,000	10.0

**Note:** 1. Anti-static plastic reel, white, water clear or blue color. Inspection hole might be varied in different alignment.  
2. Components are packed in accordance with EIA standard 481-1 and 481-2.

## ORDERING INFORMATION

Product No.	Package Type	Shipping Quantity
BAS40-T1	SOT-23	3000/Tape & Reel
BAS40A-T1	SOT-23	3000/Tape & Reel
BAS40C-T1	SOT-23	3000/Tape & Reel
BAS40S-T1	SOT-23	3000/Tape & Reel

1. Shipping quantity given is for minimum packing quantity only. For minimum order quantity, please consult the Sales Department.
2. **To order RoHS / Lead Free version (with Lead Free finish), add "-LF" suffix to part number above. For example, BAS40-T1-LF.**

WON-TOP ELECTRONICS and  are registered trademarks of Won-Top Electronics Co., Ltd (WTE). WTE has checked all information carefully and believes it to be correct and accurate. However, WTE cannot assume any responsibility for inaccuracies. Furthermore, this information does not give the purchaser of semiconductor devices any license under patent rights to manufacturer. WTE reserves the right to change any or all information herein without further notice.

**WARNING:** DO NOT USE IN LIFE SUPPORT EQUIPMENT. WTE power semiconductor products are not authorized for use as critical components in life support devices or systems without the express written approval.

**Won-Top Electronics Co., Ltd.**  
No. 44 Yu Kang North 3rd Road,  
Chine Chen Dist., Kaohsiung 806, Taiwan  
**Phone:** 886-7-822-5408 or 886-7-822-5410  
**Fax:** 886-7-822-5417  
**Email:** sales@wontop.com  
**Internet:** <http://www.wontop.com>

*We power your everyday.*