

SOT-323 Plastic-Encapsulate Diodes

BAS40W/-04/-05/-06 SCHOTTKY BARRIER DIODE

FEATURES

- Low Forward Voltage
- Fast Switching

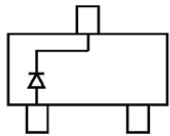
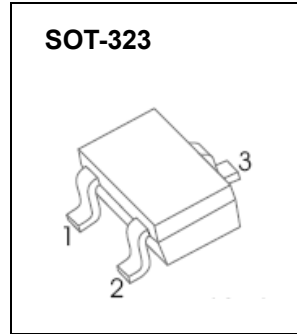

BAS40W MARKING: 43•

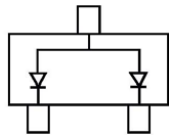

BAS40W-06 MARKING: 46

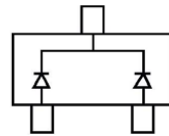

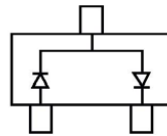

BAS40W-05 MARKING: 45

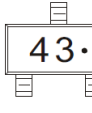
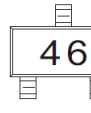

BAS40W-04 MARKING: 44

MARKING:

| BAS40W | BAS40W-06 | BAS40W-05 | BAS40W-04 |
|---|--|--|--|
|  |  |  |  |

Solid dot = Green molding compound device, if none, the normal device.

Maximum Ratings @Ta=25°C

| Parameter | Symbol | Limit | Unit |
|--|-----------------|----------|------|
| Peak repetitive peak reverse voltage | V_{RRM} | 40 | V |
| Working peak reverse voltage | V_{RWM} | | |
| DC blocking voltage | V_R | | |
| Forward continuous current | I_{FM} | 200 | mA |
| Power dissipation | P_D | 150 | mW |
| Thermal resistance junction to ambient | $R_{\theta JA}$ | 667 | °C/W |
| Junction temperature | T_J | 125 | °C |
| Storage temperature range | T_{STG} | -55~+150 | °C |

ELECTRICAL CHARACTERISTICS (Ta=25°C unless otherwise specified)

| Parameter | Symbol | Test conditions | Min | Max | Unit |
|---------------------------------|------------|---|-----|-------------|------|
| Reverse breakdown voltage | $V_{(BR)}$ | $I_R = 10\mu A$ | 40 | | V |
| Reverse voltage leakage current | I_R | $V_R = 30V$ | | 200 | nA |
| Forward voltage | V_F | $I_F = 1mA$ $I_F = 40mA$ | | 380 1000 | mV |
| Diode capacitance | C_D | $V_R = 0, f = 1MHz$ | | 5 | pF |
| Reverse recovery time | t_{rr} | $I_{rr} = 1mA, I_R = I_F = 10mA$ $R_L = 100\Omega$ | | 5 | ns |

Typical Characteristics

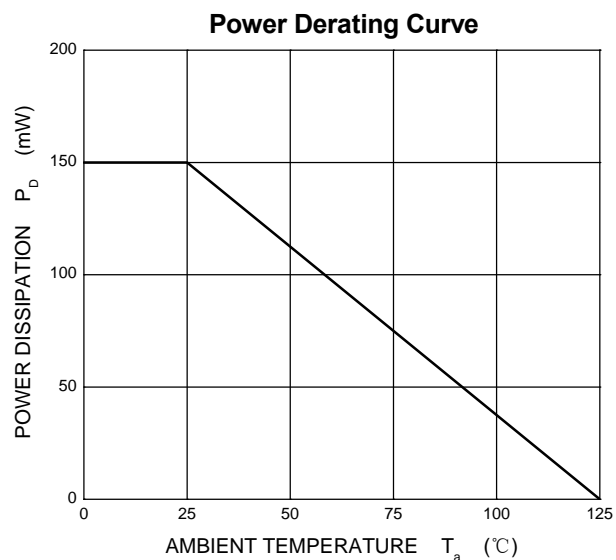
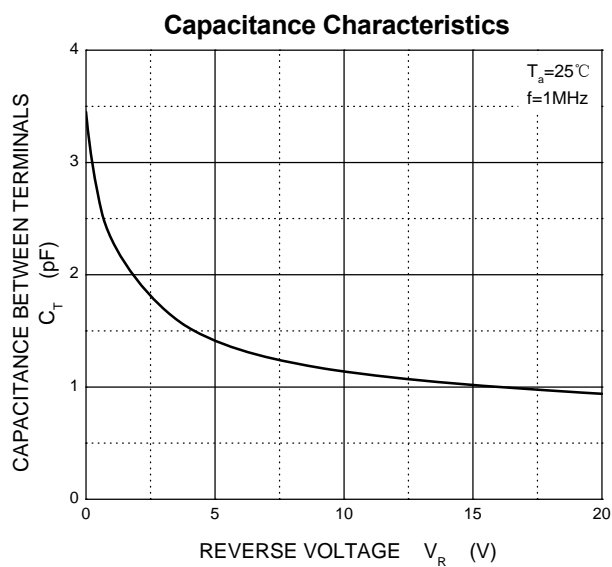
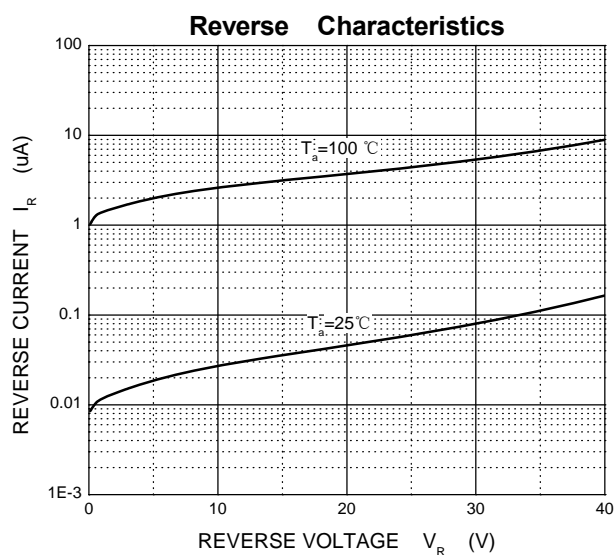
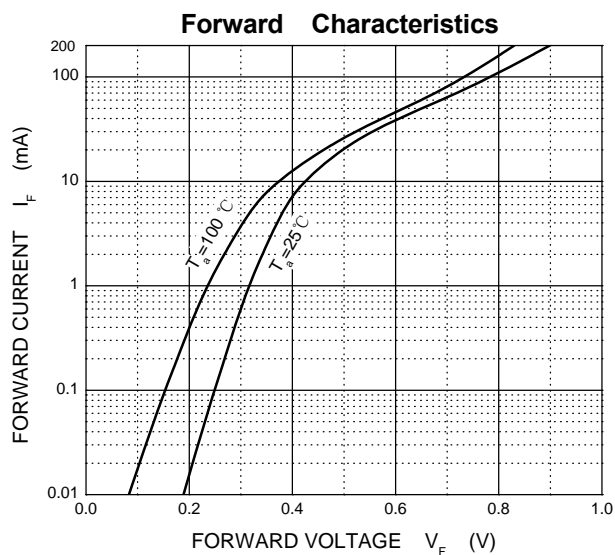

SOT-323 Package Outline Dimensions

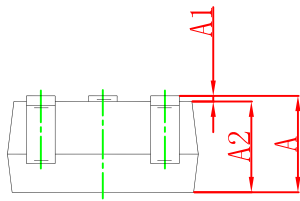
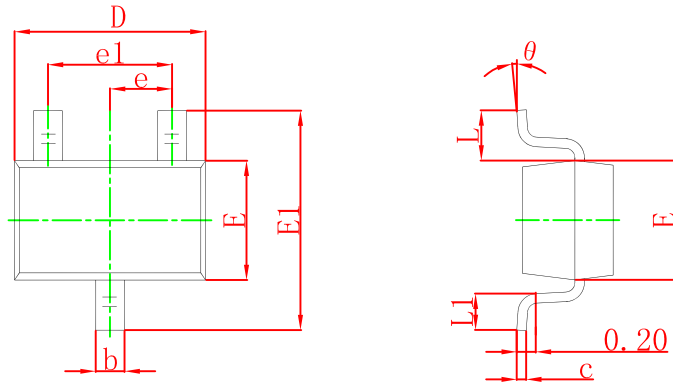

| Symbol | Dimensions In Millimeters | | Dimensions In Inches | |
|----------|---------------------------|-------|----------------------|-------|
| | Min | Max | Min | Max |
| A | 0.900 | 1.100 | 0.035 | 0.043 |
| A1 | 0.000 | 0.100 | 0.000 | 0.004 |
| A2 | 0.900 | 1.000 | 0.035 | 0.039 |
| b | 0.200 | 0.400 | 0.008 | 0.016 |
| c | 0.080 | 0.150 | 0.003 | 0.006 |
| D | 2.000 | 2.200 | 0.079 | 0.087 |
| E | 1.150 | 1.350 | 0.045 | 0.053 |
| E1 | 2.150 | 2.450 | 0.085 | 0.096 |
| e | 0.650 TYP | | 0.026 TYP | |
| e1 | 1.200 | 1.400 | 0.047 | 0.055 |
| L | 0.525 REF | | 0.021 REF | |
| L1 | 0.260 | 0.460 | 0.010 | 0.018 |
| θ | 0° | 8° | 0° | 8° |

SOT-323 Suggested Pad Layout

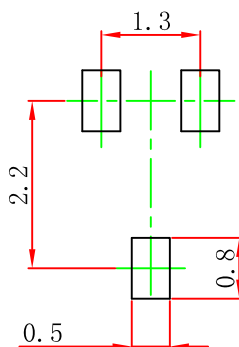

Note:

1. Controlling dimension: in millimeters.
2. General tolerance: ± 0.05 mm.
3. The pad layout is for reference purposes only.

NOTICE

JCET reserve the right to make modifications, enhancements, improvements, corrections or other changes without further notice to any product herein. JCET does not assume any liability arising out of the application or use of any product described herein.

SOT-323 Tape and Reel

SOT-323 Embossed Carrier Tape

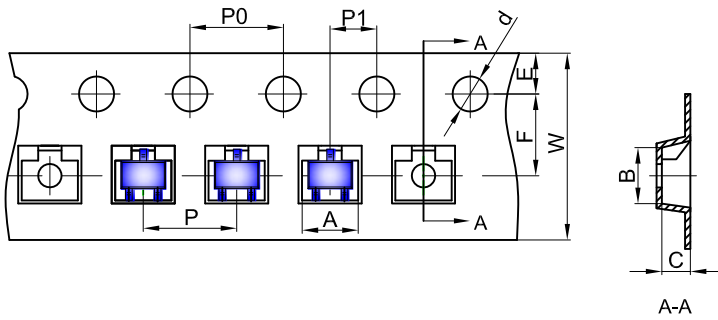

Packaging Description:
 SOT-323 parts are shipped in tape. The carrier tape is made from a dissipative (carbon filled) polycarbonate resin. The cover tape is a multilayer film (Heat Activated Adhesive in nature) primarily composed of polyester film, adhesive layer, sealant, and anti-static sprayed agent. These reeled parts in standard option are shipped with 3,000 units per 7" or 17.8cm diameter reel. The reels are clear in color and is made of polystyrene plastic (anti-static coated).

| Dimensions are in millimeter | | | | | | | | | | |
|------------------------------|------|------|------|-------|------|------|------|------|------|------|
| Pkg type | A | B | C | d | E | F | P0 | P | P1 | W |
| SOT-323 | 2.25 | 2.55 | 1.19 | Ø1.55 | 1.75 | 3.50 | 4.00 | 4.00 | 2.00 | 8.00 |

SOT-323 Tape Leader and Trailer

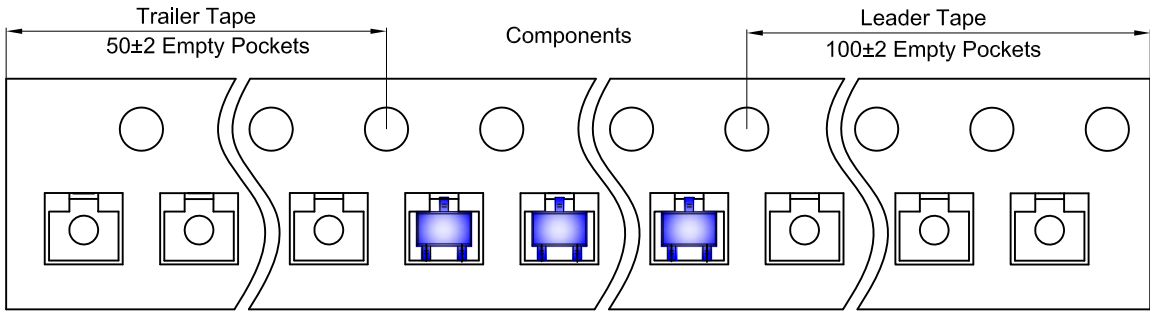

SOT-323 Reel

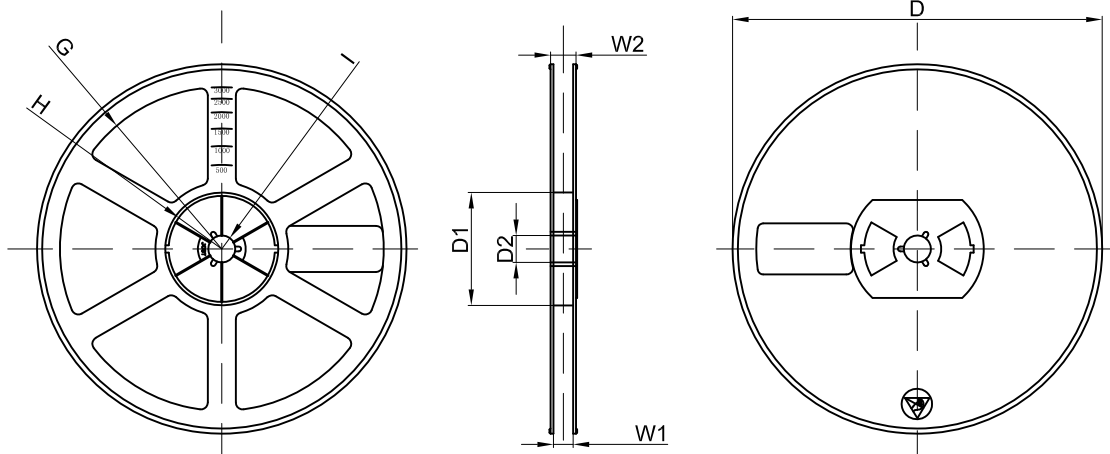

| Dimensions are in millimeter | | | | | | | | |
|------------------------------|---------|-------|-------|--------|--------|-------|------|-------|
| Reel Option | D | D1 | D2 | G | H | I | W1 | W2 |
| 7" Dia | Ø178.00 | 54.40 | 13.00 | R78.00 | R25.60 | R6.50 | 9.50 | 12.30 |

| REEL | Reel Size | Box | Box Size(mm) | Carton | Carton Size(mm) | G.W.(kg) |
|----------|-----------|------------|--------------|-------------|-----------------|----------|
| 3000 pcs | 7 inch | 45,000 pcs | 203×203×195 | 180,000 pcs | 438×438×220 | |