

BAS70WS

SMALL SIGNAL SCHOTTKY DIODE

Features

- Low forward voltage drop

PINNING

PIN	DESCRIPTION
1	Cathode
2	Anode

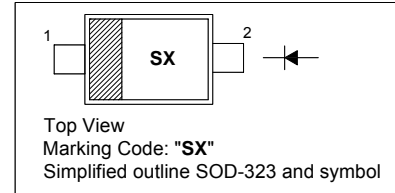

Absolute Maximum Ratings ($T_a = 25\text{ }^\circ\text{C}$)

Parameter	Symbol	Value	Unit
Repetitive Peak Reverse Voltage	V_{RRM}	70	V
Continuous Forward Current	I_F	70	mA
Surge Non-Repetitive Forward Current ($t_p = 10\text{ ms}$)	I_{FSM}	1	A
Total Power Dissipation	P_{tot}	230	mW
Thermal Resistance Junction to Ambient ¹⁾	R_{thJA}	550	$^\circ\text{C/W}$
Junction Temperature	T_J	150	$^\circ\text{C}$
Storage Temperature Range	T_s	- 65 to + 150	$^\circ\text{C}$

¹⁾ Mounted on epoxy board, with recommended pad layout.

Characteristics at $T_a = 25\text{ }^\circ\text{C}$

Parameter	Symbol	Min.	Max.	Unit
Reverse Breakdown Voltage at $I_R = 10\text{ }\mu\text{A}$	V_{BR}	70	-	V
Forward Voltage at $I_F = 1\text{ mA}$	V_F	-	410	mV
Reverse Current at $V_R = 50\text{ V}$	I_R	-	100	nA
Diode Capacitance at $V_R = 0\text{ V}$, $f = 1\text{ MHz}$	C_{tot}	-	2	pF

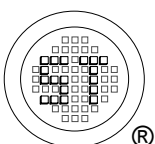

SEMTECH ELECTRONICS LTD.

(Subsidiary of Sino-Tech International Holdings Limited, a company
listed on the Hong Kong Stock Exchange, Stock Code: 724)



ISO/TS 16949 : 2002 Certificate No. 05103
ISO 14001:2004 Certificate No. 7116
ISO 9001:2000 Certificate No. 0506098

Dated : 01/09/2006

BAS70WS

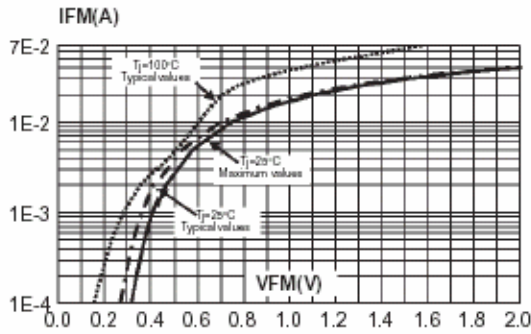

Reverse leakage current versus junction temperature (typical values).

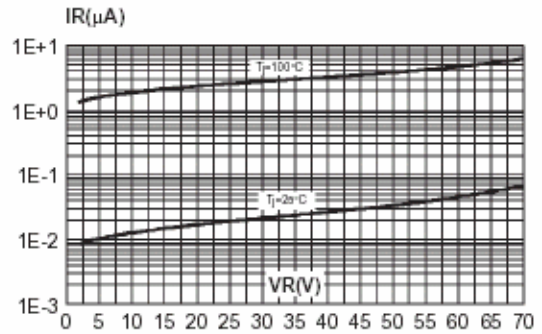

Junction capacitance versus reverse voltage applied (typical values).

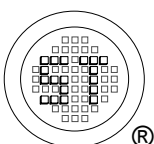
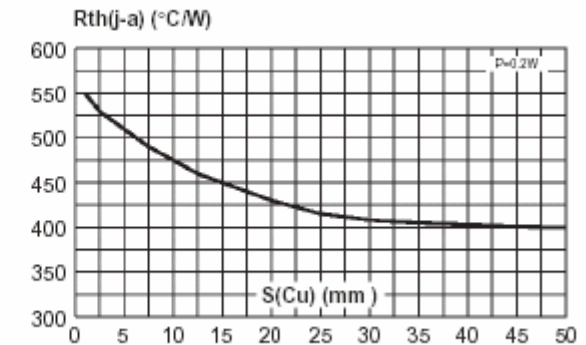
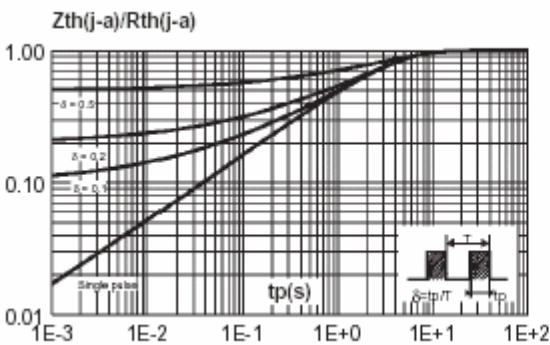
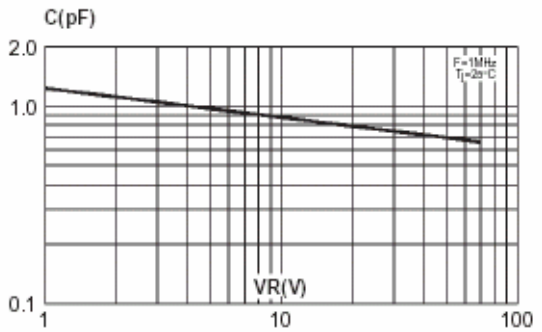
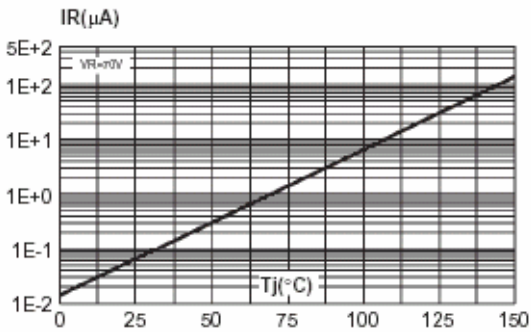

SEMTECH ELECTRONICS LTD.
 (Subsidiary of Sino-Tech International Holdings Limited, a company listed on the Hong Kong Stock Exchange, Stock Code: 724)



BAS70WS

PACKAGE OUTLINE

Plastic surface mounted package; 2 leads

SOD-323

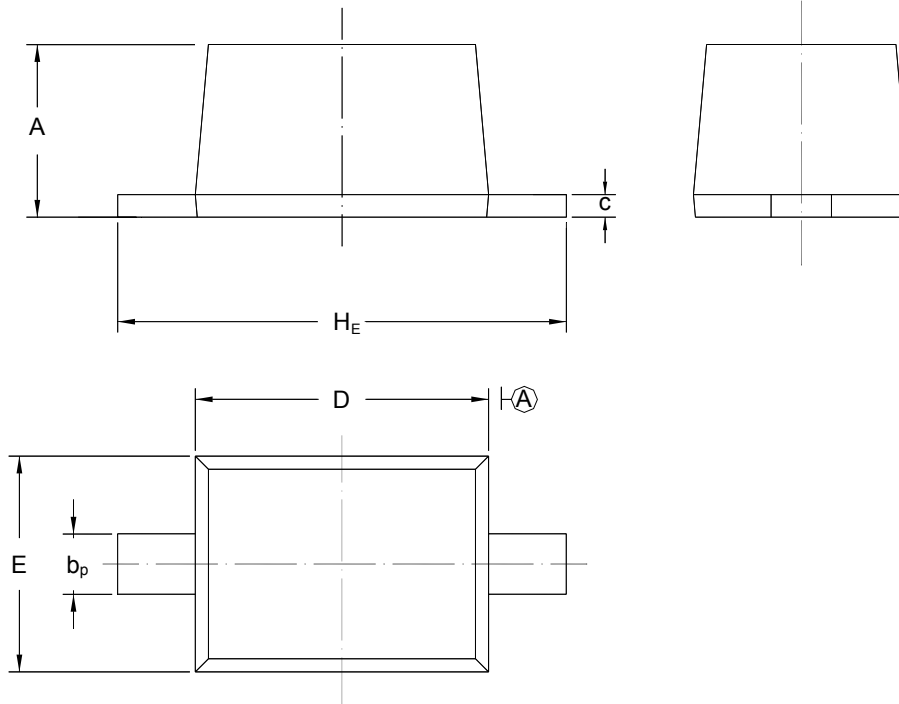

UNIT	A	b _p	C	D	E	H _E
mm	1.10 0.80	0.40 0.25	0.15 0.00	1.80 1.60	1.35 1.15	2.80 2.30

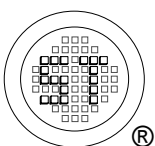

SEMTECH ELECTRONICS LTD.
 (Subsidiary of Sino-Tech International Holdings Limited, a company
 listed on the Hong Kong Stock Exchange, Stock Code: 724)



ISO/TS 16949 : 2002 Certificate No. 05103
 ISO 14001:2004 Certificate No. 7116
 ISO 9001:2000 Certificate No. 0506098

Dated : 01/09/2006