



BAS70x

DIODE

SCHOTTKY BARRIER DIODES

DESCRIPTION

Planar Schottky barrier diodes encapsulated in the SOT-23 small plastic SMD package. Single diodes and dual diodes with different pin configuration are available.

FEATURES

- *Low Turn-on voltage
- *Fast switching
- *Ultra-small surface mount package
- *Also available in lead free version

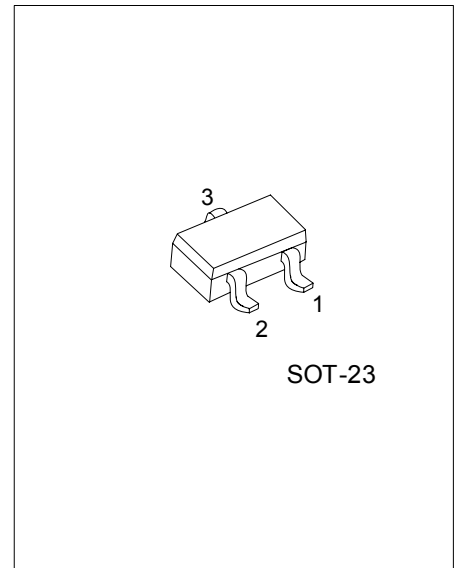

*Pb-free plating product number: BAS70xL

ORDERING INFORMATION

Order Number		Package	Pin Assignment			Packing
Normal	Lead Free Plating		1	2	3	
BAS70-AE3-R	BAS70L-AE3-R	SOT-23	x	A	K	Tape Reel
BAS70A-AE3-R	BAS70AL-AE3-R	SOT-23	K1	K2	A2A1	Tape Reel
BAS70C-AE3-R	BAS70CL-AE3-R	SOT-23	A1	A2	K2K1	Tape Reel
BAS70S-AE3-R	BAS70SL-AE3-R	SOT-23	K1	A2	K2A1	Tape Reel

Note: Pin Assignment: A: Anode K: Cathode x:NC

<p>BAS70L-AE3-R</p> <p>(1)Packing Type (2)Package Type (3)Lead Plating</p>	<p>(1) R: Tape Reel (2) AE3: SOT-23 (3) L: Lead Free Plating Blank: Pb/Sn</p>
--	---

■ DIODE CONFIGURATION AND SYMBOL

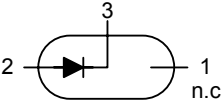
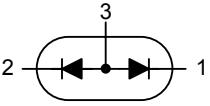
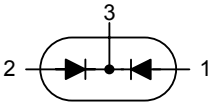
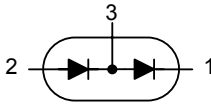
BAS70	BAS70A	BAS70C	BAS70S
			

■ MARKING

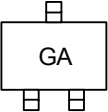
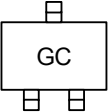
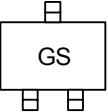
BAS70	BAS70A	BAS70C	BAS70S
			

■ ABSOLUTE MAXIMUM RATINGS ($T_A=25$, unless otherwise specified)

PARAMETER	SYMBOL	RATINGS	UNITS
DC Voltage	V_R	70	V
Forward Continuous Current	I_F	70	mA
Power Dissipation	P_D	200	mW
Junction Temperature	T_J	-55 ~ +150	
Storage Temperature	T_{STG}	-55 ~ +150	

Note Absolute maximum ratings are those values beyond which the device could be permanently damaged. Absolute maximum ratings are stress ratings only and functional device operation is not implied.

■ ELECTRICAL CHARACTERISTICS ($T_a=25$, unless otherwise specified)

PARAMETER	SYMBOL	TEST CONDITIONS	MIN	TYP	MAX	UNIT
Reverse Breakdown Voltage	BV_R	$I_R=10\mu A$	70			V
Reverse Voltage Leakage Current	I_R	$V_R=50V$			100	nA
Forward Voltage	V_F	$I_F=1mA$			410	mV
		$I_F=15mA$			1000	mV
Diode Capacitance	C_D	$V_R=0V, f=1MHz$			2	pF
Reverse Recovery Time	t_{RR}	$I_F=I_R=10mA, I_{RR}=0.1 \times I_R, R_L=100\Omega$			5	nS

■ TYPICAL CHARACTERISTICS

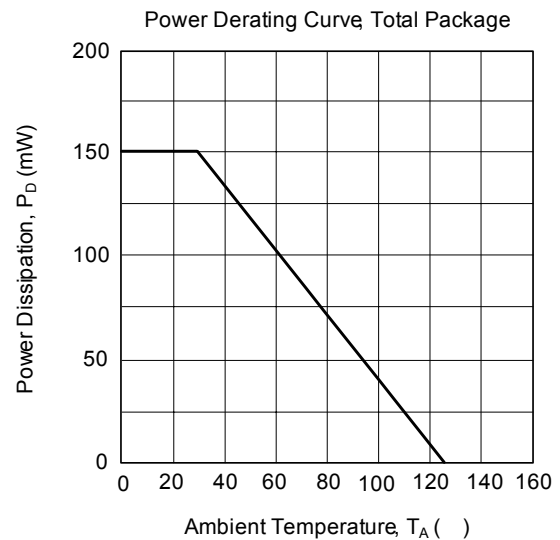
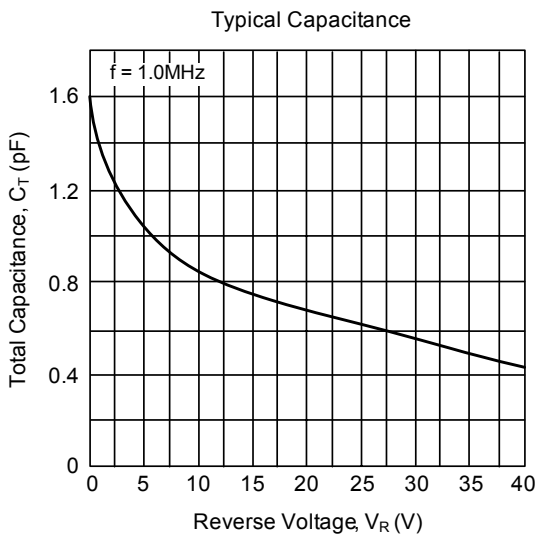
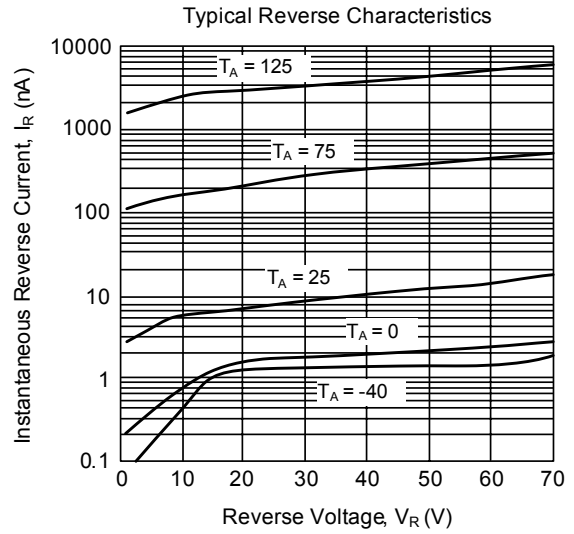
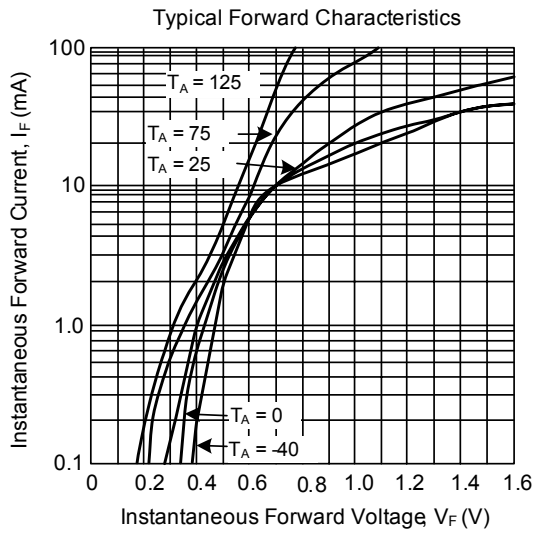

UTC assumes no responsibility for equipment failures that result from using products at values that exceed, even momentarily, rated values (such as maximum ratings, operating condition ranges, or other parameters) listed in products specifications of any and all UTC products described or contained herein. UTC products are not designed for use in life support appliances, devices or systems where malfunction of these products can be reasonably expected to result in personal injury. Reproduction in whole or in part is prohibited without the prior written consent of the copyright owner. The information presented in this document does not form part of any quotation or contract, is believed to be accurate and reliable and may be changed without notice.