

Silicon Schottky Diodes

- Low barrier type for DBS mixer applications up to 12 GHz, phase detectors and modulators
- Low noise figure
- Pb-free (RoHS compliant) package

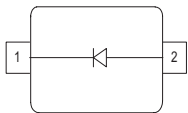

BAT15-02EL
BAT15-02ELS
BAT15-03W



BAT15-04W

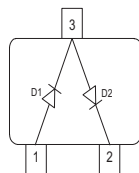

BAT15-05W

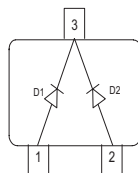

BAT15-099

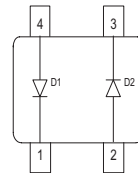

BAT15-099R

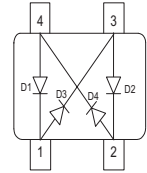

ESD (Electrostatic discharge) sensitive device, observe handling precaution!

Type	Package	Configuration	L_S (nH)	Marking
BAT15-02EL	TSLP-2-19	single, leadless	0.4	NN
BAT15-02ELS	TSSLP-2-3	single, leadless	0.2	S underline
BAT15-03W	SOD323	single	1.8	white P
BAT15-04W	SOT323	series	1.4	S8s
BAT15-05W	SOT323	common cathode	1.4	S5s
BAT15-099	SOT143	anti-parallel pair	2	S5s
BAT15-099R	SOT143	cross-over ring	2	S6s

Maximum Ratings at $T_A = 25\text{ °C}$, unless otherwise specified

Parameter	Symbol	Value	Unit
Diode reverse voltage	V_R	4	V
Forward current	I_F	110	mA
Total power dissipation BAT15-02ELS, $T_S \leq 73\text{ °C}$ BAT15-02EL, $T_S \leq 76\text{ °C}$ BAT15-03W, $T_S \leq 70\text{ °C}$ BAT15-04W, $T_S \leq 68\text{ °C}$ BAT15-05W, $T_S \leq 65\text{ °C}$ BAT15-099, $T_S \leq 48\text{ °C}$ BAT15-099R, $T_S \leq 67\text{ °C}$	P_{tot}	100 100 100 100 100 100 100	
Junction temperature	T_j	150	°C
Operating temperature range	T_{op}	-55 ... 150	
Storage temperature	T_{stg}	-55 ... 150	

Thermal Resistance

Parameter	Symbol	Value	Unit
Junction - soldering point ¹⁾ BAT15-02ELS BAT15-02EL BAT15-03W BAT15-04W BAT15-05W BAT15-099 BAT15-099R	R_{thJS}	≤ 770 ≤ 780 ≤ 795 ≤ 820 ≤ 850 ≤ 1020 ≤ 830	

¹⁾For calculation of R_{thJA} please refer to Application Note AN077 (Thermal Resistance Calculation)

Electrical Characteristics at $T_A = 25\text{ °C}$, unless otherwise specified

Parameter	Symbol	Values			Unit
		min.	typ.	max.	
DC Characteristics					
Breakdown voltage $I_{(BR)} = 100\text{ }\mu\text{A}$	$V_{(BR)}$	4	-	-	V
Reverse current $V_R = 1\text{ V}$	I_R	-	-	5	μA
Forward voltage $I_F = 1\text{ mA}$ $I_F = 10\text{ mA}$	V_F	0.16 0.25	0.23 0.32	0.32 0.41	V
Forward voltage matching ¹⁾ $I_F = 10\text{ mA}$	ΔV_F	-	-	20	mV

AC Characteristics

Diode capacitance $V_R = 0\text{ V}$, $f = 1\text{ MHz}$, BAT15-02ELS $V_R = 0\text{ V}$, $f = 1\text{ MHz}$, BAT15-099R $V_R = 0\text{ V}$, $f = 1\text{ MHz}$, all others types	C_T	- - -	- - -	0.23 0.5 0.35	pF
Differential forward resistance $I_F = 10\text{ mA} / 50\text{ mA}$	R_F	-	5.5	-	Ω

¹⁾ ΔV_F is the difference between lowest and highest V_F in a multiple diode component.

Diode capacitance $C_T = f(V_R)$

$f = 1\text{MHz}$

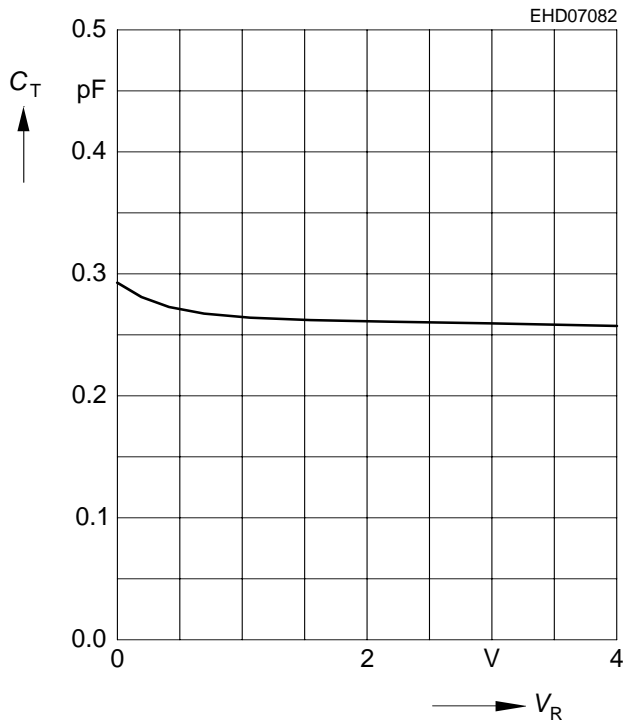

Reverse current $I_R = f(V_R)$

$T_A = \text{Parameter}$

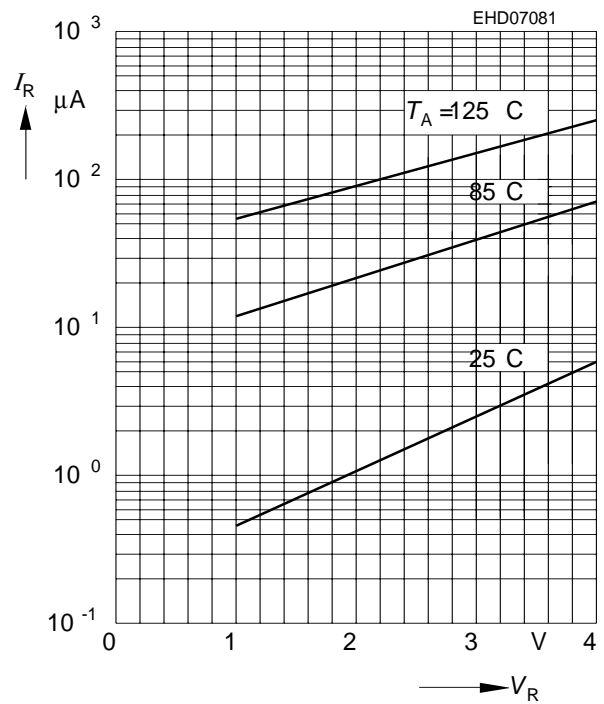

Forward current $I_F = f(V_F)$

$T_A = \text{Parameter}$

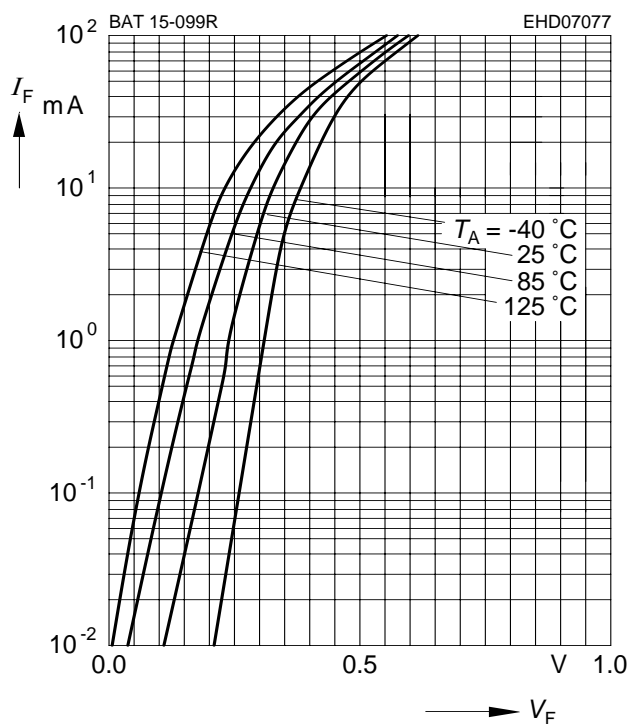

Forward current $I_F = f(T_S)$

BAT15-02EL

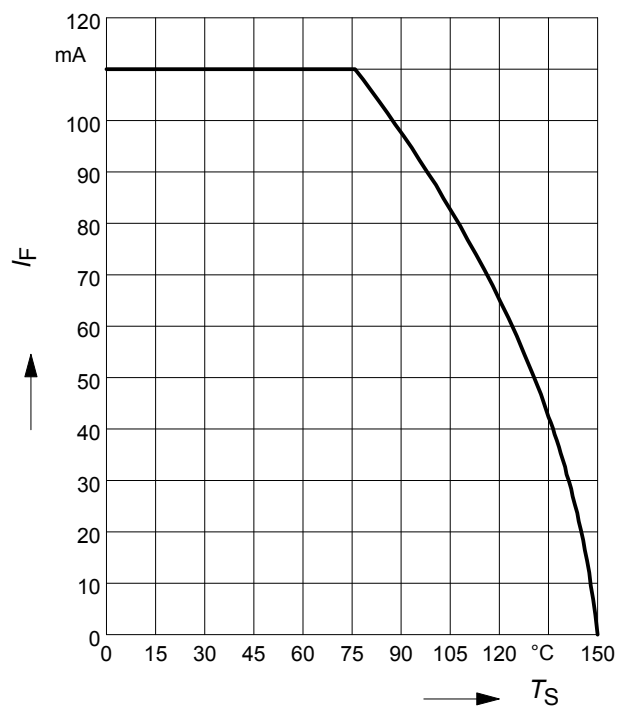

Forward current $I_F = f(T_S)$

BAT15-02ELS

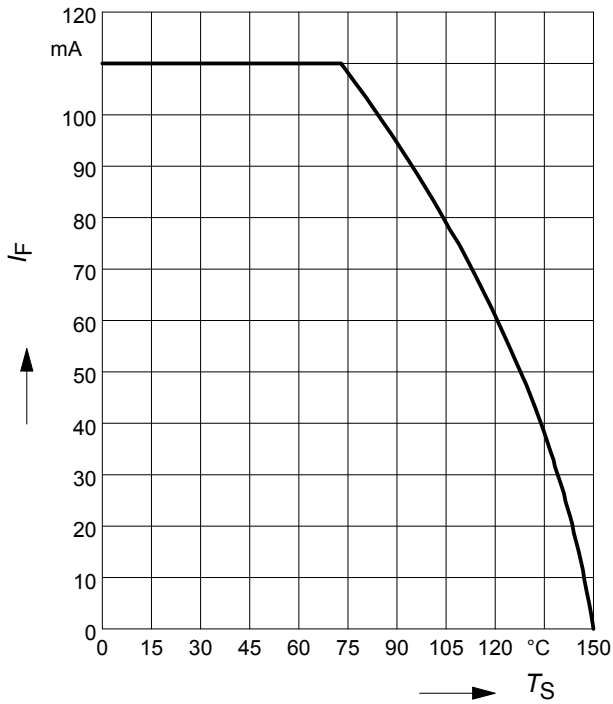

Forward current $I_F = f(T_S)$

BAT15-03W

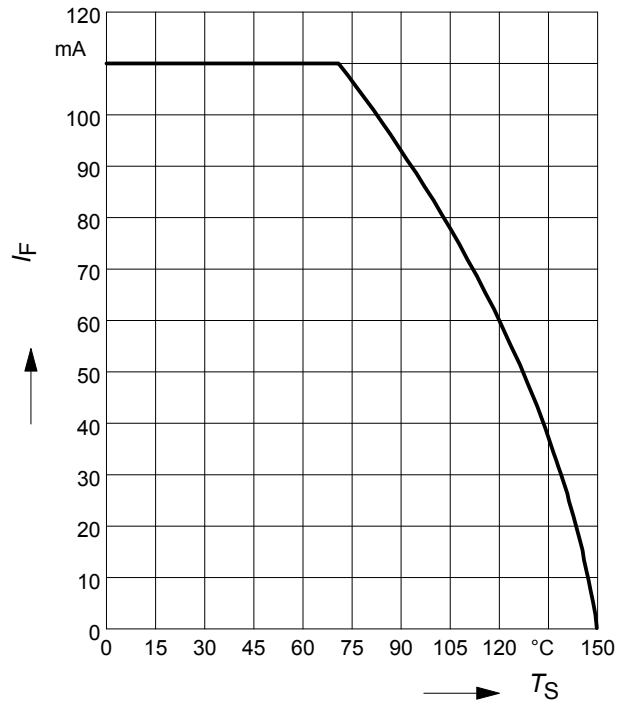

Forward current $I_F = f(T_S)$

BAT15-04W

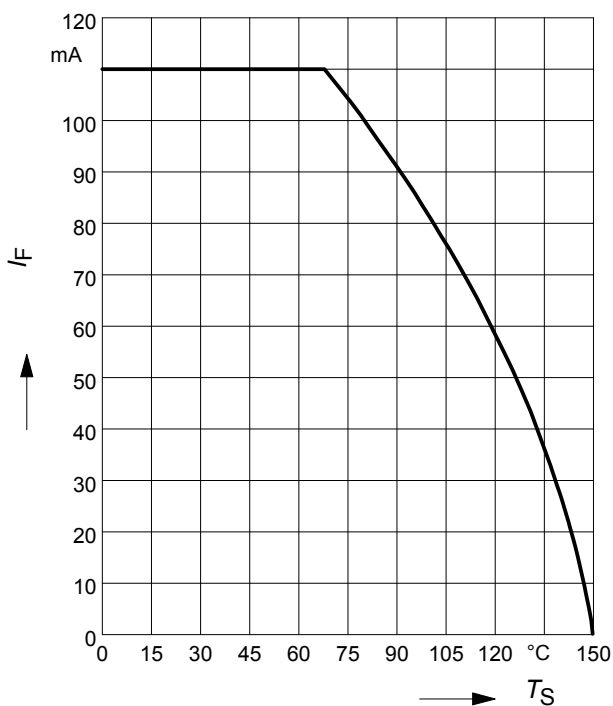

Forward current $I_F = f(T_S)$

BAT15-05W

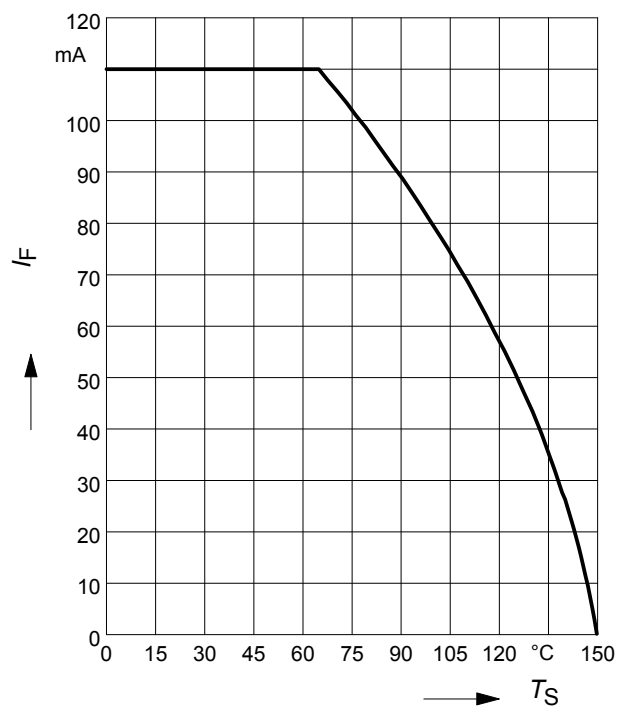

Forward current $I_F = f(T_S)$

BAT15-099

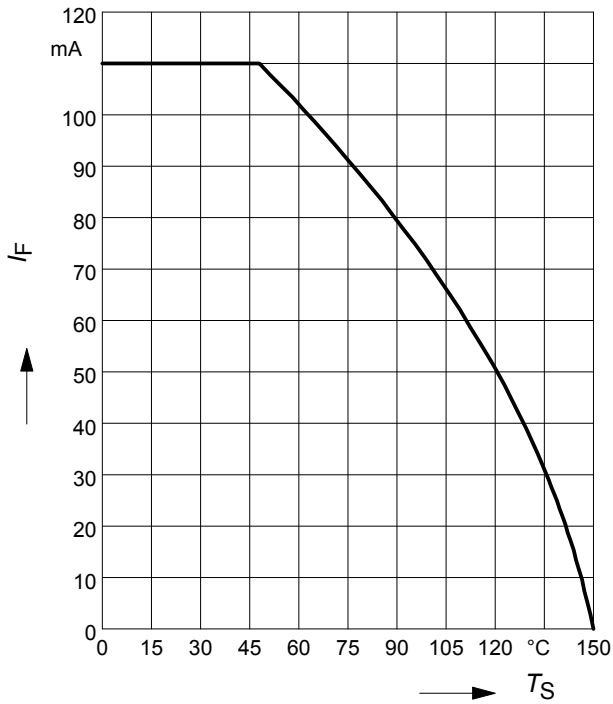

Forward current $I_F = f(T_S)$

BAT15-099R

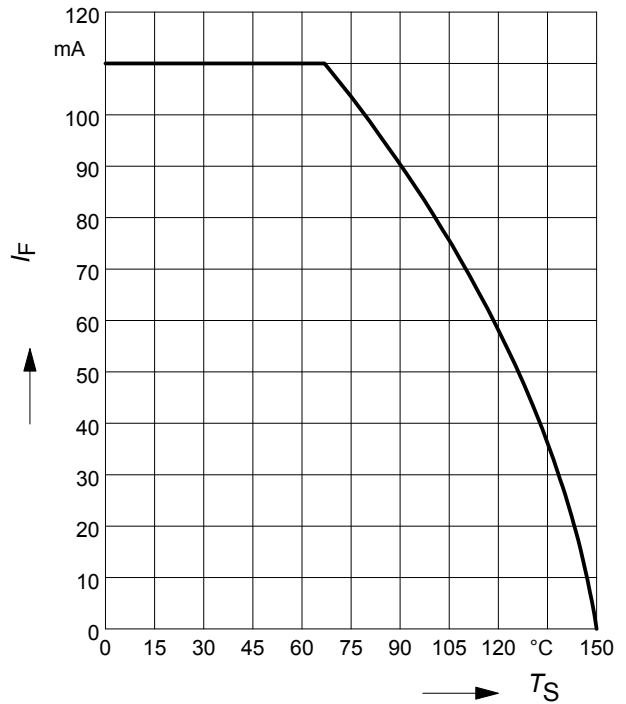

Permissible Puls Load $R_{thJS} = f(t_p)$

BAT15-02EL

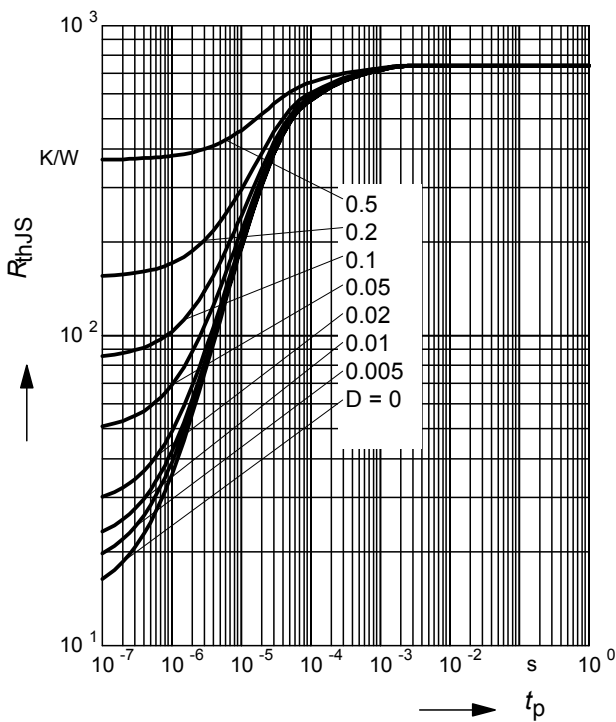

Permissible Pulse Load

$I_{Fmax} / I_{FDC} = f(t_p)$

BAT15-02EL

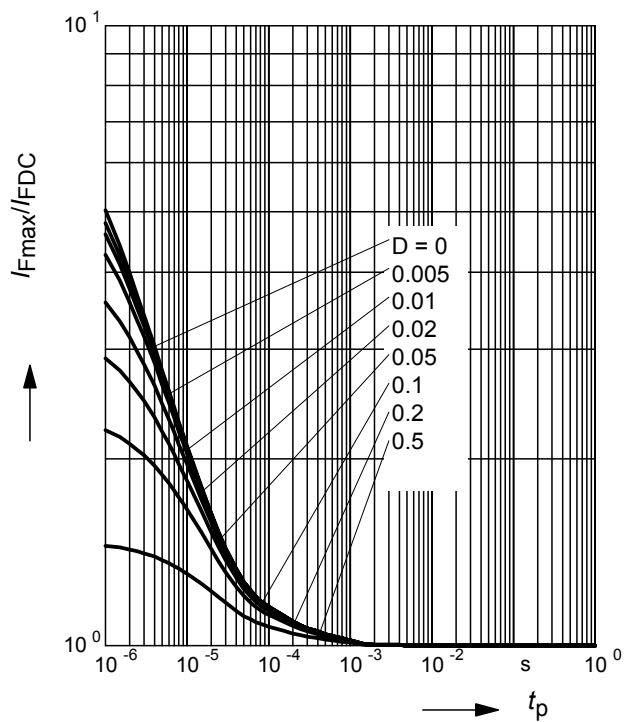

Permissible Puls Load $R_{thJS} = f(t_p)$

BAT15-03W

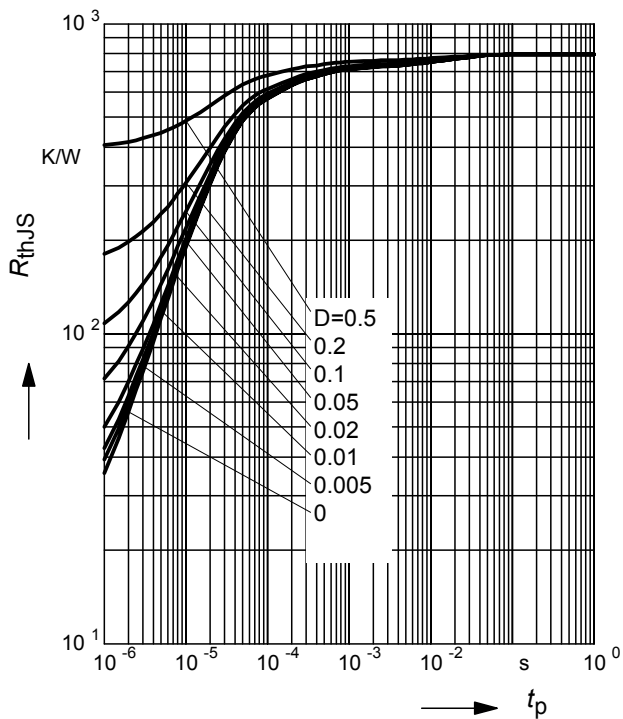

Permissible Pulse Load

$I_{Fmax} / I_{FDC} = f(t_p)$

BAT15-03W

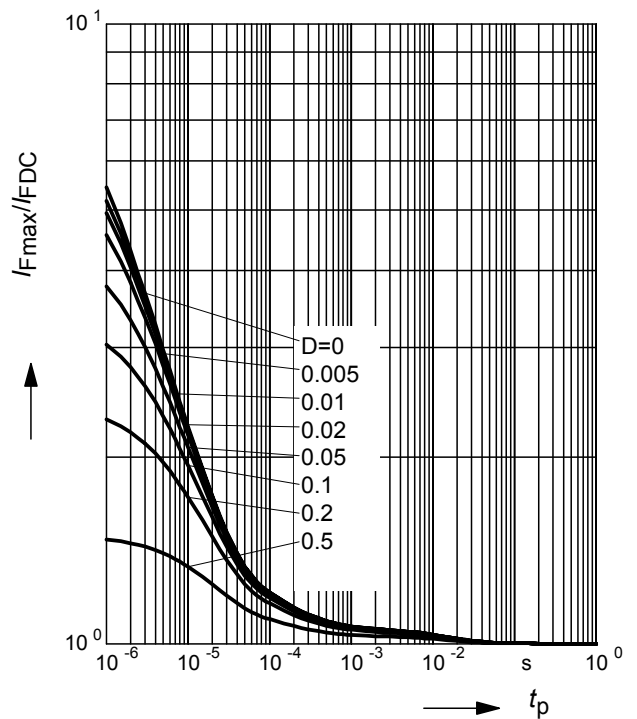

Permissible Puls Load $R_{thJS} = f(t_p)$

BAT15-04W

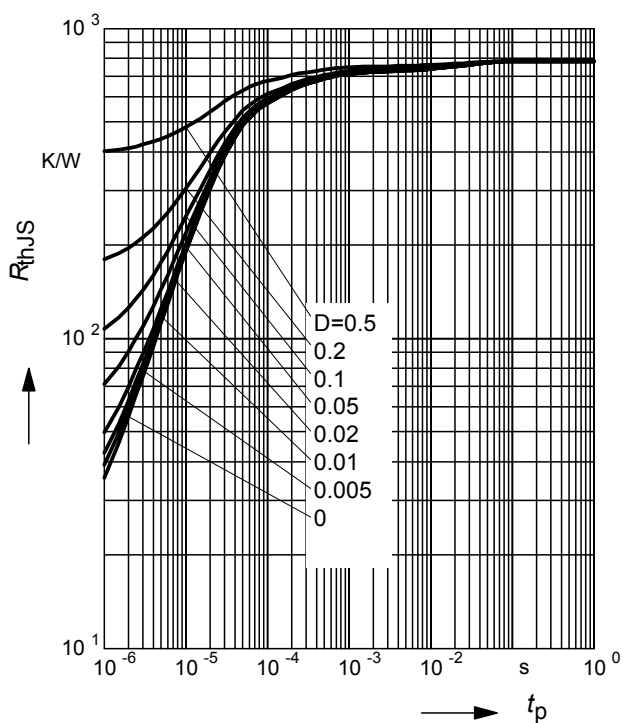

Permissible Pulse Load

$I_{Fmax} / I_{FDC} = f(t_p)$

BAT15-04W

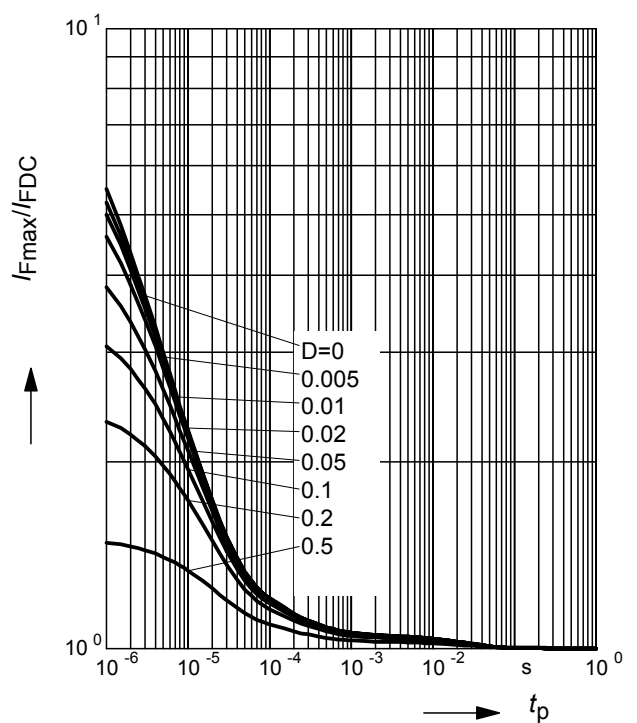

Permissible Puls Load $R_{thJS} = f(t_p)$

BAT15-05W

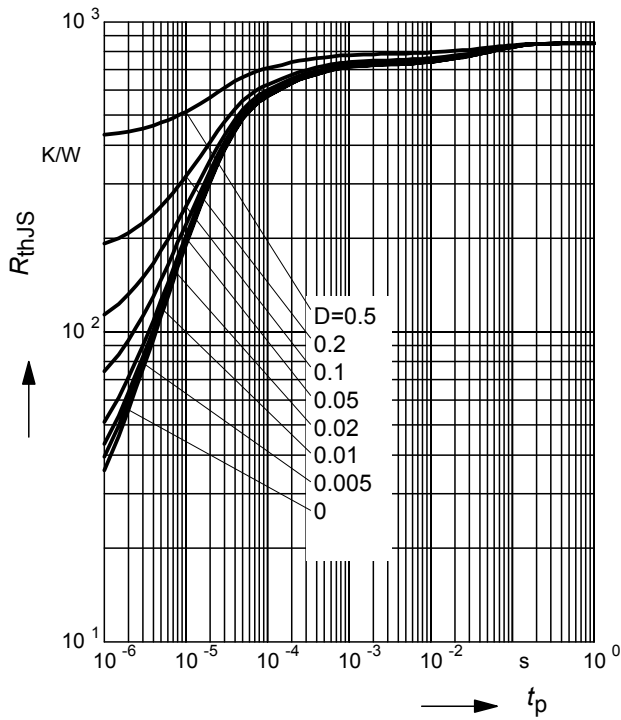

Permissible Pulse Load

$I_{Fmax} / I_{FDC} = f(t_p)$

BAT15-05W

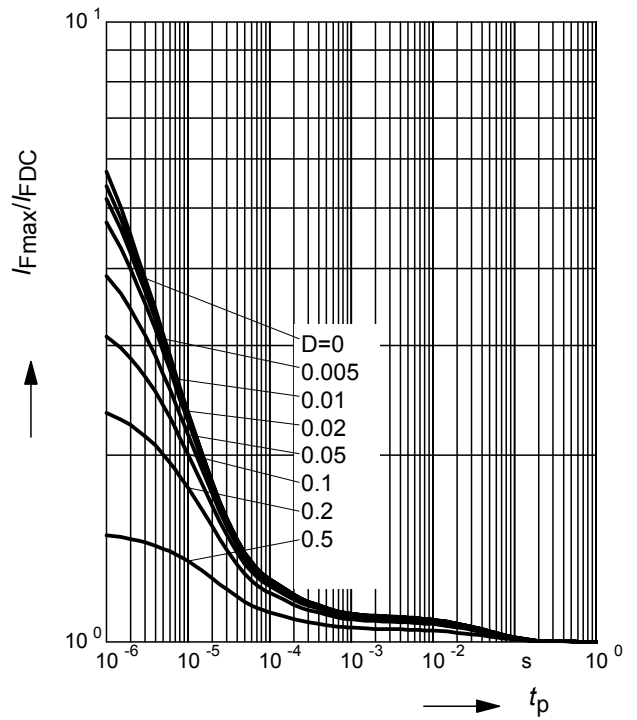

Permissible Puls Load $R_{thJS} = f(t_p)$

BAT15-099

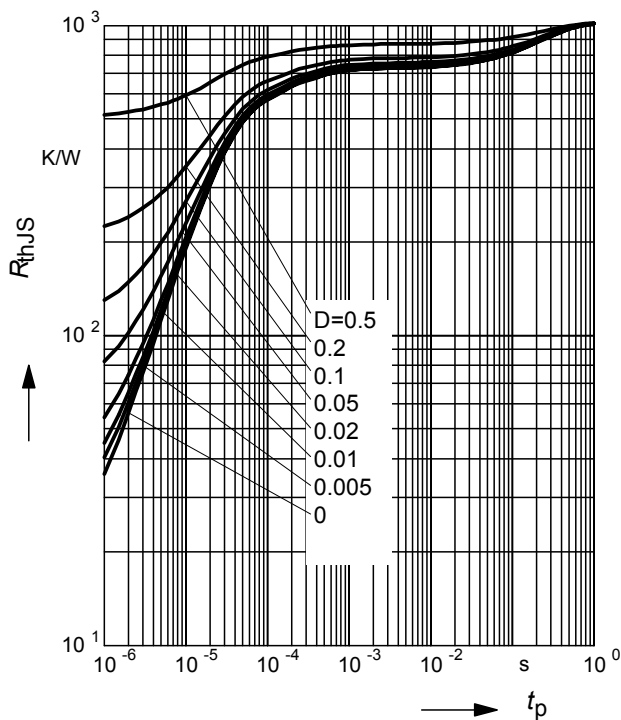

Permissible Pulse Load

$I_{Fmax} / I_{FDC} = f(t_p)$

BAT15-099

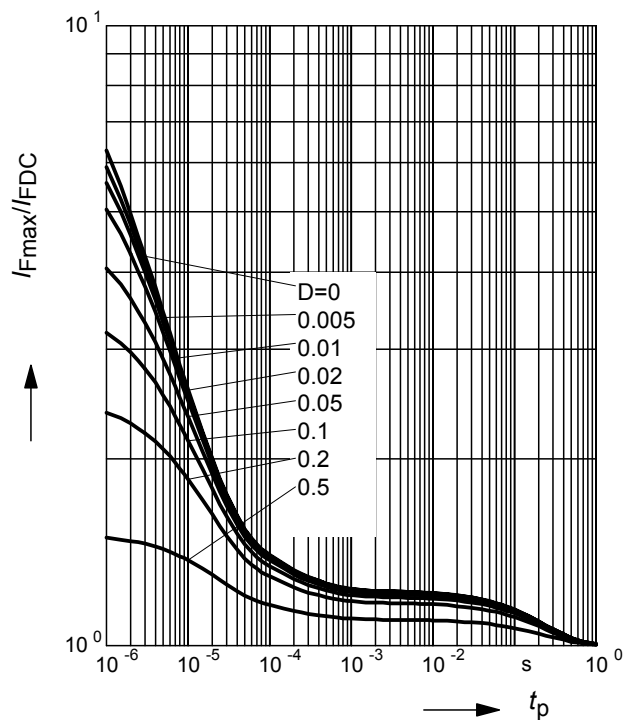

Permissible Puls Load $R_{thJS} = f(t_p)$

BAT15-099R

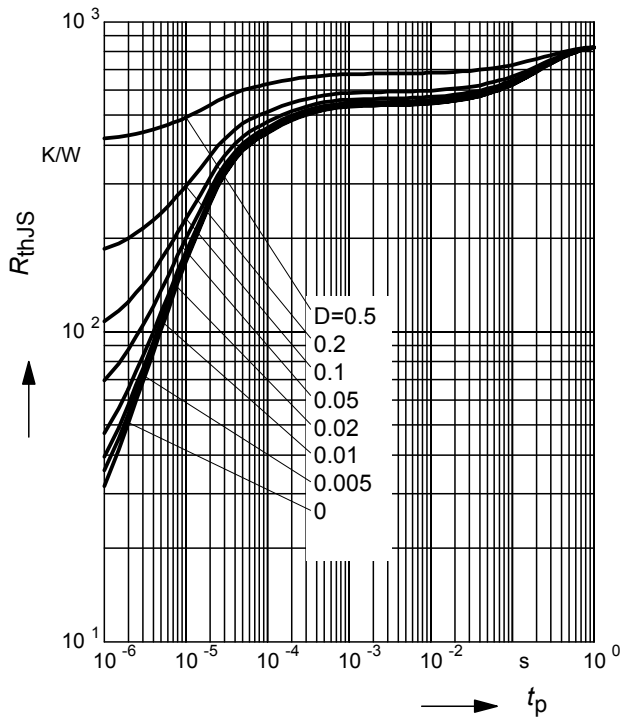

Permissible Pulse Load

$I_{Fmax} / I_{FDC} = f(t_p)$

BAT15-099R

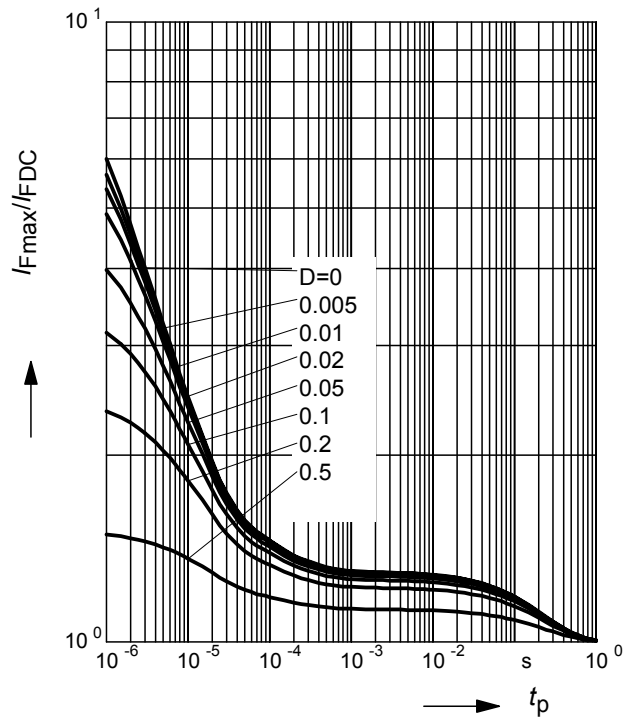

S₁₁-Parameters for BAT15-099

 Typical impedance characteristics (with external bias I and $Z_0 = 50\Omega$)

f	$I = 0.02 \text{ mA}$		$I = 0.05 \text{ mA}$		$I = 0.1 \text{ mA}$		$I = 0.2 \text{ mA}$		$I = 0.5 \text{ mA}$	
GHz	MAG	ANG	MAG	ANG	MAG	ANG	MAG	ANG	MAG	ANG
1	0.94	-16.4	0.84	-16.6	0.77	-16.4	0.59	-17.2	0.19	-16.7
2	0.93	-33.8	0.88	-33.8	0.77	-34.5	0.58	-35.2	0.15	-36.1
3	0.92	-53.8	0.86	-54.5	0.75	-54.1	0.58	-56.1	0.13	-64.8
4	0.91	-74.3	0.84	-75.3	0.72	-76.4	0.51	-78.4	0.11	-104.8
5	0.91	-96.6	0.84	-97.6	0.72	-99.1	0.53	-102.3	0.15	-135.7
6	0.91	-115.4	0.84	-116.7	0.73	-118.7	0.53	-122.9	0.18	-160.9
7	0.91	-131	0.84	-132.3	0.73	-134.1	0.54	-138.1	0.2	-168.8
8	0.91	-143	0.84	-144.5	0.73	-146.8	0.55	-150.5	0.81	179.4
9	0.91	-155.6	0.83	-150.2	0.71	-159.7	0.53	-163.9	0.18	179.4
10	0.9	-167.3	0.83	-169.7	0.71	-178.8	0.51	-175.8	0.14	151.2
11	0.89	175.5	0.8	172.6	0.7	170	0.45	164.9	0.09	105.5
12	0.88	175.5	0.76	146.5	0.62	142.8	0.39	134.2	0.14	43.6

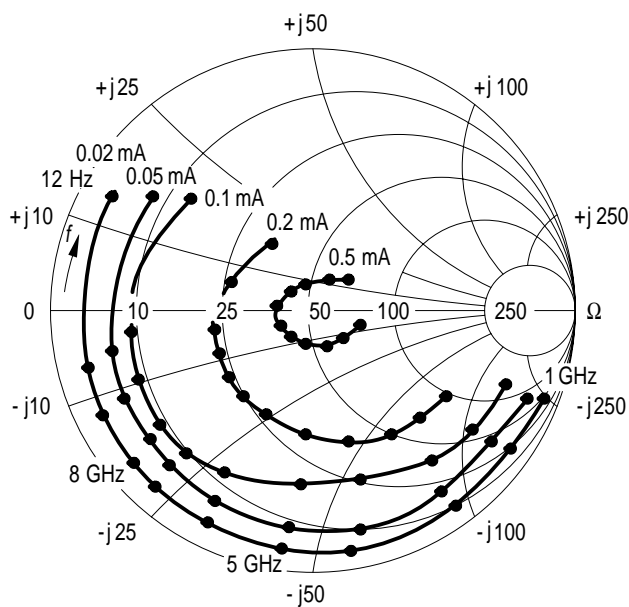
S₁₁ = (f, I) BAT15-099

EHD07083

Package Outline

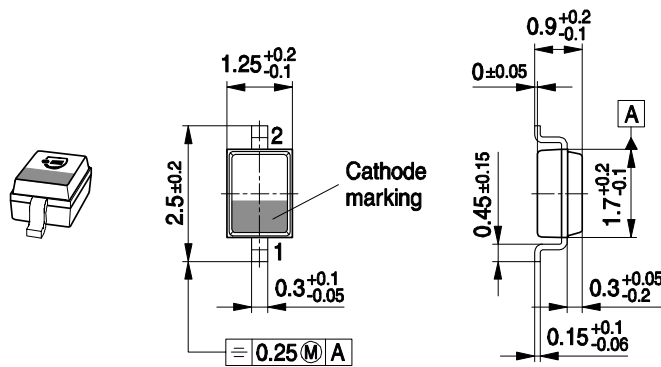

Foot Print

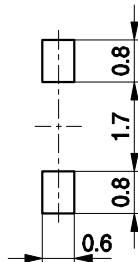

Marking Layout (Example)



Standard Packing

Reel ø180 mm = 3.000 Pieces/Reel
 Reel ø330 mm = 10.000 Pieces/Reel

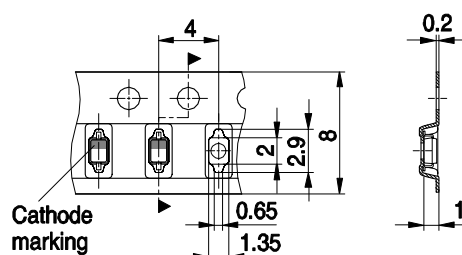

Package Outline

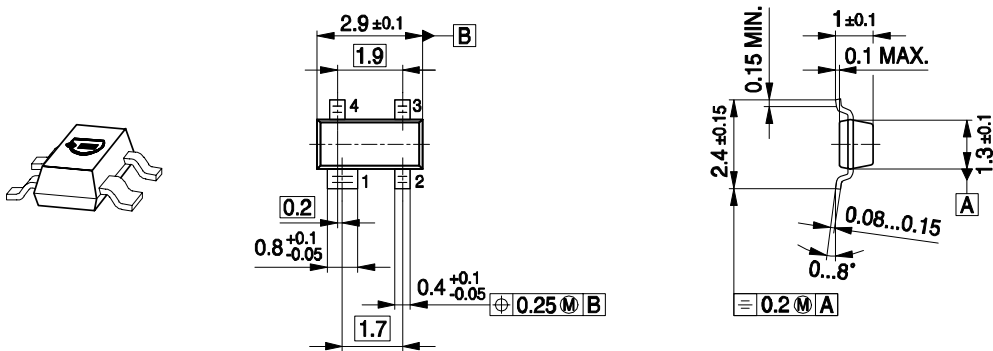

Note: Mold flash, protrusions or gate burrs of 0,2 mm max. per side are not included

SOT143-PO V09

Foot Print

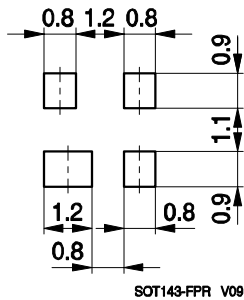

Marking Layout (Example)

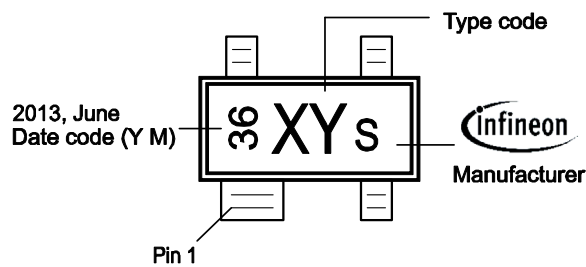

Standard Packing

Reel ø180 mm = 3.000 Pieces/Reel
 Reel ø330 mm = 10.000 Pieces/Reel

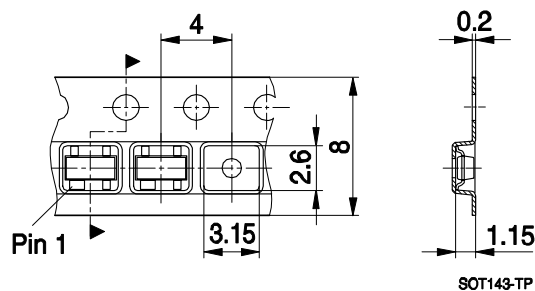

Package Outline



Foot Print



Marking Layout (Example)



Standard Packing

Reel $\varnothing 180$ mm = 3.000 Pieces/Reel
 Reel $\varnothing 330$ mm = 10.000 Pieces/Reel



Package Outline



TSLP-2-19, -20-PO V01

Foot Print

For board assembly information please refer to Infineon website „Packages“



TSLP-2-19, -20-FP V01

Marking layout (Example)

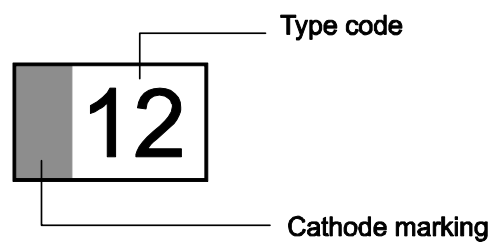

Standard Packing

Reel Ø 180 mm: 15.000 Pieces / Reel
Reels/Box: 1

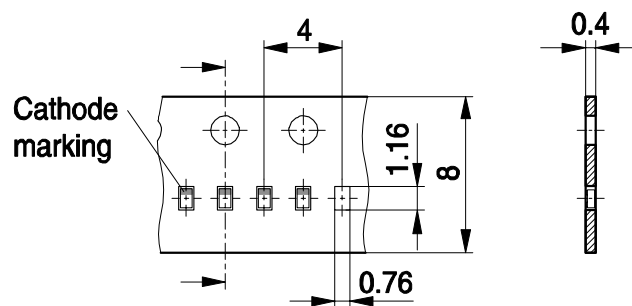

TSLP-2-19, -20-TP V02

Package Outline

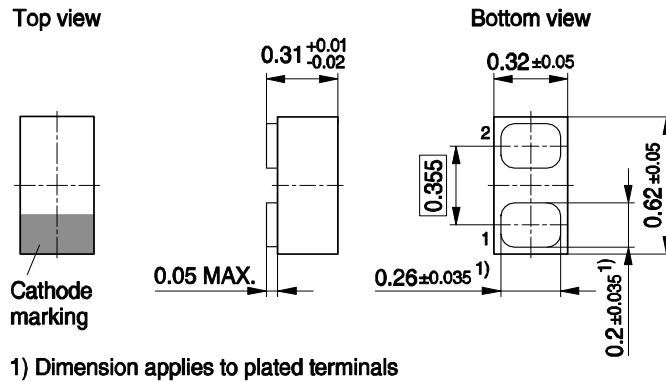

Foot Print

For board assembly information please refer to Infineon website "Packages"

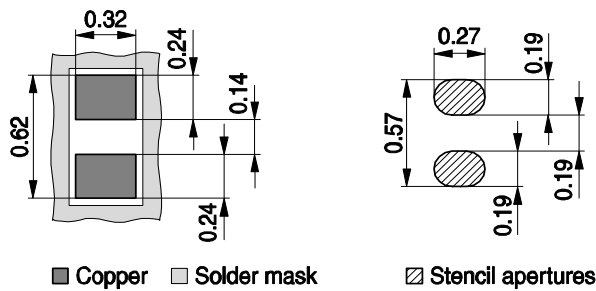

Marking Layout (Example)

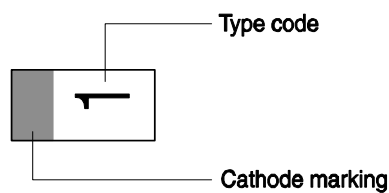

Standard Packing

Reel ø180 mm = 15.000 Pieces/Reel

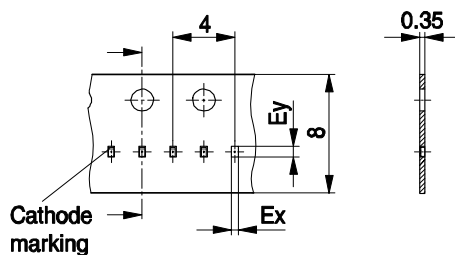

Tape type	Ex	Ey
Punched Tape	0.43	0.73
Embossed Tape	0.37	0.67

Deliveries can be both tape types (no selection possible). Specification allows identical processing (pick & place) by users.

Edition 2009-11-16

**Published by
Infineon Technologies AG
81726 Munich, Germany**

**© 2009 Infineon Technologies AG
All Rights Reserved.**

Legal Disclaimer

The information given in this document shall in no event be regarded as a guarantee of conditions or characteristics. With respect to any examples or hints given herein, any typical values stated herein and/or any information regarding the application of the device, Infineon Technologies hereby disclaims any and all warranties and liabilities of any kind, including without limitation, warranties of non-infringement of intellectual property rights of any third party.

Information

For further information on technology, delivery terms and conditions and prices, please contact the nearest Infineon Technologies Office (www.infineon.com).

Warnings

Due to technical requirements, components may contain dangerous substances. For information on the types in question, please contact the nearest Infineon Technologies Office.

Infineon Technologies components may be used in life-support devices or systems only with the express written approval of Infineon Technologies, if a failure of such components can reasonably be expected to cause the failure of that life-support device or system or to affect the safety or effectiveness of that device or system. Life support devices or systems are intended to be implanted in the human body or to support and/or maintain and sustain and/or protect human life. If they fail, it is reasonable to assume that the health of the user or other persons may be endangered.