

Silicon Schottky Diode

- For mixer applications in VHF/UHF range
- For high-speed switching application
- Pb-free (RoHS compliant) package

BAT17

**BAT17-04
BAT17-04W**

**BAT17-05
BAT17-05W**

BAT17-06W

BAT17-07

ESD (Electrostatic discharge) sensitive device, observe handling precaution!

Type	Package	Configuration	L_S (nH)	Marking
BAT17	SOT23	single	1.8	53s
BAT17-04	SOT23	series	1.8	54s
BAT17-04W	SOT323	series	1.4	54s
BAT17-05	SOT23	common cathode	1.8	55s
BAT17-05W	SOT323	common cathode	1.4	55s
BAT17-06W	SOT323	common anode	1.4	56s
BAT17-07	SOT143	parallel pair	2	57s

Maximum Ratings at $T_A = 25^\circ\text{C}$, unless otherwise specified

Parameter	Symbol	Value	Unit
Diode reverse voltage	V_R	4	V
Forward current	I_F	130	mA
Total power dissipation	P_{tot}		mW
BAT17, $T_S \leq 77^\circ\text{C}$		150	
BAT17-04, $T_S \leq 61^\circ\text{C}$		150	
BAT17-05, $T_S \leq 46^\circ\text{C}$		150	
BAT17-04W, -05W, -6W, $T_S \leq 92^\circ\text{C}$		150	
BAT17-07, $T_S \leq 60^\circ\text{C}$		150	
Junction temperature	T_j	150	$^\circ\text{C}$
Operating temperature range	T_{op}	-55 ... 125	
Storage temperature	T_{stg}	-55 ... 150	

Thermal Resistance

Parameter	Symbol	Value	Unit
Junction - soldering point ¹⁾	R_{thJS}		K/W
BAT17		≤ 490	
BAT17-04, BAT17-07		≤ 590	
BAT17-05		≤ 690	
BAT17-04W, BAT17-05W, BAT17-06W		≤ 390	

¹⁾For calculation of R_{thJA} please refer to Application Note Thermal Resistance

Electrical Characteristics at $T_A = 25^\circ\text{C}$, unless otherwise specified

Parameter	Symbol	Values			Unit
		min.	typ.	max.	
DC Characteristics					
Breakdown voltage $I_{(BR)} = 10 \mu\text{A}$	$V_{(BR)}$	4	-	-	V
Reverse current $V_R = 3 \text{ V}$ $V_R = 4 \text{ V}$ $V_R = 3 \text{ V}, T_A = 60^\circ\text{C}$	I_R	-	-	0.25 10 1.25	μA
Forward voltage $I_F = 0.1 \text{ mA}$ $I_F = 1 \text{ mA}$ $I_F = 10 \text{ mA}$	V_F	200 250 350	275 340 425	350 450 600	mV
Forward voltage matching ¹⁾ $I_F = 1 \text{ mA}$	ΔV_F	-	-	20	
AC Characteristics					
Diode capacitance $V_R = 0, f = 1 \text{ MHz}$	C_T	0.4	0.55	0.75	pF
Differential forward resistance $I_F = 5 \text{ mA}, f = 10 \text{ kHz}$	R_F	-	8	15	Ω

¹⁾ ΔV_F is the difference between lowest and highest V_F in multiple diode component.

Diode capacitance $C_T = f(V_R)$

$f = 1\text{MHz}$

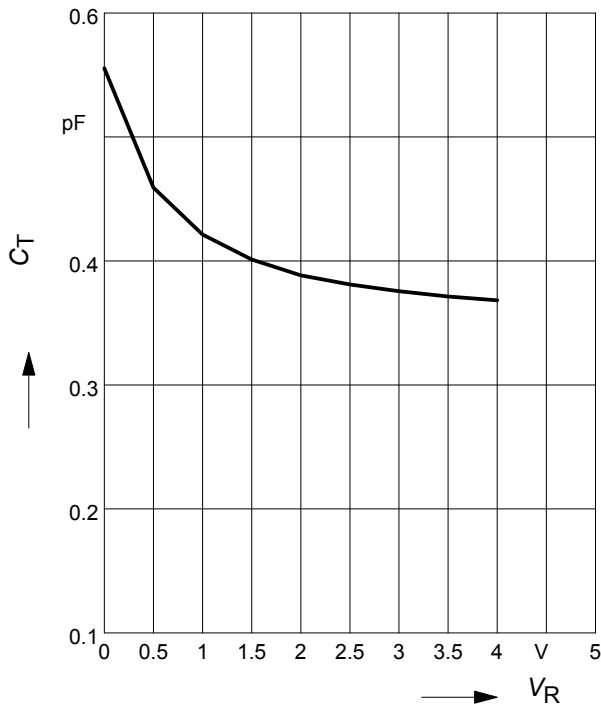

Forward resistance $r_f = f(I_F)$

$f = 10\text{kHz}$

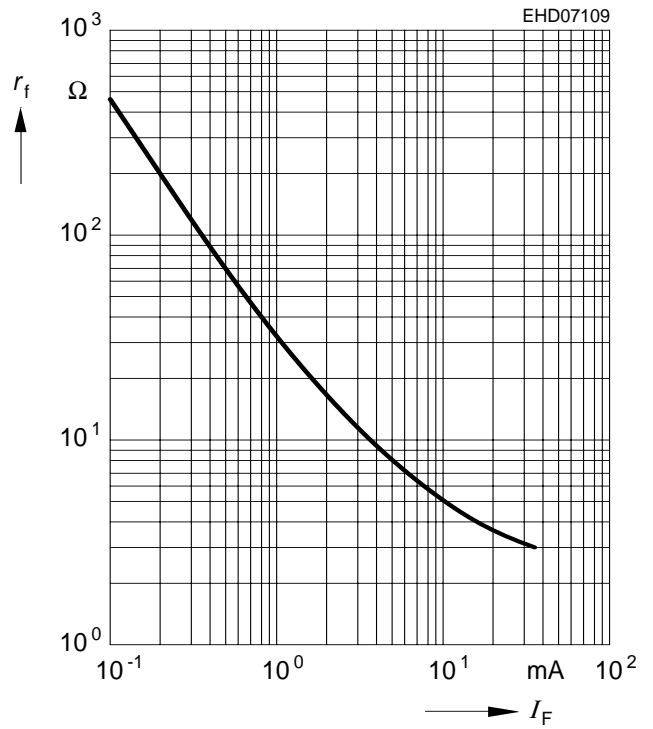

Reverse current $I_R = f(V_R)$

$T_A = \text{Parameter}$

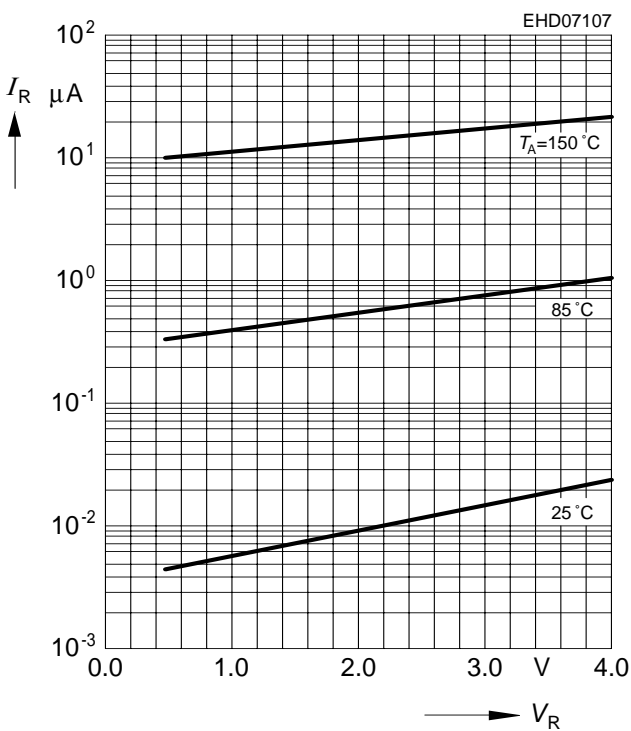

Forward current $I_F = f(V_F)$

$T_A = \text{Parameter}$

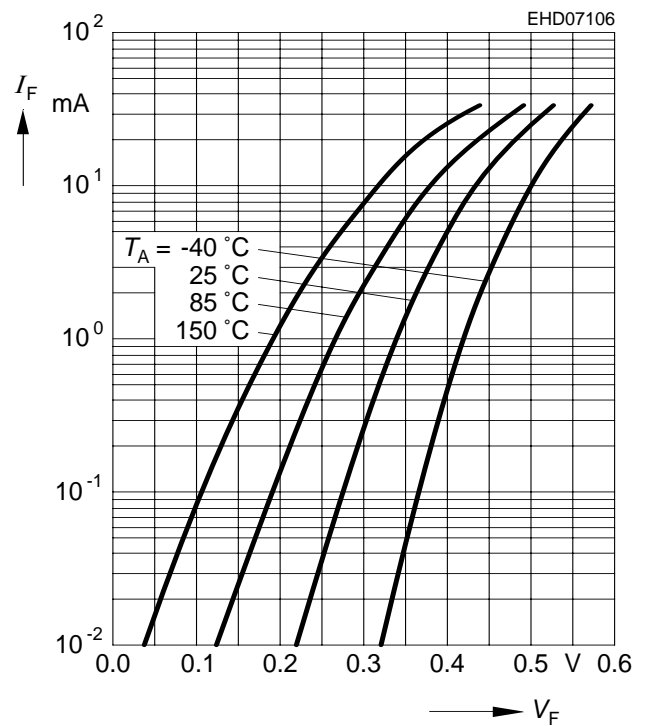

Forward current $I_F = f(T_S)$

BAT17

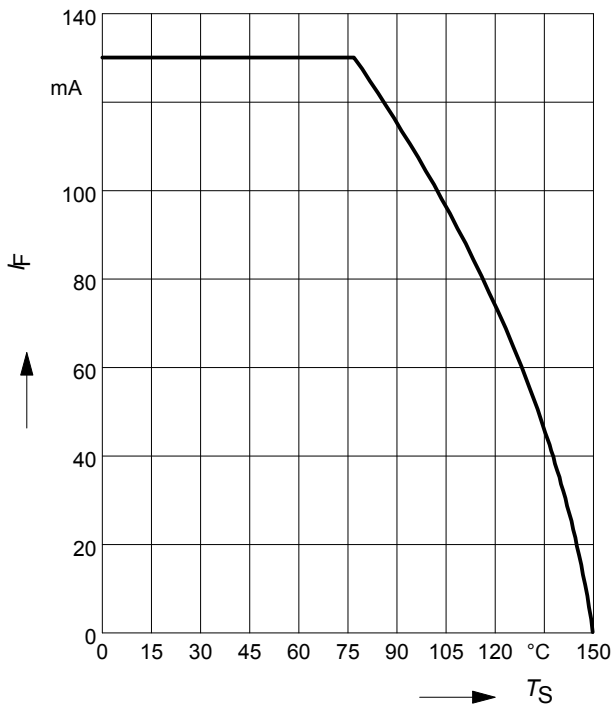

Forward current $I_F = f(T_S)$

BAT17-04, BAT17-07

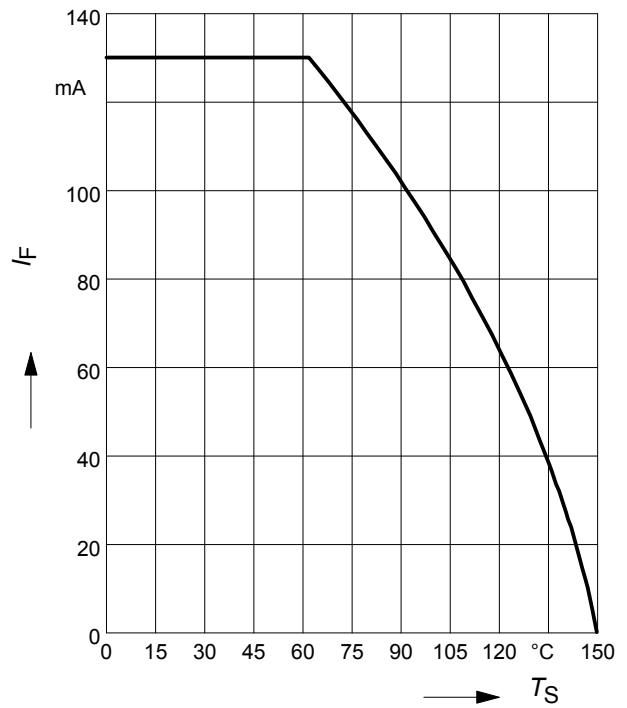

Forward current $I_F = f(T_S)$

BAT17-05

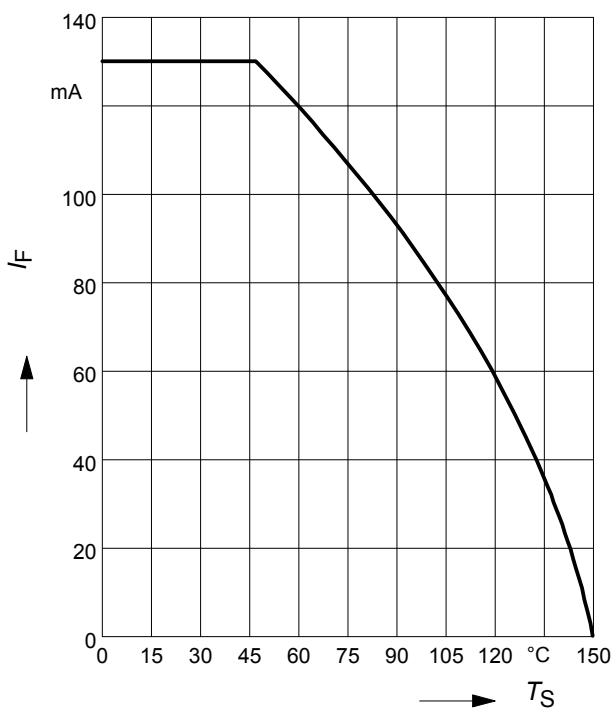

Package Outline

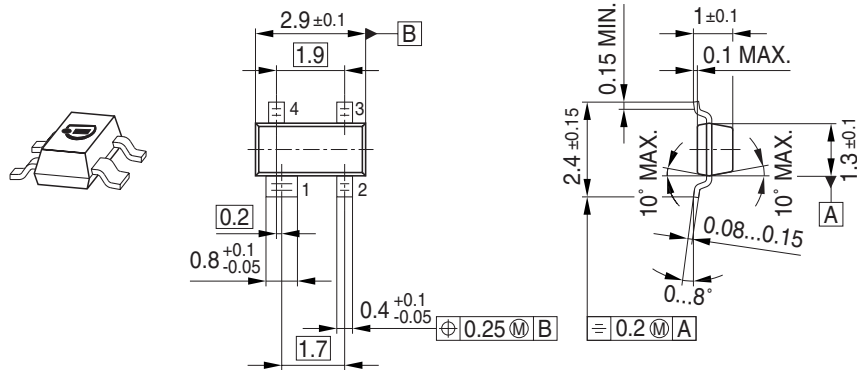

Foot Print

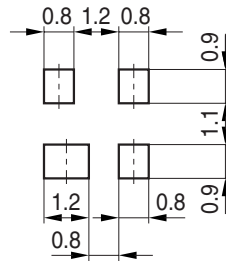

Marking Layout (Example)



Standard Packing

Reel $\phi 180 \text{ mm} = 3.000 \text{ Pieces/Reel}$
 Reel $\phi 330 \text{ mm} = 10.000 \text{ Pieces/Reel}$

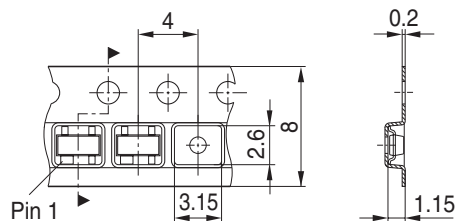

Package Outline



1) Lead width can be 0.6 max. in dambar area

Foot Print



Marking Layout (Example)

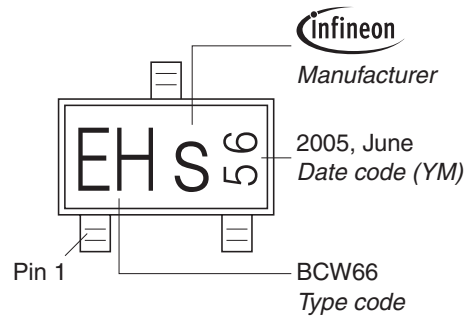

Standard Packing

Reel \varnothing 180 mm = 3.000 Pieces/Reel
 Reel \varnothing 330 mm = 10.000 Pieces/Reel



Package Outline

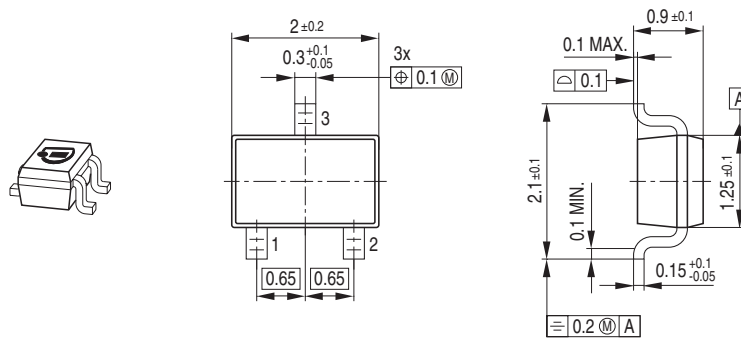

Foot Print

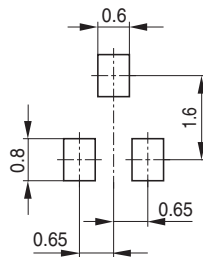

Marking Layout (Example)

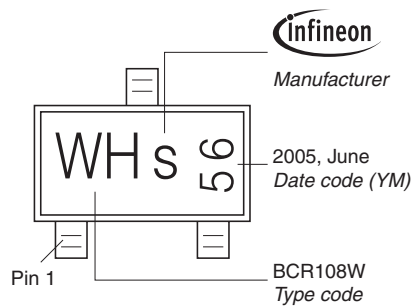

Standard Packing

Reel \varnothing 180 mm = 3.000 Pieces/Reel
 Reel \varnothing 330 mm = 10.000 Pieces/Reel

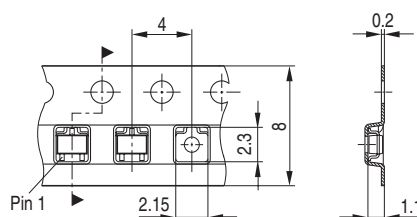

Edition 2009-11-16

**Published by
Infineon Technologies AG
81726 Munich, Germany**

**© 2009 Infineon Technologies AG
All Rights Reserved.**

Legal Disclaimer

The information given in this document shall in no event be regarded as a guarantee of conditions or characteristics. With respect to any examples or hints given herein, any typical values stated herein and/or any information regarding the application of the device, Infineon Technologies hereby disclaims any and all warranties and liabilities of any kind, including without limitation, warranties of non-infringement of intellectual property rights of any third party.

Information

For further information on technology, delivery terms and conditions and prices, please contact the nearest Infineon Technologies Office (www.infineon.com).

Warnings

Due to technical requirements, components may contain dangerous substances. For information on the types in question, please contact the nearest Infineon Technologies Office.

Infineon Technologies components may be used in life-support devices or systems only with the express written approval of Infineon Technologies, if a failure of such components can reasonably be expected to cause the failure of that life-support device or system or to affect the safety or effectiveness of that device or system. Life support devices or systems are intended to be implanted in the human body or to support and/or maintain and sustain and/or protect human life. If they fail, it is reasonable to assume that the health of the user or other persons may be endangered.