

BAT42W, BAT43W

SURFACE MOUNT SCHOTTKY BARRIER DIODE

Features

- Low Forward Voltage Drop
- Fast Switching

PINNING

PIN	DESCRIPTION
1	Cathode
2	Anode

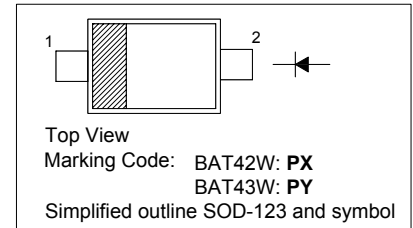

Absolute Maximum Ratings ($T_a = 25\text{ }^\circ\text{C}$)

Parameter	Symbol	Value	Unit
Repetitive Peak Reverse Voltage	V_{RRM}	30	V
Reverse Voltage	V_R	30	V
Forward Continuous Current	I_{FM}	200	mA
Repetitive Peak Forward Current at $t < 1\text{ s}$	I_{FRM}	500	mA
Non-repetitive Peak Forward Surge Current at $t < 10\text{ ms}$	I_{FSM}	2	A
Power Dissipation	P_{tot}	200	mW
Thermal Resistance Junction to Ambient	$R_{\theta JA}$	500	$^\circ\text{C/W}$
Operating and Storage Temperature Range	T_j, T_s	- 55 to + 125	$^\circ\text{C}$

Characteristics at $T_a = 25\text{ }^\circ\text{C}$

Parameter	Symbol	Min.	Max.	Unit	
Reverse Breakdown Voltage at $I_R = 100\text{ }\mu\text{A}$	$V_{(BR)R}$	30	-	V	
Reverse Current at $V_R = 25\text{ V}$	I_R	-	500	nA	
Forward Voltage at $I_F = 200\text{ mA}$	V_F	-	1	V	
at $I_F = 10\text{ mA}$		BAT42W	-	0.4	V
at $I_F = 50\text{ mA}$		BAT42W	-	0.65	V
at $I_F = 2\text{ mA}$		BAT43W	0.26	0.33	V
at $I_F = 15\text{ mA}$		BAT43W	-	0.45	V
Total Capacitance at $V_R = 1\text{ V}$, $f = 1\text{ MHz}$	C_T	-	10	pF	
Reverse Recovery Time at $I_F = I_R = 10\text{ mA}$, $I_{rr} = 0.1 \times I_R$, $R_L = 100\text{ }\Omega$	t_{rr}	-	5	ns	

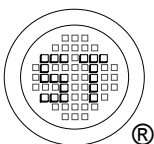

SEMTECH ELECTRONICS LTD.

(Subsidiary of Sino-Tech International Holdings Limited, a company listed on the Hong Kong Stock Exchange, Stock Code: 724)



ISO/TS 16949 : 2002
Certificate No. 05103



ISO 14001:2004
Certificate No. 7116



ISO 9001:2000
Certificate No. 0506098

Dated : 18/04/2008

BAT42W, BAT43W

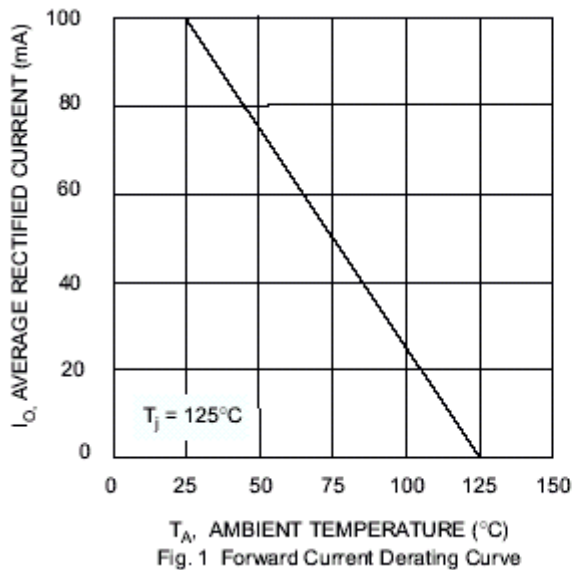

Fig. 1 Forward Current Derating Curve

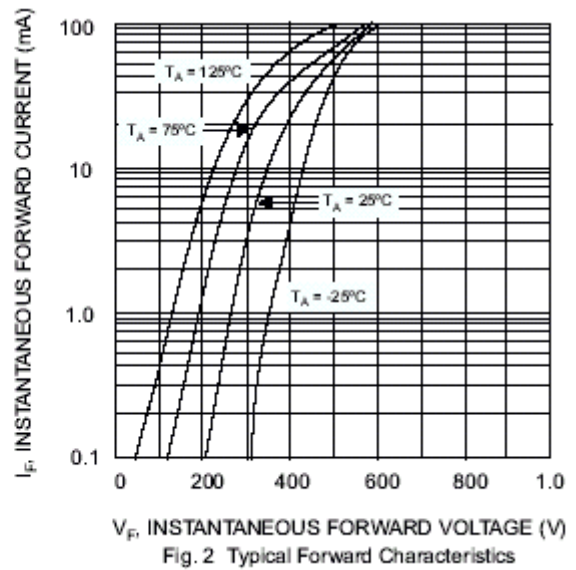

Fig. 2 Typical Forward Characteristics

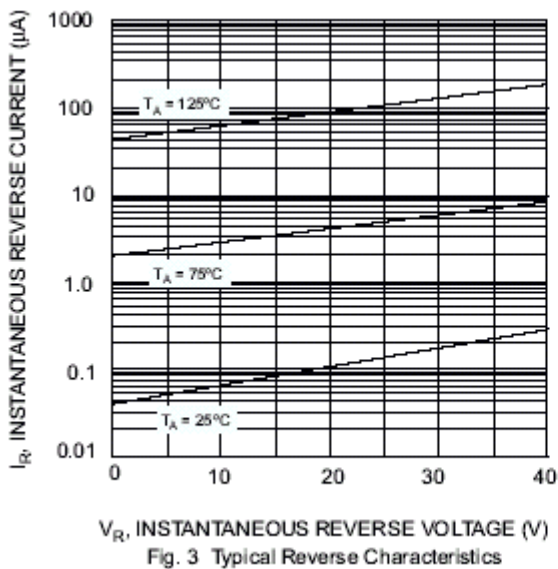

Fig. 3 Typical Reverse Characteristics

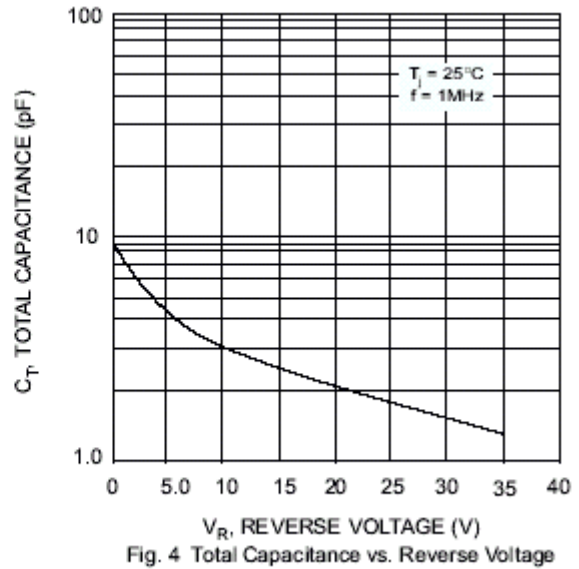
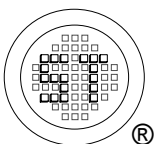

Fig. 4 Total Capacitance vs. Reverse Voltage



SEMTECH ELECTRONICS LTD.

(Subsidiary of Sino-Tech International Holdings Limited, a company listed on the Hong Kong Stock Exchange, Stock Code: 724)



ISO/TS 16949 : 2002
Certificate No. 05103



ISO 14001:2004
Certificate No. 7116



ISO 9001:2000
Certificate No. 0506098

BAT42W, BAT43W

PACKAGE OUTLINE

Plastic surface mounted package; 2 leads

SOD-123

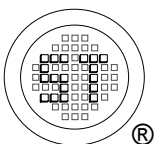
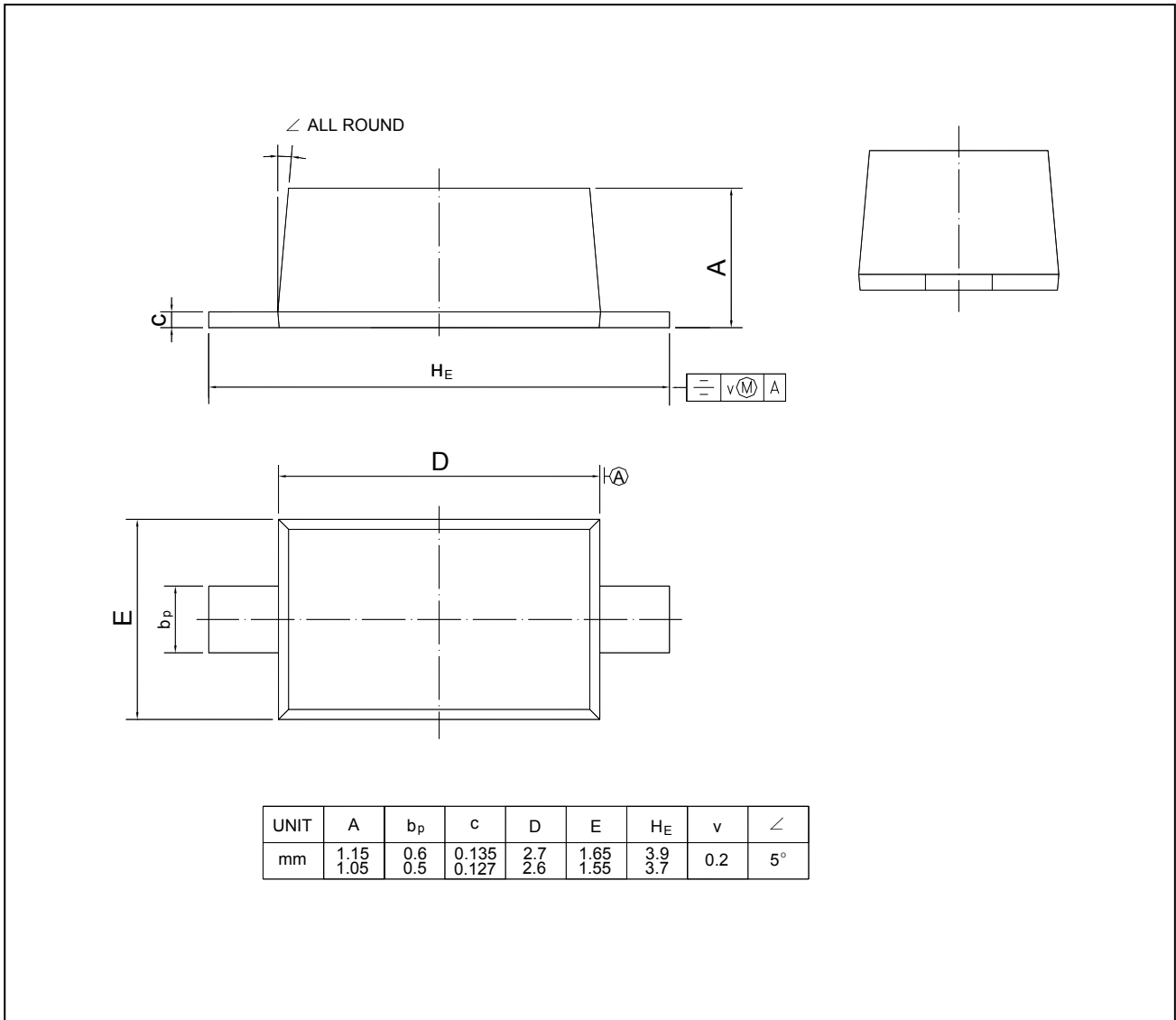

SEMTECH ELECTRONICS LTD.

(Subsidiary of Sino-Tech International Holdings Limited, a company listed on the Hong Kong Stock Exchange, Stock Code: 724)



ISO/TS 16949 : 2002
Certificate No. 05103



ISO 14001:2004
Certificate No. 7116



ISO 9001:2000
Certificate No. 0506098

Dated : 18/04/2008