

## Features

- Low Turn-On Voltage
- Fast Switching Speed
- PN Junction Guard Ring for Transient and ESD Protection
- For General Purpose Switching Applications
- Plastic Material – UL Recognition Flammability Classification 94V-0

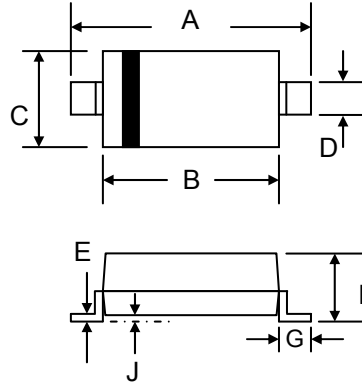

SOD-323		
Dim	Min	Max
A	2.30	2.75
B	1.60	1.80
C	1.15	1.35
D	0.25	0.40
E	0.09	0.18
G	0.20	0.40
H	0.80	1.15
J	—	0.12
All Dimensions in mm		

## Mechanical Data

- Case: SOD-323, Molded Plastic
- Terminals: Plated Leads Solderable per MIL-STD-202, Method 208
- Polarity: Cathode Band
- Weight: 0.004 grams (approx.)
- Marking: Device Code, See Page 3
- **Lead Free: For RoHS / Lead Free Version, Add “-LF” Suffix to Part Number, See Page 4**

## Maximum Ratings @ $T_A=25^\circ\text{C}$ unless otherwise specified

Characteristic	Symbol	BAT42WS	BAT43WS	Unit
Peak Repetitive Reverse Voltage Working Peak Reverse Voltage DC Blocking Voltage	$V_{RRM}$ $V_{RWM}$ $V_R$	30		V
Forward Continuous Current	$I_F$	200		mA
Repetitive Peak Forward Current @ $t < 1.0\text{s}$	$I_{FRM}$	500		mA
Non-Repetitive Peak Forward Surge Current @ $t < 10\text{ms}$	$I_{FSM}$	4.0		A
Operating and Storage Temperature Range	$T_J, T_{STG}$	-55 to +125		$^\circ\text{C}$

## Thermal Characteristics

Characteristic	Symbol	BAT42WS	BAT43WS	Unit
Power Dissipation (Note 1)	$P_D$	200		mW
Thermal Resistance, Junction to Ambient (Note 1)	$R_{JA}$	625		$^\circ\text{C/W}$

Note: 1. Mounted on FR-4 PC board with minimum recommended pad layout.

## Electrical Characteristics @ $T_A=25^\circ\text{C}$ unless otherwise specified

Characteristic	Symbol	BAT42WS	BAT43WS	Unit
Min. Reverse Breakdown Voltage @ $I_R = 100\mu\text{A}$	$V_{(BR)}$	30		V
Max. Forward Voltage Drop @ $I_F = 2.0\text{mA}$ @ $I_F = 10\text{mA}$ @ $I_F = 200\text{mA}$	$V_{FM}$	— 0.4 1.0	0.33 — 1.0	V
Peak Reverse Leakage Current @ $V_R = 25\text{V}, T_J = 25^\circ\text{C}$ @ $V_R = 25\text{V}, T_J = 100^\circ\text{C}$	$I_{RM}$	0.5 100		$\mu\text{A}$
Diode Capacitance ( $V_R = 1.0\text{V}, f = 1.0\text{MHz}$ )	$C_D$	10		pF
Reverse Recovery Time ( $I_F = I_R = 10\text{mA}, I_{RR} = 0.1 \times I_R, R_L = 100\Omega$ )	$t_{rr}$	5.0		nS

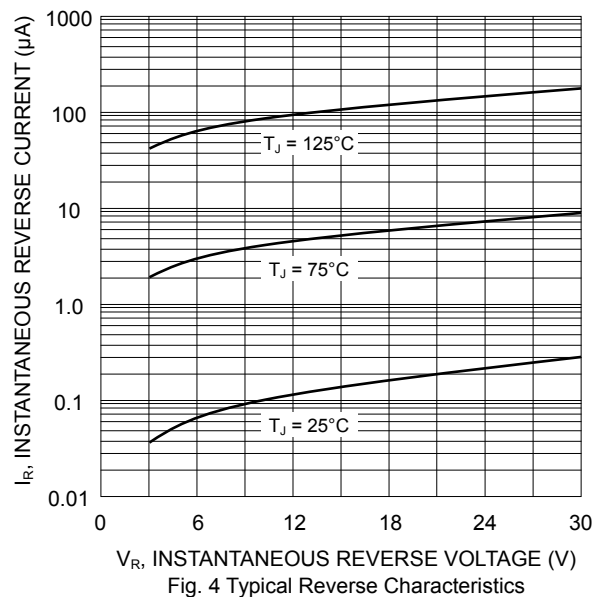
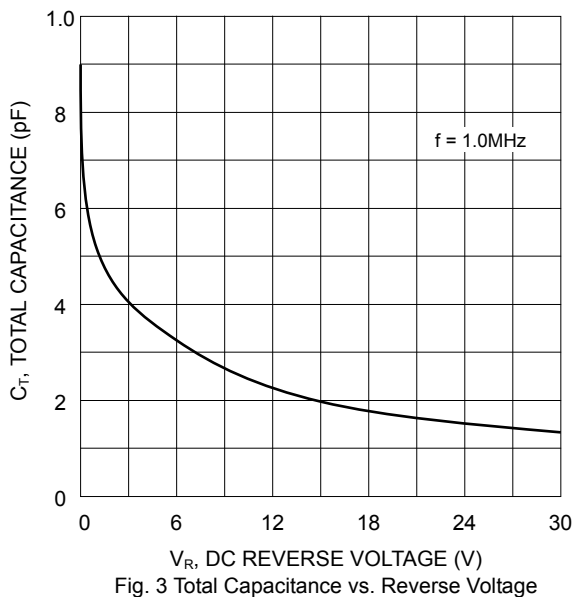
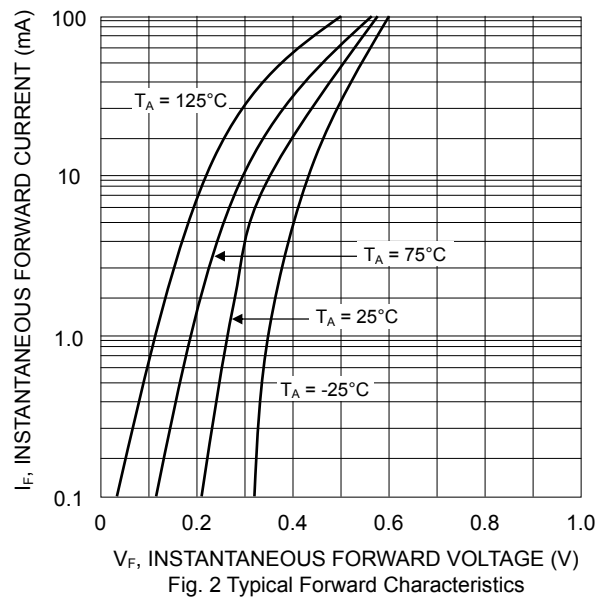
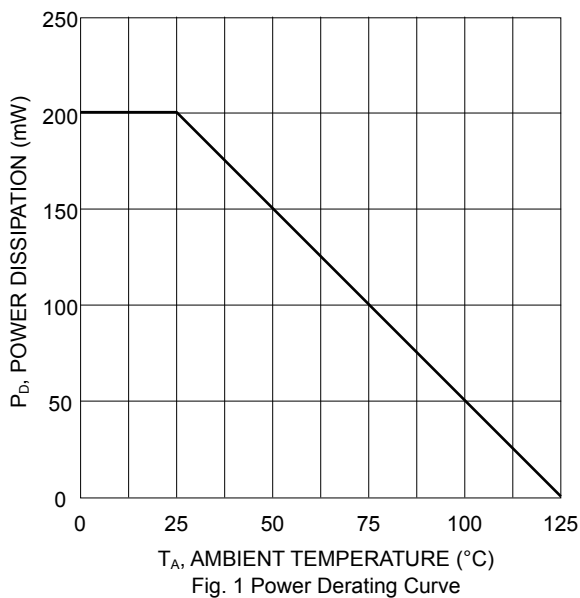

## MARKING INFORMATION



xx = Device Code, See Table Below

Mfg Site	BAT42WS	BAT43WS
TW Plant	L2	L3
CN Plant	S7	S8

## RECOMMENDED FOOTPRINT

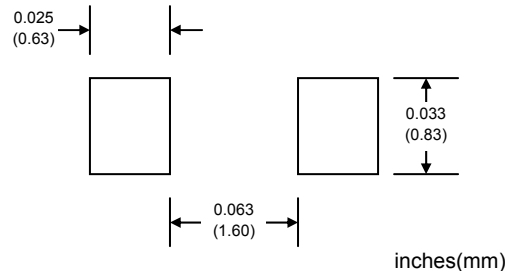

## PACKAGING INFORMATION

### TAPE & REEL

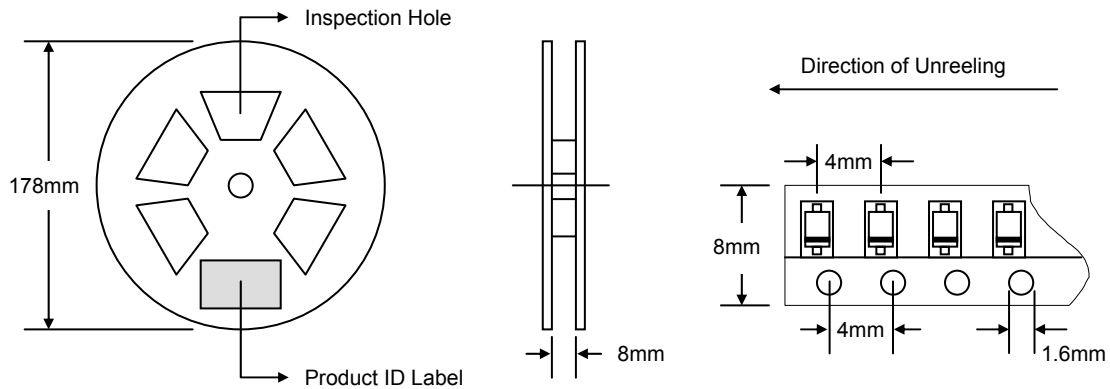

Reel Diameter (mm)	Quantity (PCS)	Inner Box Size L x W x H (mm)	Quantity (PCS)	Carton Size L x W x H (mm)	Quantity (PCS)	Approx. Gross Weight (KG)
178	3,000	187 x 187 x 65	15,000	390 x 240 x 420	150,000	7.0

**Note:** 1. Anti-static plastic reel, white, water clear or blue color. Inspection hole might be varied in different alignment.  
2. Components are packed in accordance with EIA standard 481-1 and 481-2.

## ORDERING INFORMATION

Product No.	Package Type	Shipping Quantity
BAT42WS-T1	SOD-323	3000/Tape & Reel
BAT43WS-T1	SOD-323	3000/Tape & Reel

1. Shipping quantity given is for minimum packing quantity only. For minimum order quantity, please consult the Sales Department.
2. **To order RoHS / Lead Free version (with Lead Free finish), add "-LF" suffix to part number above. For example, BAT42WS-T1-LF.**

WON-TOP ELECTRONICS and  are registered trademarks of Won-Top Electronics Co., Ltd (WTE). WTE has checked all information carefully and believes it to be correct and accurate. However, WTE cannot assume any responsibility for inaccuracies. Furthermore, this information does not give the purchaser of semiconductor devices any license under patent rights to manufacturer. WTE reserves the right to change any or all information herein without further notice.

**WARNING:** DO NOT USE IN LIFE SUPPORT EQUIPMENT. WTE power semiconductor products are not authorized for use as critical components in life support devices or systems without the express written approval.

**Won-Top Electronics Co., Ltd.**  
No. 44 Yu Kang North 3rd Road,  
Chine Chen Dist., Kaohsiung 806, Taiwan  
**Phone:** 886-7-822-5408 or 886-7-822-5410  
**Fax:** 886-7-822-5417  
**Email:** sales@wontop.com  
**Internet:** <http://www.wontop.com>

*We power your everyday.*