



Micro Commercial Components
 21201 Itasca Street Chatsworth
 CA 91311
 Phone: (818) 701-4933
 Fax: (818) 701-4939

BAT54 THRU BAT54S

Features

- Low Forward Voltage
- Surface Mount device
- Very small conduction losses

250mWatt, 30Volt Schottky Barrier Diode

MCC Catalog Number	Device Marking	Type	Pin Configuration (See Page 3)
BAT54	L4P	Single	Figure 1
BAT54A	L42	Dual	Figure 2
BAT54C	L43	Dual	Figure 3
BAT54S	L44	Dual	Figure 4

Maximum Ratings

Continuos Reverse Voltage	V_R	30V
Forward Current	I_F	0.3A
Non-Repetitive Peak Forward Current $t < 1s$	I_{FSM}	1.0mA
Total Power Dissipation @ $T_A = 25^\circ C$	P_D	250mW
Storage Temperature Range	T_{stg}	$-55^\circ C$ to $150^\circ C$
Junction Temperature	T_j	$150^\circ C$
Soldering temperature during 10s	T_j	$260^\circ C$

Electrical Characteristics @ 25 °C Unless Otherwise Specified

Ratings	Symbol	Max.	Notes
Forward Voltage at $I_F = 0.1mA$ $I_F = 1mA$ $I_F = 10mA$ $I_F = 30mA$ $I_F = 100mA$	V_F	240mV 320mV 400mV 500mV 900mV	
Reverse Current	I_R	2.0 uA	$V_R = 25V$
Reverse Breakdown Voltage	$V_{(BR)}$	>30V	
Capacitance	C_J	10pF	Measured at 1.0MHz, $V_R = 1.0V$
Reverse Recovery Time	t_{rr}	5nS	$I_F = I_R = 10mA$; $I_{(REC)} = 1mA$
Thermal Resistance, Junction to Ambient	$R_{\theta JA}$	500K/W	

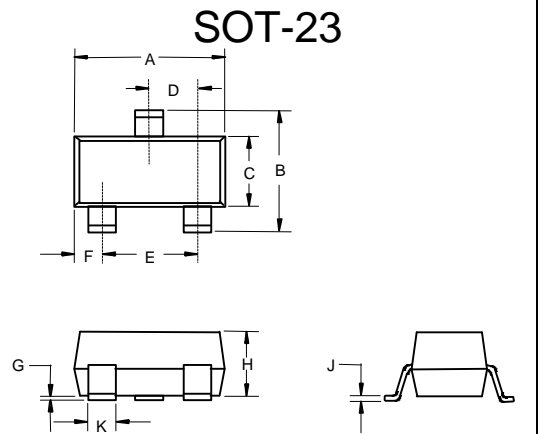

DIM	INCHES		MM		NOTE
	MIN	MAX	MIN	MAX	
A	.110	.120	2.80	3.04	
B	.083	.098	2.10	2.64	
C	.047	.055	1.20	1.40	
D	.035	.041	.89	1.03	
E	.070	.081	1.78	2.05	
F	.018	.024	.45	.60	
G	.0005	.0039	.013	.100	
H	.035	.044	.89	1.12	
J	.003	.007	.085	.180	
K	.015	.020	.37	.51	

Suggested Solder Pad Layout

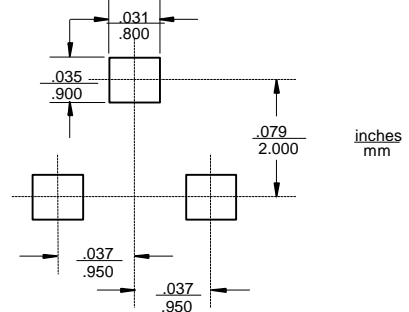

Fig.1 : Average forward power dissipation versus average forward current.

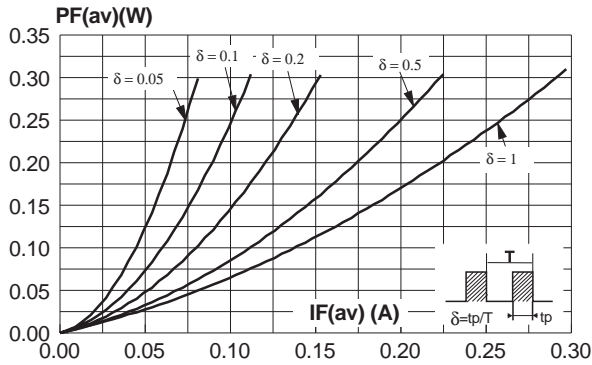

Fig.2 : Average forward current versus ambient temperature ($\delta = 1$).

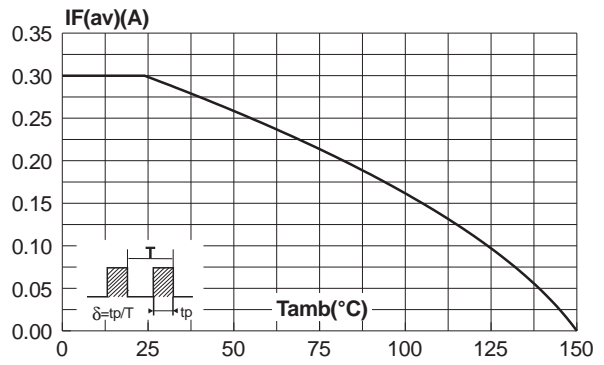

Fig.3 : Non repetitive surge peak forward current versus overload duration (maximum values).

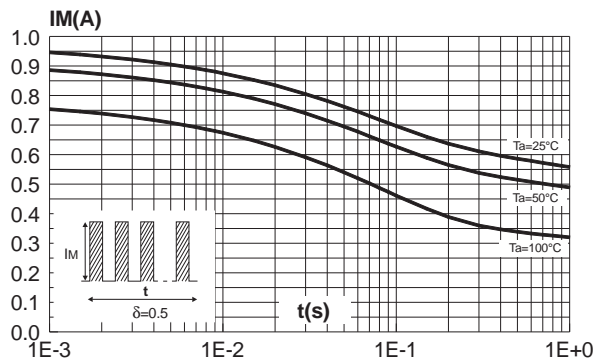
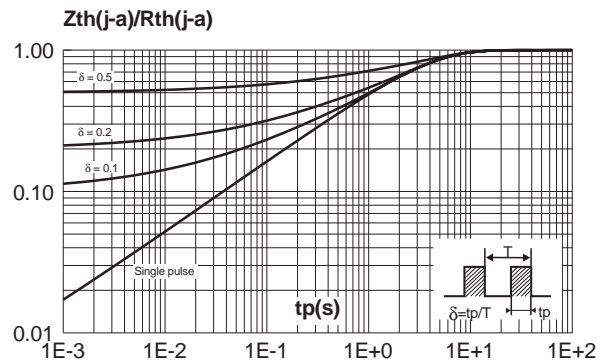

Fig.4 : Relative variation of thermal impedance junction to ambient versus pulse duration (alumine substrate 10mm x 8mm x 0.5mm).



BAT54 thru BAT54S



Fig.5 : Reverse leakage current versus reverse voltage applied (typical values).

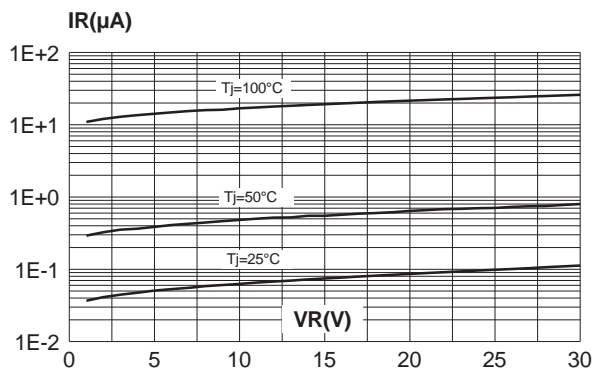

Fig.6 : Reverse leakage current versus junction temperature.

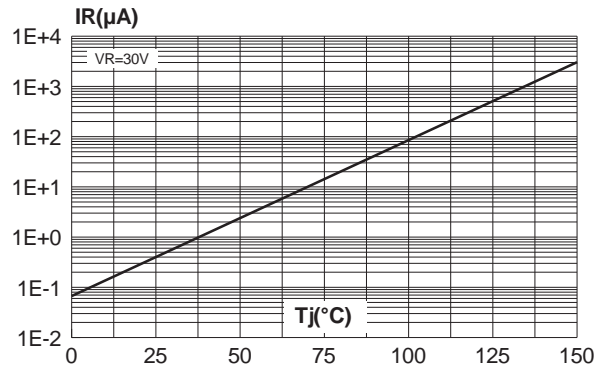

Fig.7 : Junction capacitance versus reverse voltage applied (typical values).

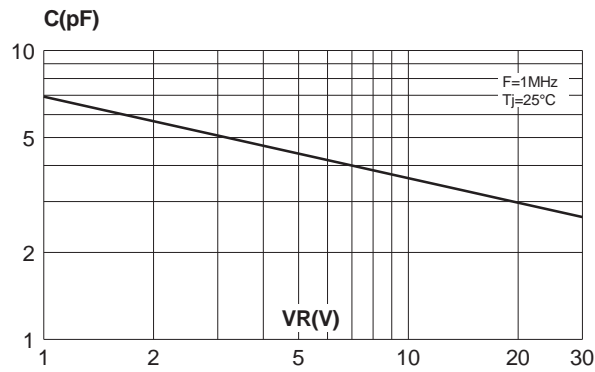
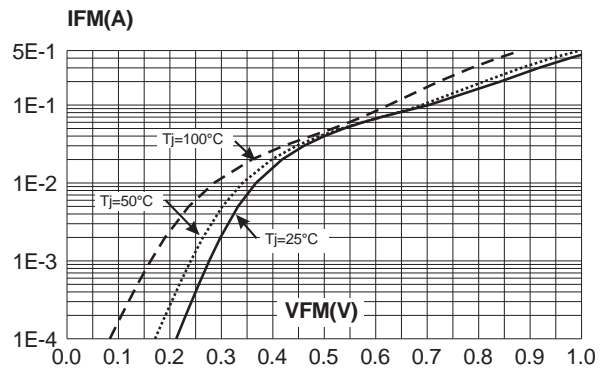

Fig.8 : Forward voltage drop versus forward current (typical values).



Pin Configuration - Top View

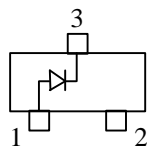

Figure 1

BAT54

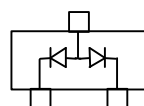

Figure 2

BAT54A

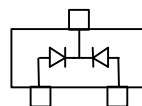

Figure 3

BAT54C

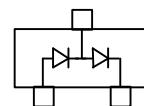

Figure 4

BAT54S