

## SOT-523 Plastic-Encapsulate Diodes

### BAT54T/AT/CT/ST SCHOTTKY BARRIER DIODE

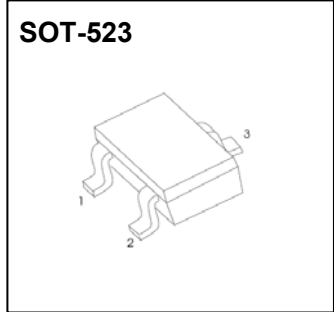

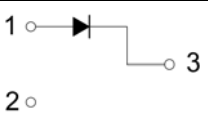
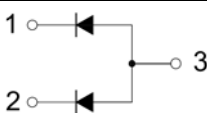
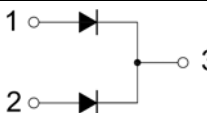
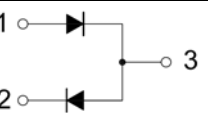

#### FEATURES

- Low Forward Voltage Drop
- Fast Switching
- PN Junction Guard Ring for Transient and ESD Protection

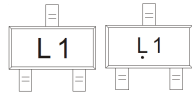

BAT54T	BAT54AT	BAT54CT	BAT54ST
			

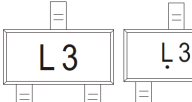
#### MARKING:

BAH) ( H	BAH) ( 5 H	BAH) ( 7 H	BAH) ( GH
			

Solid dot = Green molding compound device, if none, the normal device.

#### MAXIMUM RATINGS ( $T_a=25^{\circ}\text{C}$ unless otherwise noted )

Symbol	Parameter	Value	Unit
$V_{RRM}$	Peak Repetitive Reverse Voltage	30	V
$V_{RWM}$	Working Peak Reverse Voltage		
$V_{R(RMS)}$	RMS Reverse Voltage	21	V
$I_o$	Average Rectified Output Current	0.2	A
$I_{FSM}$	Non-repetitive Peak Forward Surge Current @ $t=8.3\text{ms}$	600	mA
$I_{FRM}$	Repetitive Peak Forward Surge Current @ $t \leq 1\text{s}; \delta \leq 0.5$	300	mA
$P_D$	Power Dissipation	150	mW
$R_{\theta JA}$	Thermal Resistance from Junction to Ambient	667	$^{\circ}\text{C}/\text{W}$
$T_j$	Junction Temperature	125	$^{\circ}\text{C}$
$T_{stg}$	Storage Temperature	-55~+150	$^{\circ}\text{C}$

#### ELECTRICAL CHARACTERISTICS ( $T_a=25^{\circ}\text{C}$ unless otherwise specified)

Parameter	Symbol	Test conditions	Min	Typ	Max	Unit
Reverse voltage	$V_{(BR)}$	$I_R=100\mu\text{A}$	30			V
Reverse current	$I_R$	$V_R=25\text{V}$			2	$\mu\text{A}$
Forward voltage	$V_F$	$I_F=1\text{mA}$			0.32	V
		$I_F=10\text{mA}$			0.4	
		$I_F=30\text{mA}$			0.5	
		$I_F=100\text{mA}$			1	
Total capacitance	$C_{tot}$	$V_R=1\text{V}, f=1\text{MHz}$			10	pF
Reverse recovery time	$t_{rr}$	$I_F=I_R=10\text{mA}, I_{rr}=0.1 \times I_R, R_L=100\Omega$			5	ns

# Typical Characteristics

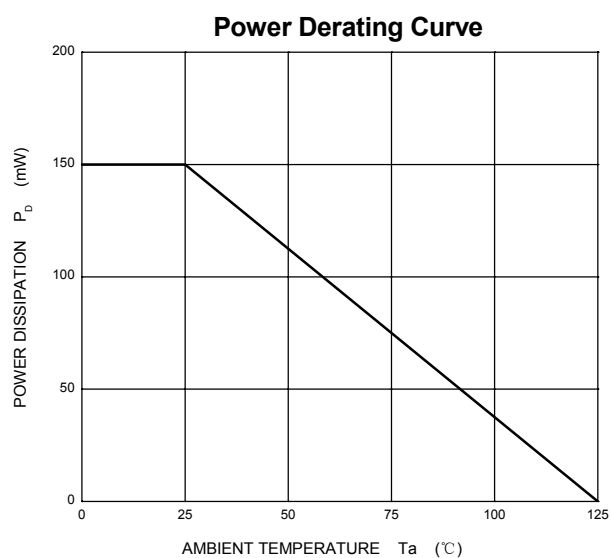
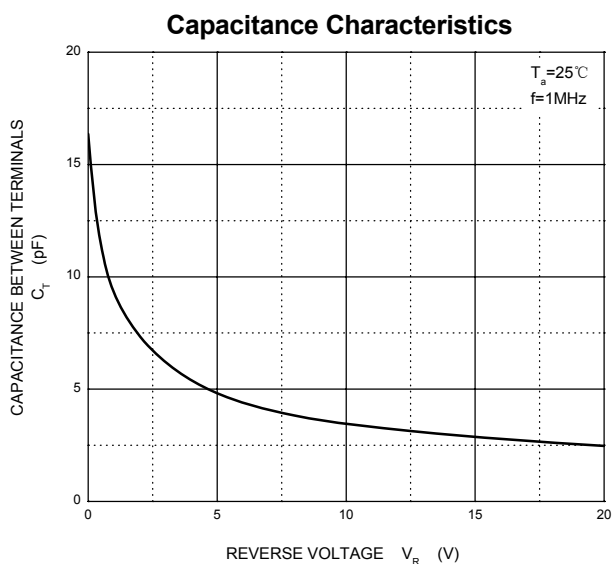
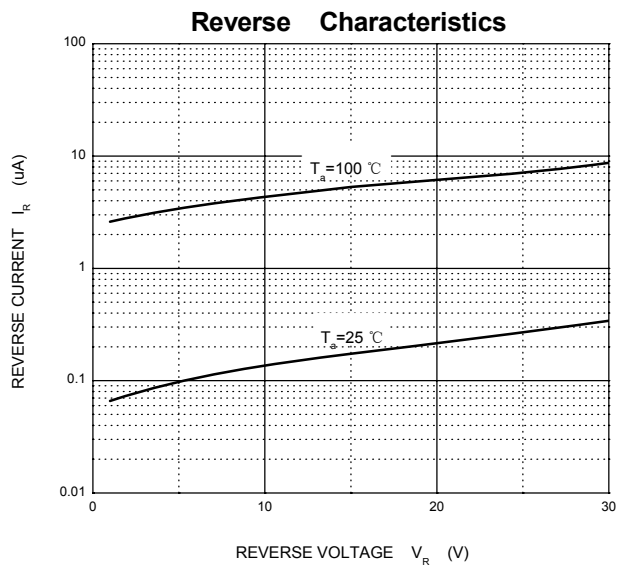
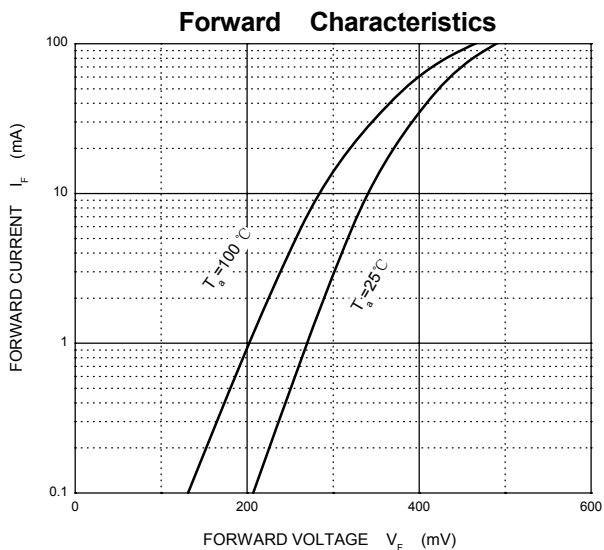

## SOT-523 Package Outline Dimensions

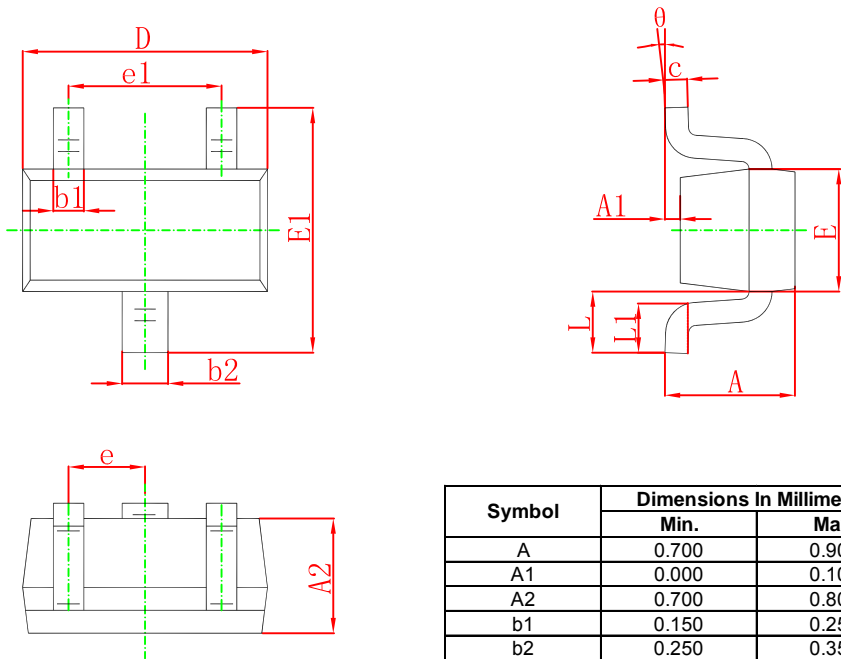

Symbol	Dimensions In Millimeters		Dimensions In Inches	
	Min.	Max.	Min.	Max.
A	0.700	0.900	0.028	0.035
A1	0.000	0.100	0.000	0.004
A2	0.700	0.800	0.028	0.031
b1	0.150	0.250	0.006	0.010
b2	0.250	0.350	0.010	0.014
c	0.100	0.200	0.004	0.008
D	1.500	1.700	0.059	0.067
E	0.700	0.900	0.028	0.035
E1	1.450	1.750	0.057	0.069
e	0.500 TYP.		0.020 TYP.	
e1	0.900	1.100	0.035	0.043
L	0.400 REF.		0.016 REF.	
L1	0.260	0.460	0.010	0.018
θ	0°	8°	0°	8°

## SOT-523 Suggested Pad Layout

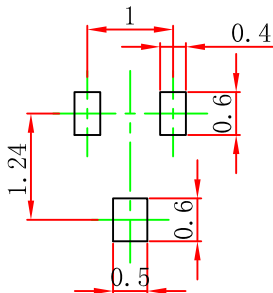

- Note:
1. Controlling dimension: in millimeters.
  2. General tolerance:  $\pm 0.05\text{mm}$ .
  3. The pad layout is for reference purposes only.

### NOTICE

JCET reserve the right to make modifications, enhancements, improvements, corrections or other changes without further notice to any product herein. JCET does not assume any liability arising out of the application or use of any product described herein.

# SOT-523 Tape and Reel

## SOT-523 Embossed Carrier Tape

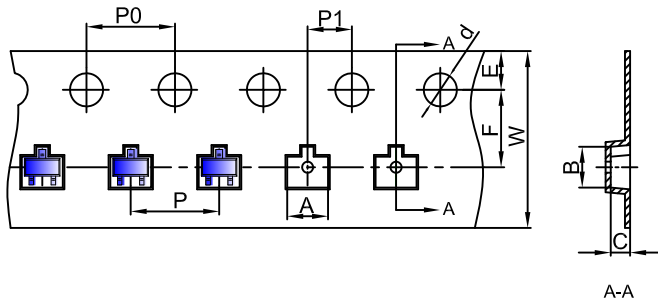

### Packaging Description:

SOT-523 parts are shipped in tape. The carrier tape is made from a dissipative (carbon filled) polycarbonate resin. The cover tape is a multilayer film (Heat Activated Adhesive in nature) primarily composed of polyester film, adhesive layer, sealant, and anti-static sprayed agent. These reeled parts in standard option are shipped with 3,000 units per 7" or 17.8cm diameter reel. The reels are clear in color and is made of polystyrene plastic (anti-static coated).

Dimensions are in millimeter

Pkg type	A	B	C	d	E	F	P0	P	P1	W
SOT-523	1.85	1.85	0.875	Ø1.50	1.75	3.50	4.00	4.00	2.00	8.00

## SOT-523 Tape Leader and Trailer

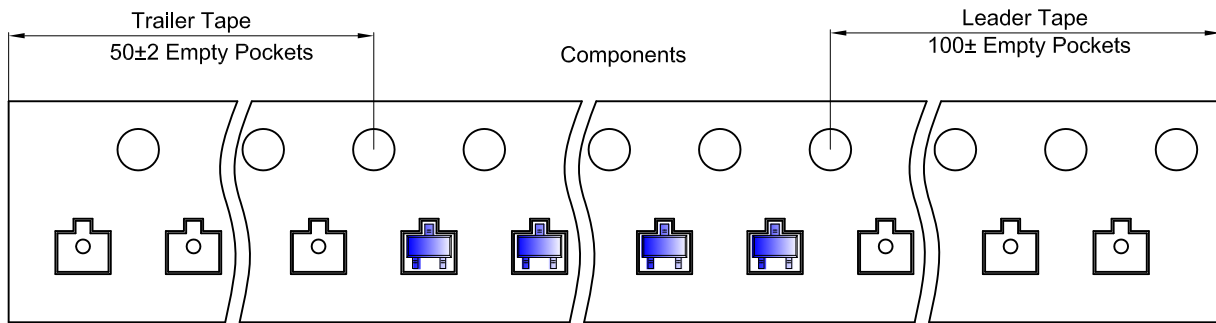

## SOT-523 Reel

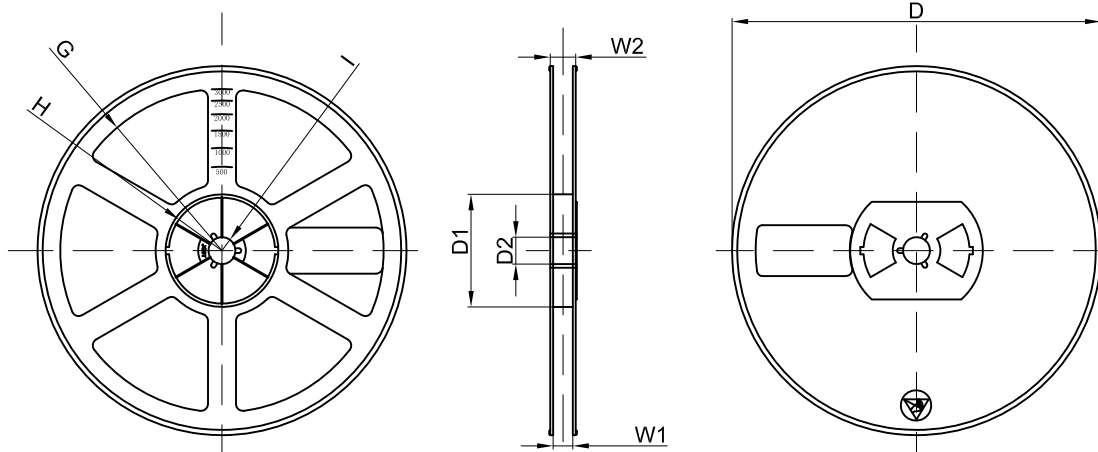

Dimensions are in millimeter

Reel Option	D	D1	D2	G	H	I	W1	W2
7" Dia	Ø178.00	54.40	13.00	R78.00	R25.60	R6.50	9.50	12.30

REEL	Reel Size	Box	Box Size(mm)	Carton	Carton Size(mm)	G.W.(kg)
3000 pcs	7 inch	45,000 pcs	203×203×195	180,000 pcs	438×438×220	