

Small Signal Schottky Diode

Features

- These diodes feature very low turn-on voltage and fast switching
- These devices are protected by a PN junction guard ring against excessive voltage, such as electrostatic discharges
- AEC-Q101 qualified
- Compliant to RoHS directive 2002/95/EC and in accordance to WEEE 2002/96/EC



RoHS
COMPLIANT

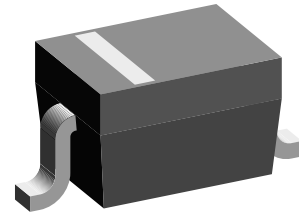

20145

Mechanical Data

Case: SOD-323

Weight: approx. 4.3 mg

Packaging codes/options:

GS18/10k per 13" reel (8 mm tape), 10k/box

GS08/3k per 7" reel (8 mm tape), 15k/box

Parts Table

Part	Ordering code	Type marking	Remarks
BAT54WS-V	BAT54WS-V-GS18 or BAT54WS-V-GS08	L4	Tape and reel

Absolute Maximum Ratings

$T_{amb} = 25\text{ }^{\circ}\text{C}$, unless otherwise specified

Parameter	Test condition	Symbol	Value	Unit
Repetitive peak reverse voltage		V_{RRM}	30	V
Forward continuous current		I_F	200 ¹⁾	mA
Repetitive peak forward current		I_{FRM}	300 ¹⁾	mA
Surge forward current	$t_p < 1\text{ s}$	I_{FSM}	600 ¹⁾	mA
Power dissipation ¹⁾		P_{tot}	150 ¹⁾	mW

Note

¹⁾ Valid provided that electrodes are kept at ambient temperature

Thermal Characteristics

$T_{amb} = 25\text{ }^{\circ}\text{C}$, unless otherwise specified

Parameter	Test condition	Symbol	Value	Unit
Thermal resistance junction to ambient air		R_{thJA}	650 ¹⁾	K/W
Maximum junction temperature		T_j	125	$^{\circ}\text{C}$
Storage temperature range		T_{stg}	- 65 to + 150	$^{\circ}\text{C}$

Note

¹⁾ Valid provided that electrodes are kept at ambient temperature

Electrical Characteristics

$T_{amb} = 25\text{ }^{\circ}\text{C}$, unless otherwise specified

Parameter	Test condition	Symbol	Min.	Typ.	Max.	Unit
Reverse breakdown voltage	tested with 100 μA pulses	$V_{(BR)}$	30			V
Leakage current ¹⁾	$V_R = 25\text{ V}$	I_R			2	μA
Forward voltage ¹⁾	$I_F = 0.1\text{ mA}$	V_F			240	mV
	$I_F = 1\text{ mA}$	V_F			320	mV
	$I_F = 10\text{ mA}$	V_F			400	mV
	$I_F = 30\text{ mA}$	V_F			500	mV
	$I_F = 100\text{ mA}$	V_F			800	mV
Diode capacitance	$V_R = 1\text{ V}$, $f = 1\text{ MHz}$	C_D			10	pF
Reverse recovery time	$I_F = I_R = 10\text{ mA}$; $I_R = 1\text{ mA}$; $R_L = 100\ \Omega$	t_{rr}			5	ns

Note

¹⁾ Pulse test: $t_p < 300\ \mu\text{s}$, $\theta < 2\%$

Typical Characteristics

$T_{amb} = 25\text{ }^{\circ}\text{C}$, unless otherwise specified

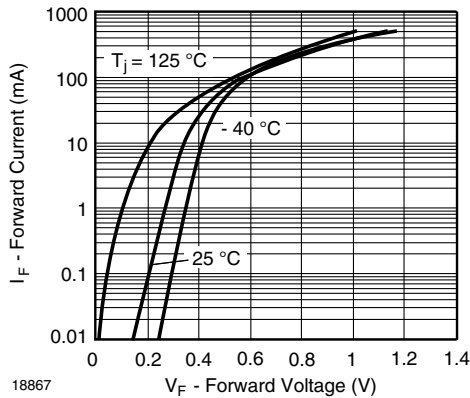

Figure 1. Typical Forward Current vs. Forward Voltage vs. Various Temperatures

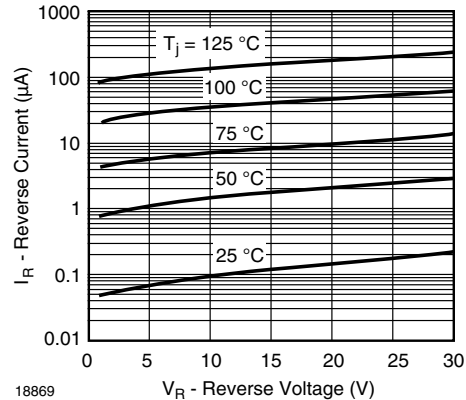

Figure 3. Typical Reverse Current vs. Reverse Voltage vs. Various Temperatures

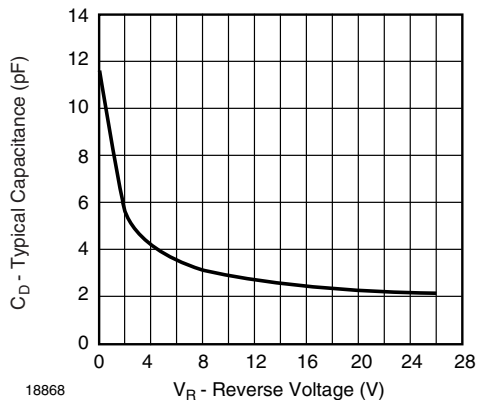
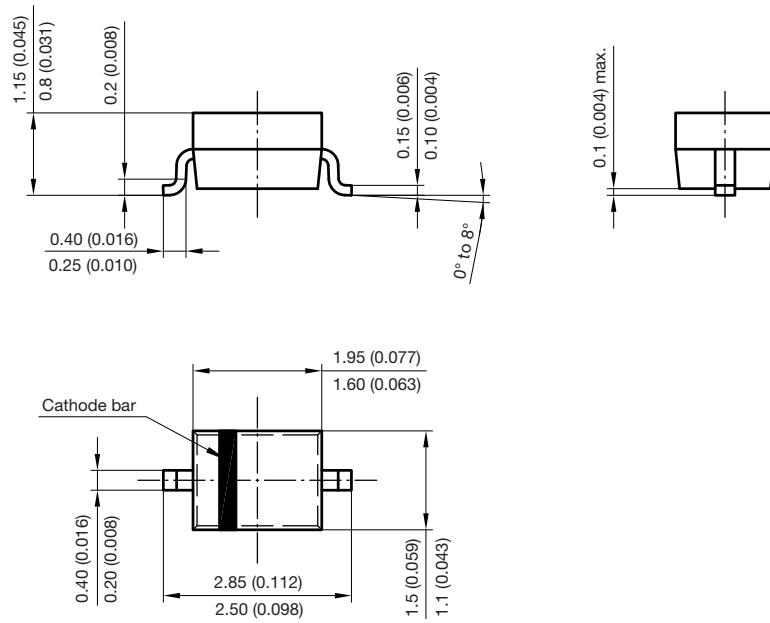
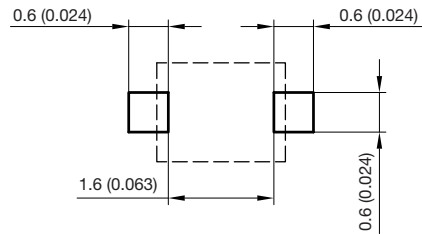

Figure 2. Typical Capacitance vs. Reverse Applied Voltage

Package Dimensions in millimeters (inches): **SOD-323**



Foot print recommendation:



Document no.:S8-V-3910.02-001 (4)
 Created - Date: 24.August.2004
 Rev. 5 - Date: 23.Sept.2009
 17443

PACKAGE DIMENSIONS in millimeters (inches)

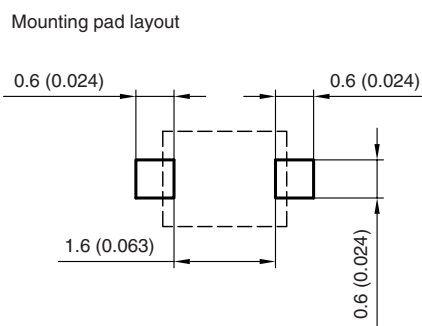
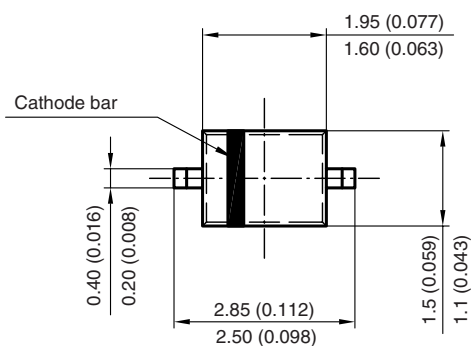
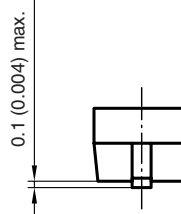
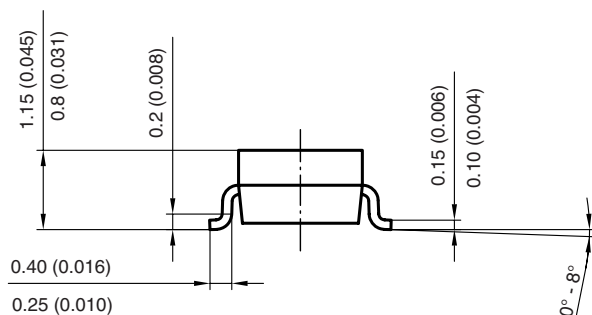

Created - Date: 24. August. 2004
 Rev. 04 - Date: 23. Sep. 2009
 Document no.: S8-V-3910.02-001 (4)
 17443



Disclaimer

ALL PRODUCT, PRODUCT SPECIFICATIONS AND DATA ARE SUBJECT TO CHANGE WITHOUT NOTICE TO IMPROVE RELIABILITY, FUNCTION OR DESIGN OR OTHERWISE.

Vishay Intertechnology, Inc., its affiliates, agents, and employees, and all persons acting on its or their behalf (collectively, "Vishay"), disclaim any and all liability for any errors, inaccuracies or incompleteness contained in any datasheet or in any other disclosure relating to any product.

Vishay makes no warranty, representation or guarantee regarding the suitability of the products for any particular purpose or the continuing production of any product. To the maximum extent permitted by applicable law, Vishay disclaims (i) any and all liability arising out of the application or use of any product, (ii) any and all liability, including without limitation special, consequential or incidental damages, and (iii) any and all implied warranties, including warranties of fitness for particular purpose, non-infringement and merchantability.

Statements regarding the suitability of products for certain types of applications are based on Vishay's knowledge of typical requirements that are often placed on Vishay products in generic applications. Such statements are not binding statements about the suitability of products for a particular application. It is the customer's responsibility to validate that a particular product with the properties described in the product specification is suitable for use in a particular application. Parameters provided in datasheets and/or specifications may vary in different applications and performance may vary over time. All operating parameters, including typical parameters, must be validated for each customer application by the customer's technical experts. Product specifications do not expand or otherwise modify Vishay's terms and conditions of purchase, including but not limited to the warranty expressed therein.

Except as expressly indicated in writing, Vishay products are not designed for use in medical, life-saving, or life-sustaining applications or for any other application in which the failure of the Vishay product could result in personal injury or death. Customers using or selling Vishay products not expressly indicated for use in such applications do so at their own risk and agree to fully indemnify and hold Vishay and its distributors harmless from and against any and all claims, liabilities, expenses and damages arising or resulting in connection with such use or sale, including attorneys fees, even if such claim alleges that Vishay or its distributor was negligent regarding the design or manufacture of the part. Please contact authorized Vishay personnel to obtain written terms and conditions regarding products designed for such applications.

No license, express or implied, by estoppel or otherwise, to any intellectual property rights is granted by this document or by any conduct of Vishay. Product names and markings noted herein may be trademarks of their respective owners.