

SILICON PLANAR SCHOTTKY DIODES

**BAT64, BAT64-04
 BAT64-05, BAT64-06**

**SOT-23
 Formed SMD Package**

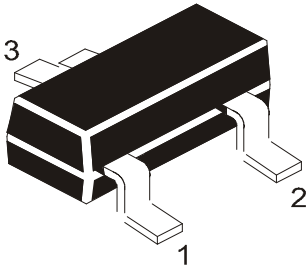

BAT64

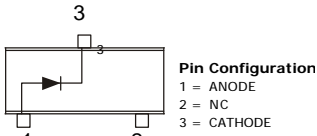

BAT64-04

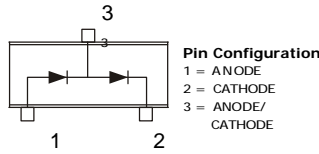

BAT64-05

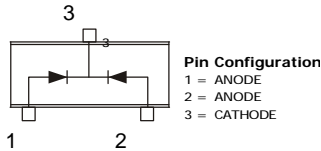

BAT64-06

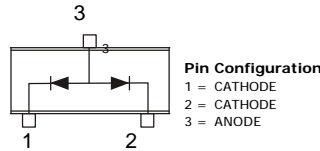

MARKING

- BAT64=63
- BAT64-04=64
- BAT64-05=65
- BAT64-06=66

For Low-Loss, Fast Recovery, Meter Protection, Bias Isolation and Clamping Application

ABSOLUTE MAXIMUM RATINGS at $T_a=25^\circ\text{C}$ (per diode)

DESCRIPTION	SYMBOL	VALUE	UNIT
Reverse Voltage	V_R	40	V
Forward Current	I_F	250	mA
Surge Forward Current $t=10\text{ms}$	I_{FSM}	800	mA
Average Forward Current (50/60Hz, sinus)	$I_{F(AV)}$	120	mA
Power Dissipation	P_D		
BAT64 $T_s \leq 86^\circ\text{C}$		250	mW
BAT64-04, BAT64-06 $T_s \leq 61^\circ\text{C}$		250	mW
BAT64-05 $T_s \leq 36^\circ\text{C}$		250	mW
Storage Temperature Range	T_{stg}	- 55 to +150	$^\circ\text{C}$
Junction Temperature	T_j	150	$^\circ\text{C}$

THERMAL RESISTANCE

	$*R_{th(j-s)}$		
Junction to Soldering Point			
BAT64		255	K/W
BAT64-04, BAT64-06		355	K/W
BAT64-05		455	K/W

* $R_{th(j-s)}$ For calculation of $R_{th(j-a)}$ please refer to Application Note Thermal Resistance

BAT64_06REV081105E

SILICON PLANAR SCHOTTKY DIODES

**BAT64, BAT64-04
BAT64-05, BAT64-06**

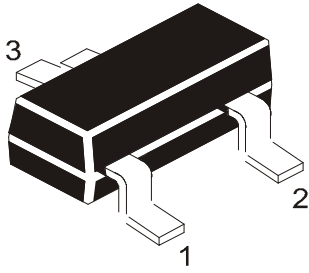

**SOT-23
Formed SMD Package**

ELECTRICAL CHARACTERISTICS ($T_a=25^\circ\text{C}$ unless specified otherwise) (per diode)

DESCRIPTION	SYMBOL	TEST CONDITION	MIN	MAX	UNIT
Reverse Breakdown Voltage	$V_{(BR)}$	$I_{(BR)}=10\mu\text{A}$	40		V
Reverse Current	I_R	$V_R=30\text{V}$ $V_R=30, T_a=85^\circ\text{C}$		2 200	μA μA
Forward Voltage	V_F	$I_F=1\text{mA}$ $I_F=10\text{mA}$ $I_F=30\text{mA}$ $I_F=100\text{mA}$	0.25 0.31 0.37 0.50	0.32 0.43 0.52 0.75	V V V V
Diode Capacitance	C_T	$V_R=1\text{V}, f=1\text{MHz}$		7.00	pF
Reverse Recovery Time	t_{rr}	$I_F=10\text{mA}, I_R=10\text{mA}$, measured $I_R=1\text{mA}$, $R_L=100\Omega$		5.00	ns

BAT64_06REV081105E

SOT-23 Formed SMD Package

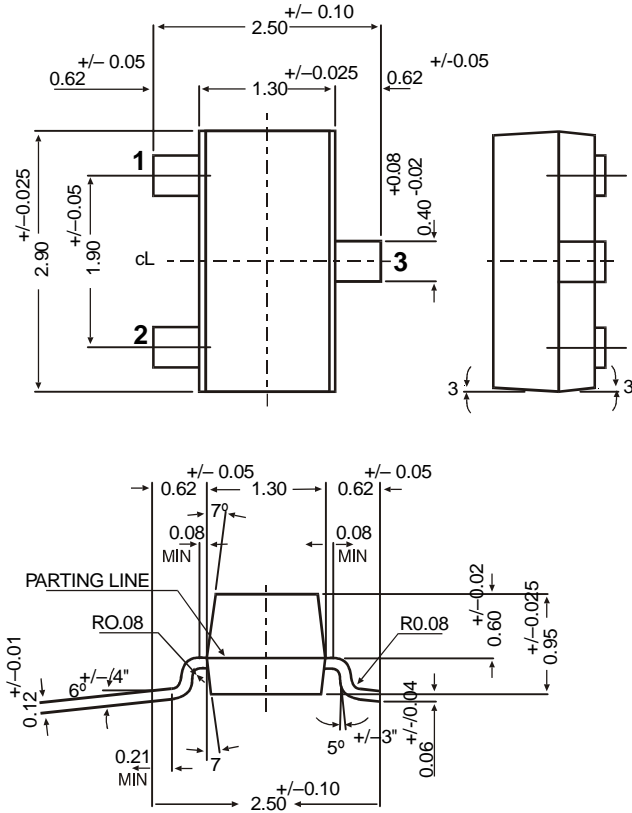

SOT-23 Package Reel Information
Reel specifications for Packing (13"/7" reels)

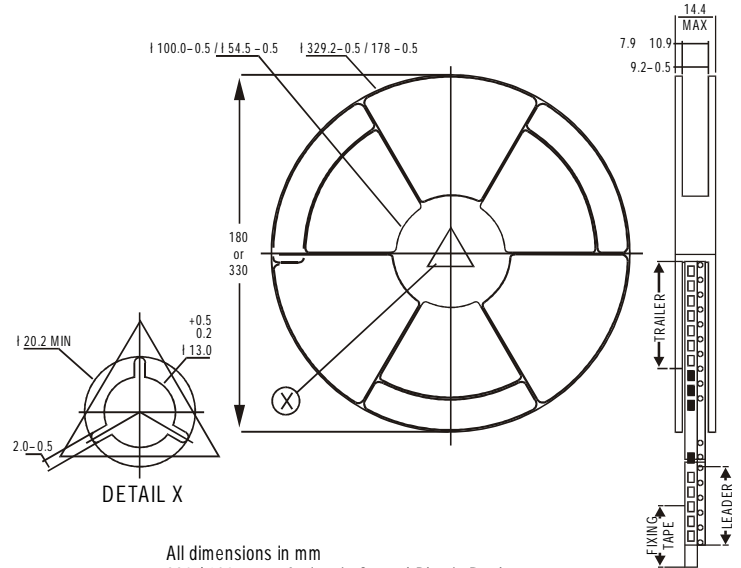

All dimensions in mm
330 / 180 mm Antistatic Coated Plastic Reel

NOTES:

No. of Devices	8mm Tape Size of Reel 330 mm (13") 10,000 Pcs	8mm Tape Size of Reel 180 mm (7") 3,000 Pcs
----------------	--	--

- The bandolier of 330 mm reel contains at least 10,000 devices.
- The bandolier of 180 mm reel contains at least 3,000 devices.
- No more than 0.5% missing devices / reel. 50 empty compartments for 330 mm reel. 15 empty compartments for 180 mm reel.
- Three consecutive empty places might be found provided this gap is followed by 6 consecutive devices.
- The carrier tape (leader) starts with at least 75 empty positions (equivalent to 330 mm). In order to fix the carrier tape a self adhesive tape of 20 to 50 mm is applied. At the end of the bandolier at least 40 empty positions (equivalent to 160 mm) are there.

Tape Specification for SOT-23 Surface Mount Device

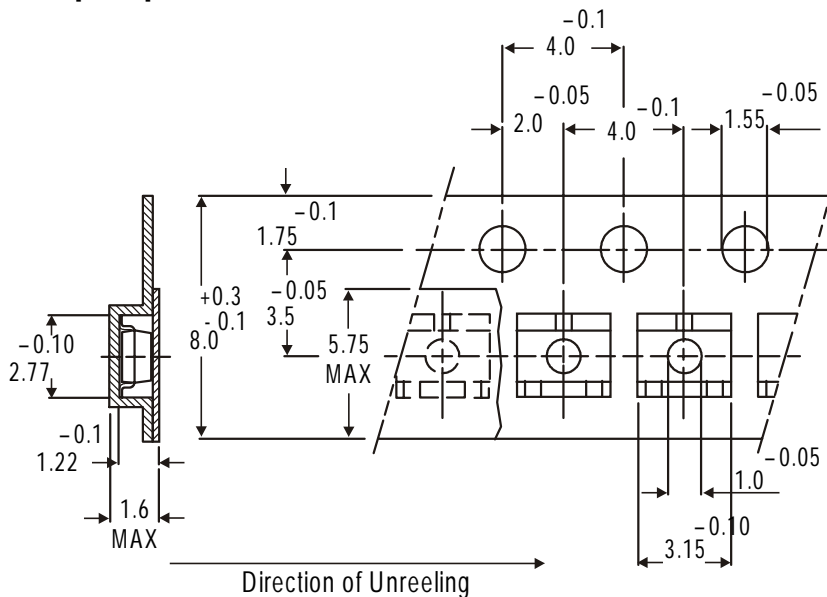

All dimensions in mm

Packing Detail

PACKAGE	STANDARD PACK		INNER CARTON BOX		OUTER CARTON BOX		
	Details	Net Weight/Qty	Size	Qty	Size	Qty	Gr Wt
SOT-23 T&R	3K/reel	136 gm/3K pcs	3" x 7.5" x 7.5"	12.0K	17" x 15" x 13.5"	192.0K	12 kgs
			9" x 9" x 9"	51.0K	19" x 19" x 19"	408.0K	28 kgs
	10K/reel	415 gm/10K pcs	13" x 13" x 0.5"	10.0K	17" x 15" x 13.5"	300.0K	16 kgs

Customer Notes

Component Disposal Instructions

1. CDIL Semiconductor Devices are RoHS compliant, customers are requested to please dispose as per prevailing Environmental Legislation of their Country.
2. In Europe, please dispose as per EU Directive 2002/96/EC on Waste Electrical and Electronic Equipment (WEEE).

Disclaimer

The product information and the selection guides facilitate selection of the CDIL's Semiconductor Device(s) best suited for application in your product(s) as per your requirement. It is recommended that you completely review our Data Sheet(s) so as to confirm that the Device(s) meet functionality parameters for your application. The information furnished on the CDIL Web Site/CD are believed to be accurate and reliable. CDIL however, does not assume responsibility for inaccuracies or incomplete information. Furthermore, CDIL does not assume liability whatsoever, arising out of the application or use of any CDIL product; neither does it convey any license under its patent rights nor rights of others. These products are not designed for use in life saving/support appliances or systems. CDIL customers selling these products (either as individual Semiconductor Devices or incorporated in their end products), in any life saving/support appliances or systems or applications do so at their own risk and CDIL will not be responsible for any damages resulting from such sale(s).

CDIL strives for continuous improvement and reserves the right to change the specifications of its products without prior notice.



CDIL is a registered Trademark of
Continental Device India Limited

C-120 Naraina Industrial Area, New Delhi 110 028, India.

Telephone + 91-11-2579 6150, 4141 1112 Fax + 91-11-2579 5290, 4141 1119

email@cdil.com www.cdilsemi.com