

Silicon Schottky Diodes

Preliminary data

- For mixer applications in the VHF/UHF range
- For high speed switching

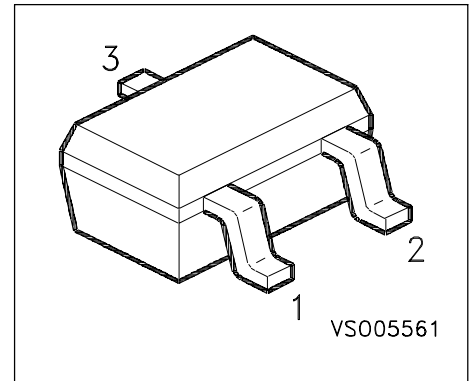

BAT 68-04W

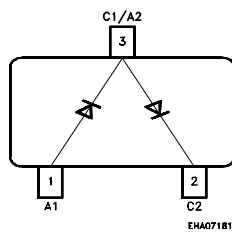

BAT68-05W

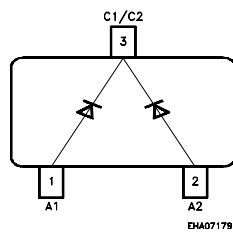

BAT68-06W

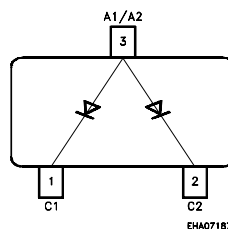

Type	Marking	Ordering Code	Pin Configuration			Package
BAT 68-04W	84s	Q62702-	1 = A1	2 = K2	3 = K1/A2	SOT-323
BAT 68-05W	85s	Q62702-	1 = A1	2 = A2	3 = K1/K2	SOT-323
BAT 68-06W	86s	Q62702-	1 = K1	2 = K2	3 = A1/A2	SOT-323
BAT 68W	83s	Q62702-	1 = A	n.c.	3 = K	SOT-323

Maximum Ratings

Parameter	Symbol	Values	Unit
Diode reverse voltage	V_R	8	V
Forward current	I_F	130	mA
Total power dissipation, BAT68W $T_S=97^\circ\text{C}$	P_{tot}	150	mW
Total power dissipation, BAW68-04...06W $T_S=92^\circ\text{C}$	P_{tot}	150	
Junction temperature	T_j	150	$^\circ\text{C}$
Operating temperature range	T_{op}	- 65 ... + 150	
Storage temperature	T_{stg}	- 65 ... + 150	

Thermal Resistance

Junction - ambient, BAT68W	R_{thJA}	≤ 435	K/W
Junction - ambient, BAT68-04W...06W	R_{thJA}	≤ 550	
Junctui - soldering point, BAT68W	R_{thJS}	≤ 355	
Junction - soldering point, BAT68-04W...06W	R_{thJS}	390	

Electrical Characteristics at $T_A=25^\circ\text{C}$, unless otherwise specified

Parameter	Symbol	Values			Unit
		min.	typ.	max.	
DC characteristics					
Breakdown voltage $I_{(BR)} = 100 \mu\text{A}$	$V_{(BR)}$	8	-	-	V
Reverse current $V_R = 1 \text{ V}, T_A = 25^\circ\text{C}$ $V_R = 1 \text{ V}, T_A = 60^\circ\text{C}$	I_R	-	-	0.1 1.2	μA
Forward voltage $I_F = 1 \text{ mA}$ $I_F = 10 \text{ mA}$	V_F	- 340	318 390	340 500	mV
Diode capacitance $V_R = 1 \text{ V}, f = 1 \text{ MHz}$	C_T	-	-	1	pF
Differential forward resistance $I_F = 5 \text{ mA}$	R_F	-	-	10	Ω

Forward current $I_F = f(T_A^*; T_S)$

*) : mounted on alumina 15mm x 16.7mm x 0.7mm
BAT 68W

Forward current $I_F = f(T_A^*; T_S)$

*) : mounted on alumina 15mm x 16.7mm x 0.7mm
BAT 68-04W, -05W, -06W

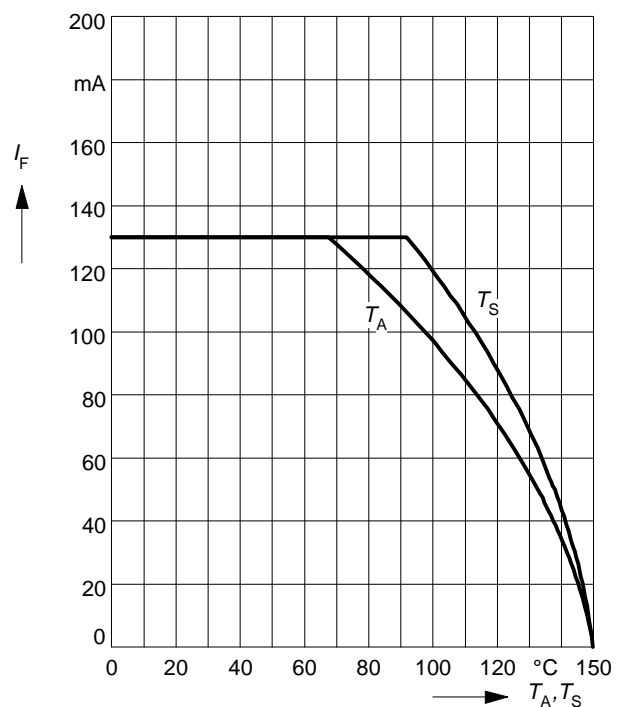
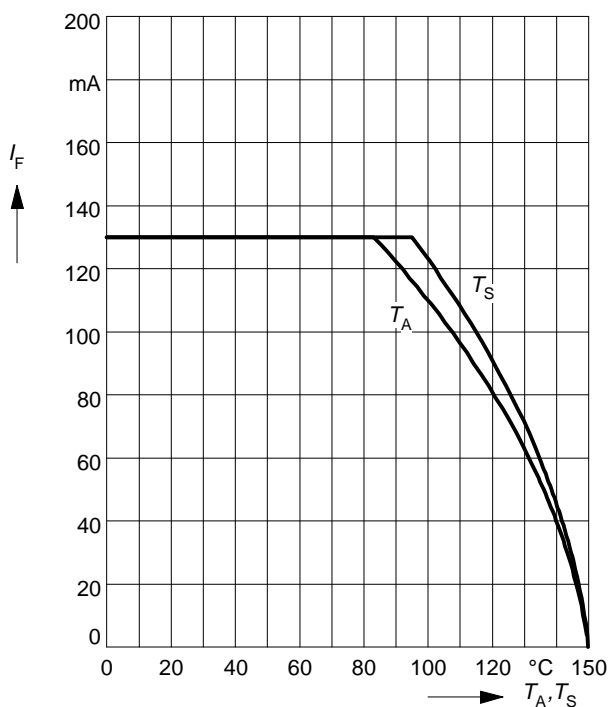

Permissible Pulse Load $R_{THJS} = f(t_p)$
BAT 68W

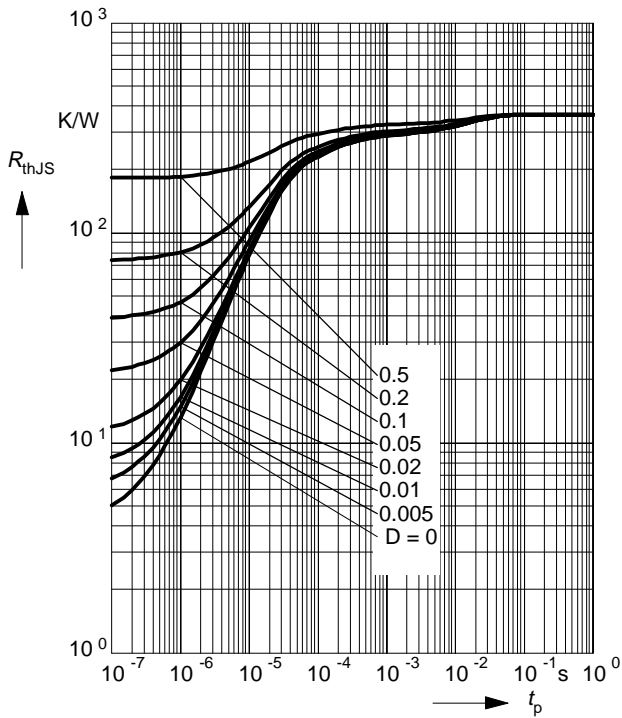

Permissible Pulse Load $I_{Fmax}/I_{FDC} = f(t_p)$
BAT 68W

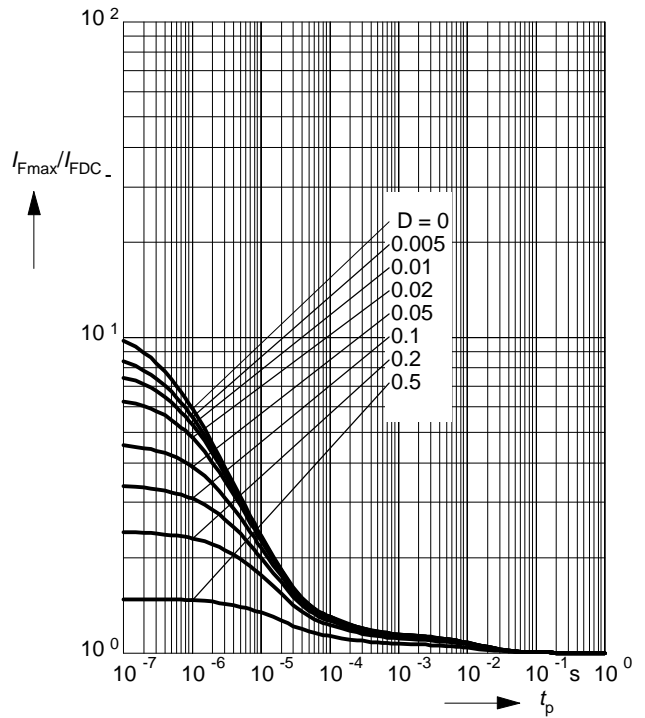

Permissible Pulse Load $R_{THJS} = f(t_p)$
BAT 68-04W, -05W, -06W

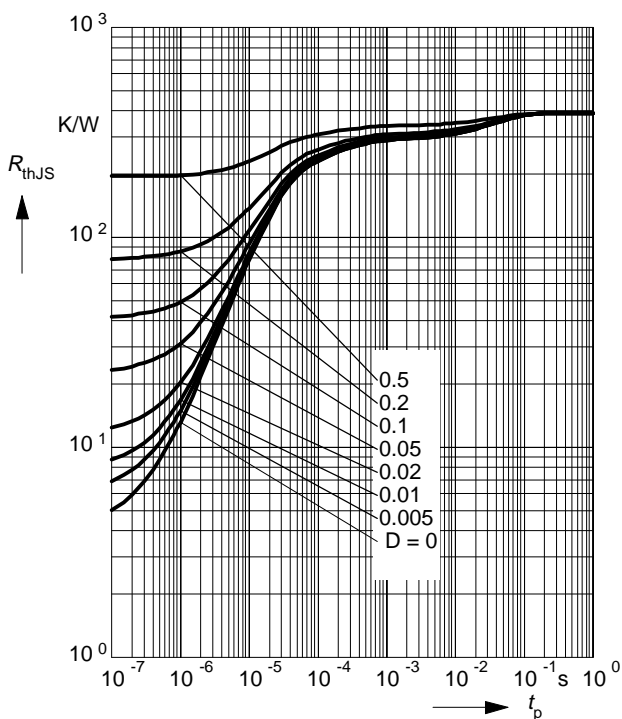

Permissible Pulse Load $I_{Fmax}/I_{FDC} = f(t_p)$
BAT 68-04W, -05W, -06W

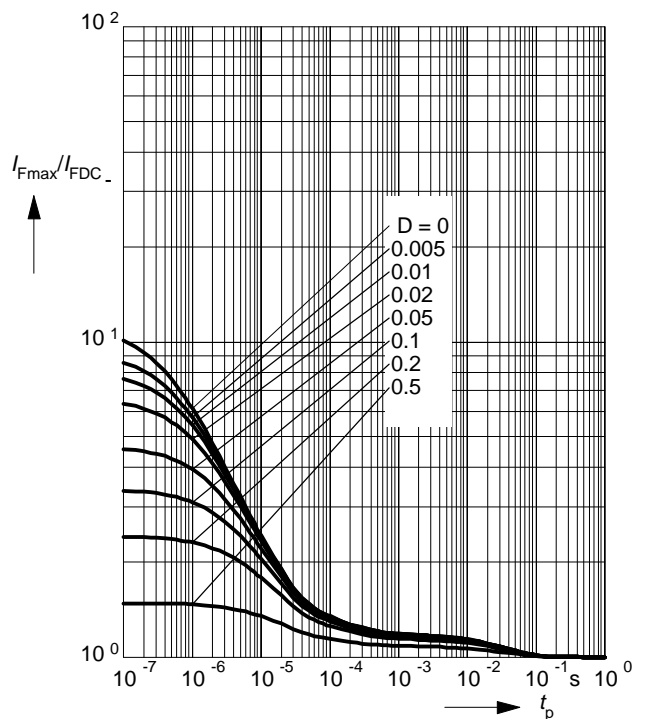

Diode capacitance $C_T = f(V_R)$
 $f = 1\text{MHz}$

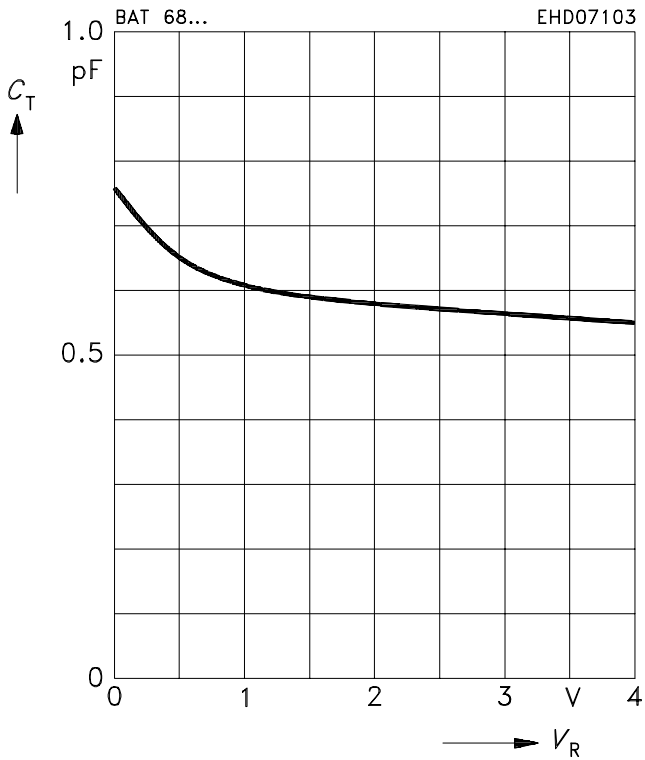

Forward Current $I_F = f(V_F)$

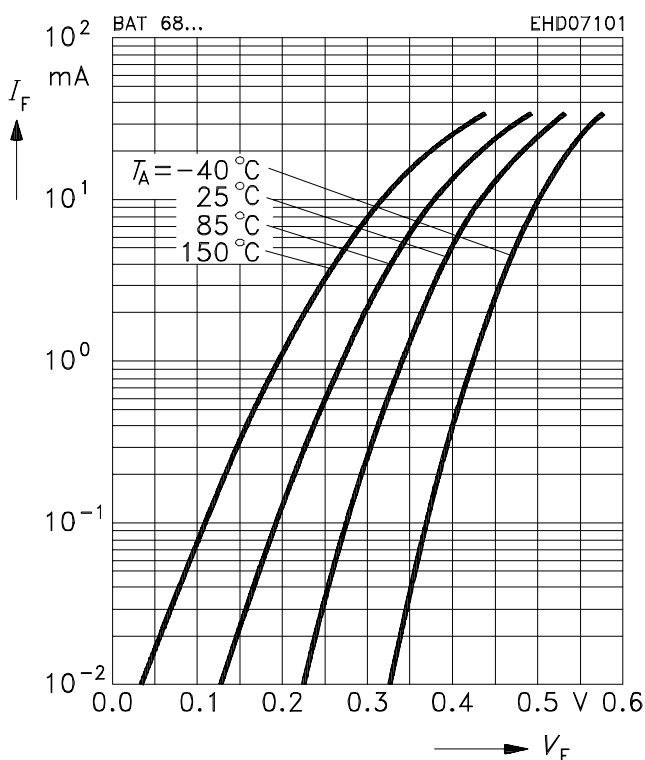

Differential forward resistance $r_f = f(I_F)$
 $f = 10\text{kHz}$

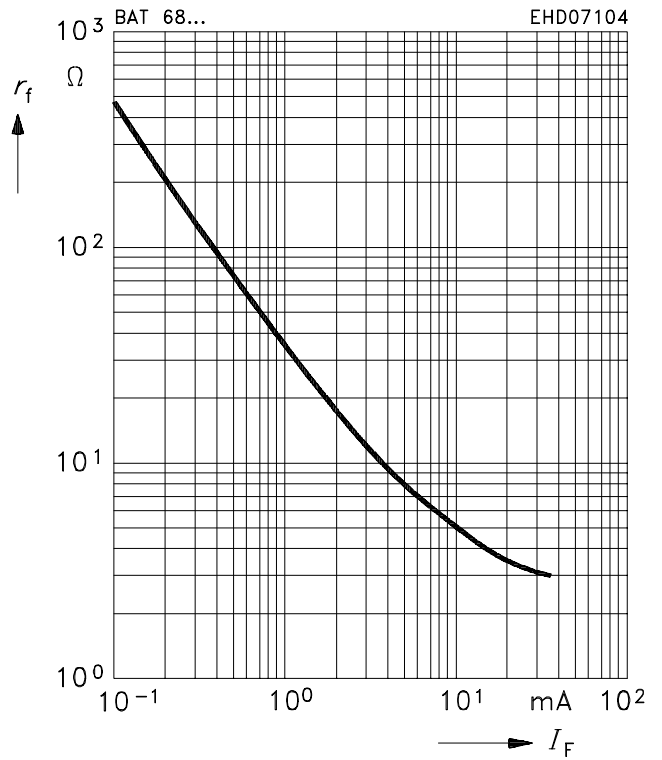

Reverse current $I_R = f(T_A)$
 $V_R = 28\text{V}$