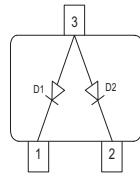
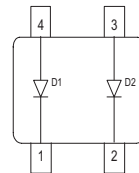
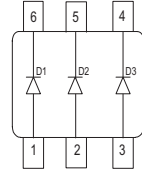

Silicon Schottky Diodes

- For mixer applications in the VHF / UHF range
- For high-speed switching applications
- Pb-free (RoHS compliant) package

BAT68

**BAT68-04
BAT68-04W**

**BAT68-06
BAT68-06W**

BAT68-07W

BAT68-08S

ESD (Electrostatic discharge) sensitive device, observe handling precaution!

Type	Package	Configuration	L_S (nH)	Marking
BAT68	SOT23	single	1.8	83s
BAT68-04	SOT23	series	1.8	84s
BAT68-04W	SOT323	series	1.4	84s
BAT68-06	SOT23	common anode	1.8	86s
BAT68-06W	SOT323	common anode	1.4	86s
BAT68-07W	SOT343	parallel pair	1.6	87s
BAT68-08S	SOT363	parallel triple	1.4	83s

Maximum Ratings at $T_A = 25^\circ\text{C}$, unless otherwise specified

Parameter	Symbol	Value	Unit
Diode reverse voltage	V_R	8	V
Forward current	I_F	130	mA
Total power dissipation BAT68, $T_S \leq 77^\circ\text{C}$ BAT68-04, BAT68-06, $T_S \leq 61^\circ\text{C}$ BAT68-04W/-06W/-08S, $T_S \leq 92^\circ\text{C}$ BAT68-07W, $T_S \leq 89^\circ\text{C}$	P_{tot}	150 150 150 150	mW
Junction temperature	T_j	150	°C
Storage temperature	T_{stg}	-55 ... 150	

Thermal Resistance

Parameter	Symbol	Value	Unit
Junction - soldering point ¹⁾ BAT68 BAT68-04, BAT68-06 BAT68-04W-BAT68-06W, BAT68-08S BAT68-07W	R_{thJS}	≤ 490 ≤ 590 ≤ 390 ≤ 410	K/W

Electrical Characteristics at $T_A = 25^\circ\text{C}$, unless otherwise specified

Parameter	Symbol	Values			Unit
		min.	typ.	max.	
Breakdown voltage $I_{(\text{BR})} = 10 \mu\text{A}$	$V_{(\text{BR})}$	8	-	-	V
Reverse current $V_R = 1 \text{ V}$ $V_R = 1 \text{ V}, T_A = 60^\circ\text{C}$	I_R	- -	- -	0.1 1.2	μA
Forward voltage $I_F = 1 \text{ mA}$ $I_F = 10 \text{ mA}$	V_F	- 340	318 390	340 500	mV

¹⁾For calculation of R_{thJA} please refer to Application Note Thermal Resistance

Electrical Characteristics at $T_A = 25^\circ\text{C}$, unless otherwise specified

Parameter	Symbol	Values			Unit
		min.	typ.	max.	
AC Characteristics					
Diode capacitance $V_R = 0, f = 1 \text{ MHz}$	C_T	-	-	1	pF
Differential forward resistance $I_F = 5 \text{ mA}, f = 10 \text{ kHz}$	R_F	-	-	10	Ω

Diode capacitance $C_T = f(V_R)$

$f = 1\text{MHz}$

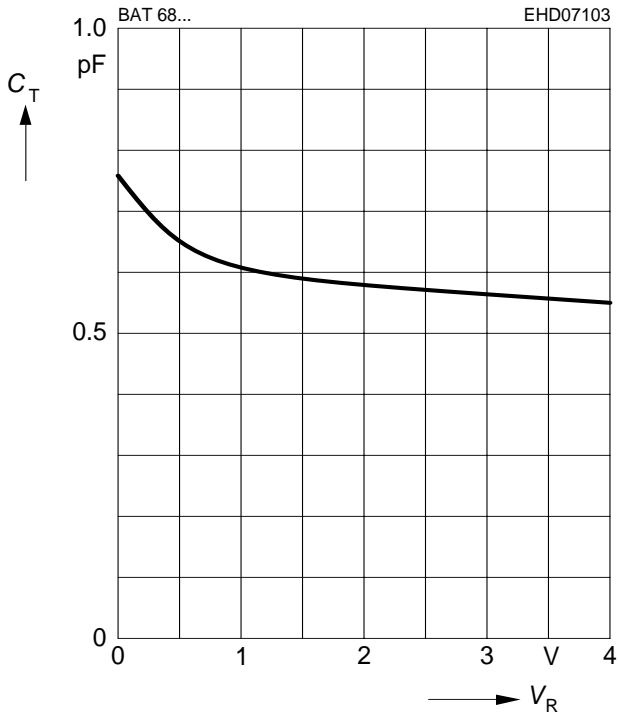

Differential forward resistance $r_f = f(I_F)$

$f = 10\text{kHz}$

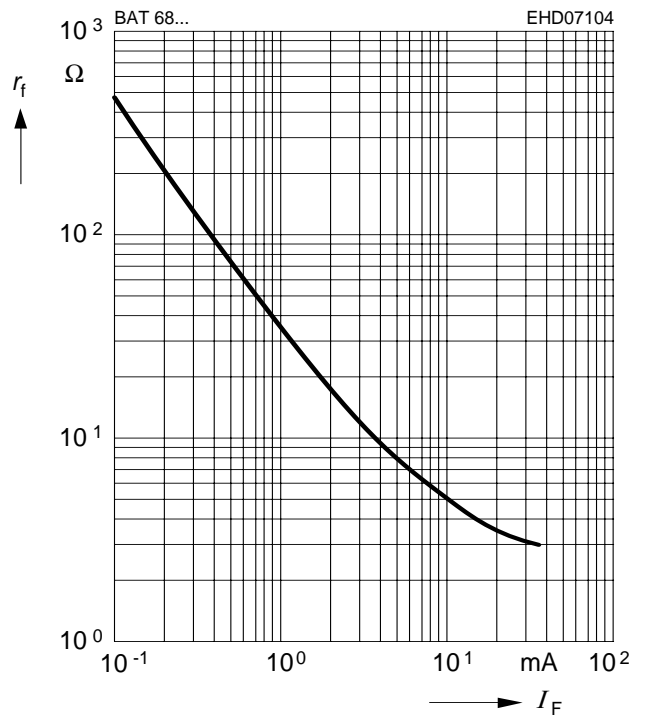

Reverse current $I_R = f(V_R)$

$T_A = \text{Parameter}$

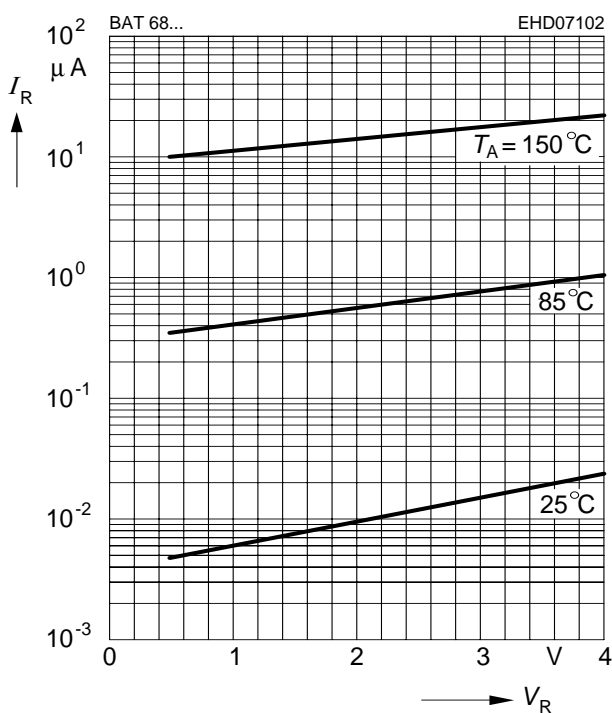

Forward current $I_F = f(V_F)$

$T_A = \text{Parameter}$

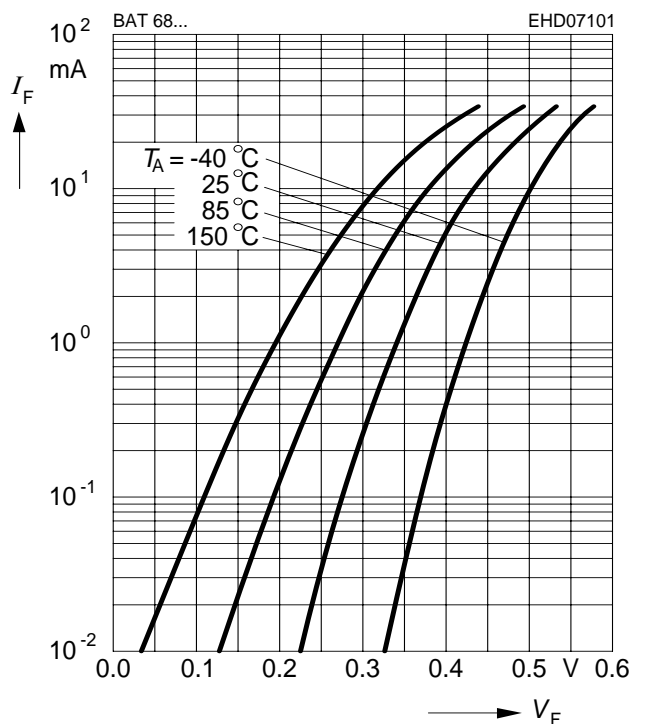

Forward current $I_F = f(T_S)$

BAT68

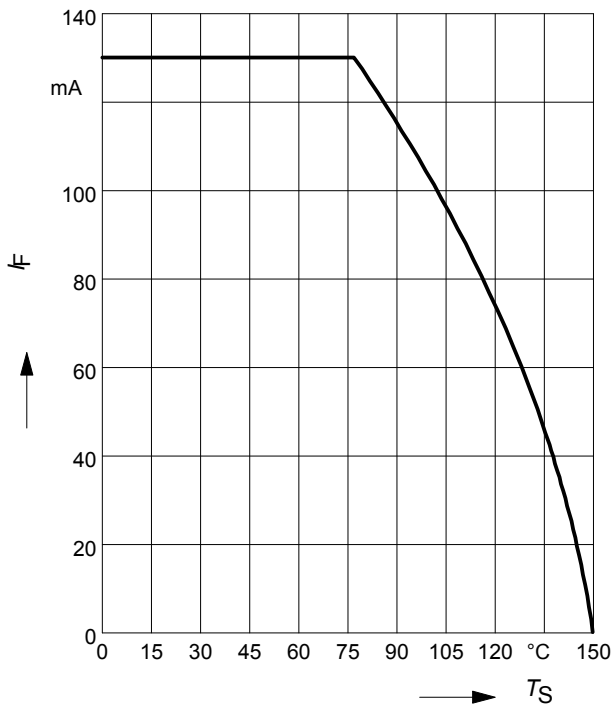

Forward current $I_F = f(T_S)$

BAT68-04, BAT68-06

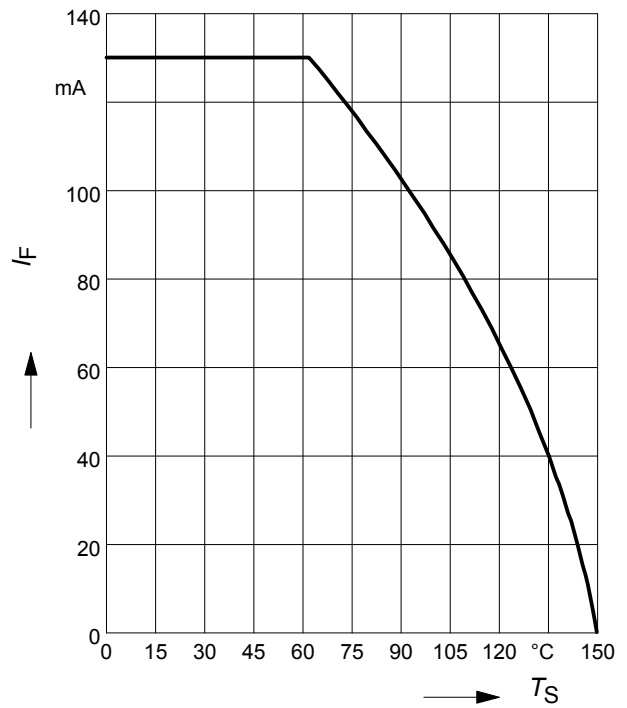

Forward current $I_F = f(T_S)$

BAT68-04W, BAT68-06W, BAT68-08S

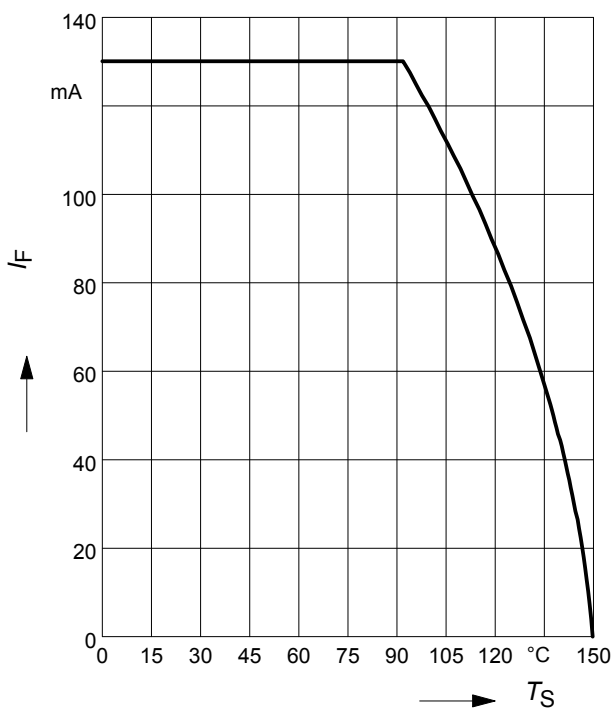

Forward current $I_F = f(T_S)$

BAT68-07W

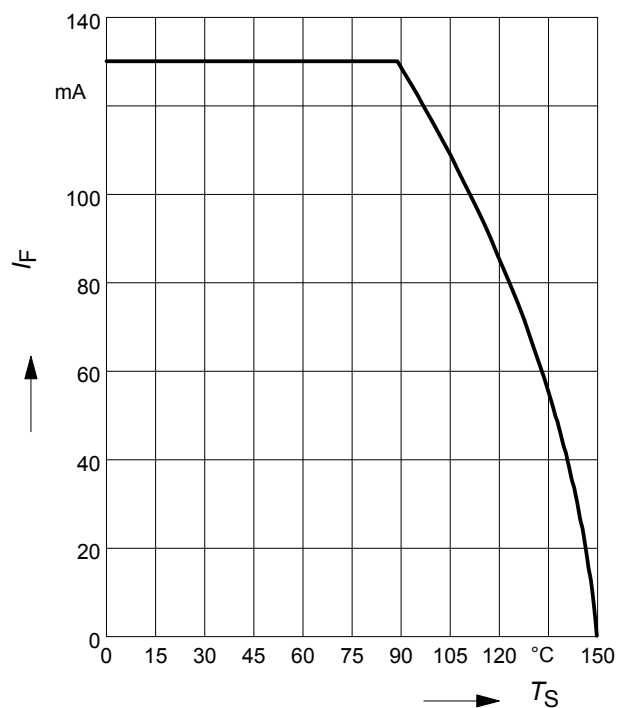

Permissible Puls Load $R_{thJS} = f(t_p)$

BAT68-04W, BAT68-06W

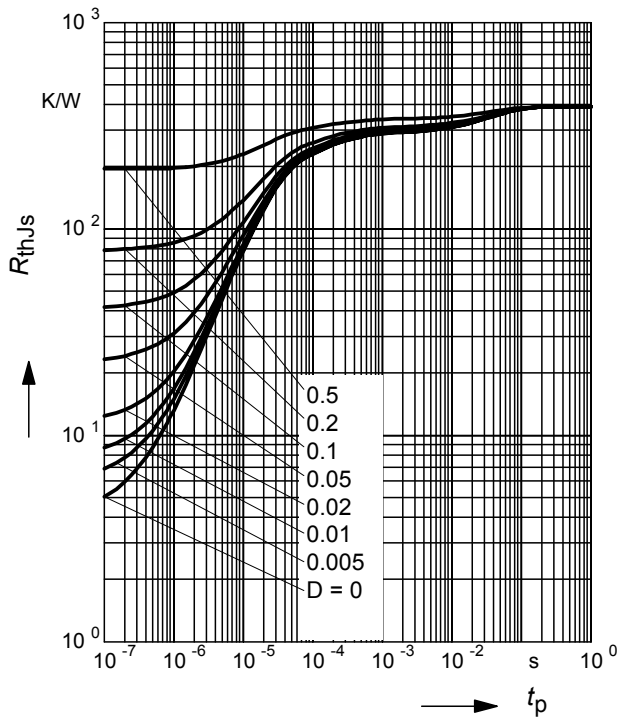

Permissible Pulse Load

$I_{Fmax} / I_{FDC} = f(t_p)$

BAT68-04W, BAT68-06W

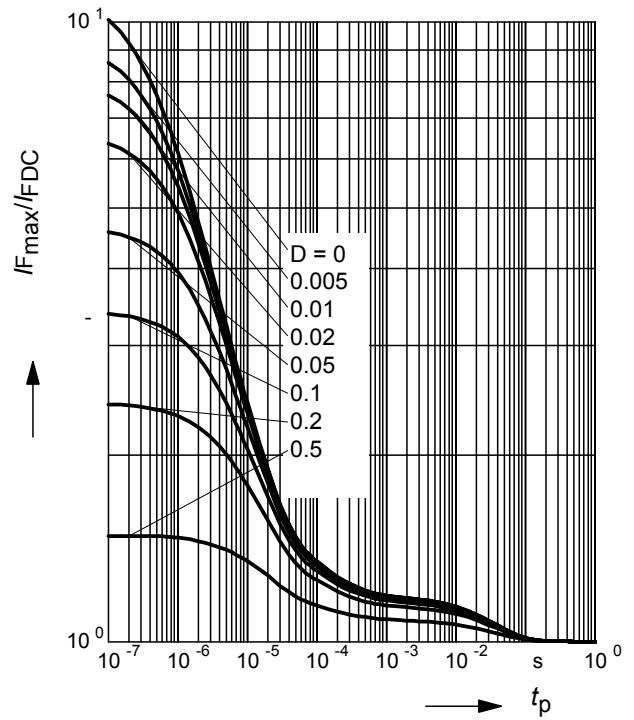

Permissible Puls Load $R_{thJS} = f(t_p)$

BAT68-07W

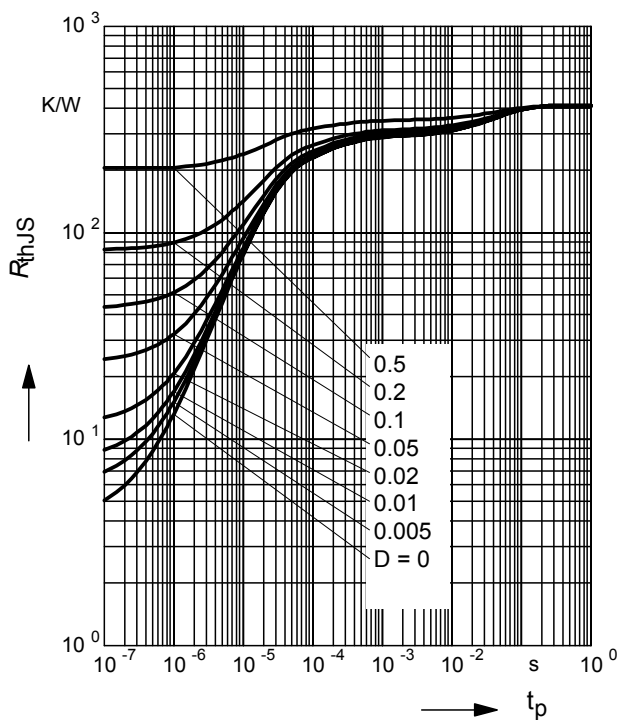

Permissible Pulse Load

$I_{Fmax} / I_{FDC} = f(t_p)$

BAT68-07W

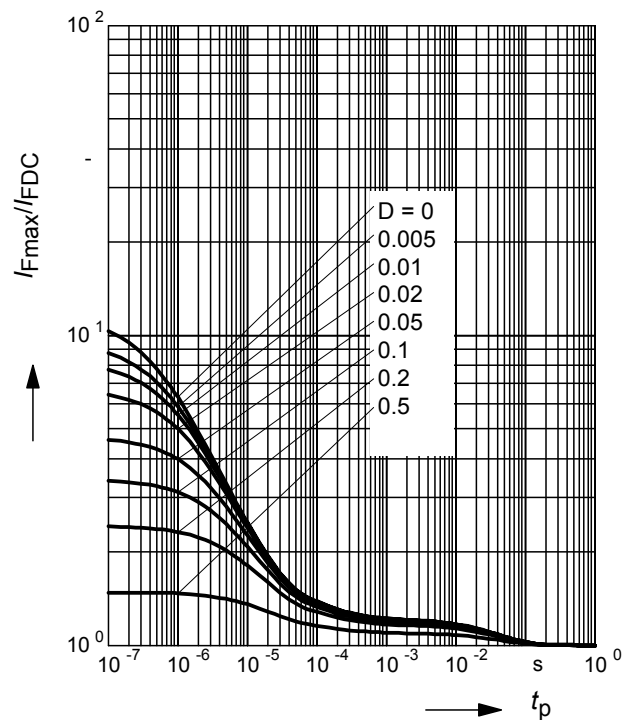

Rectifier voltage $V_{out} = f(V_{in})$

$f = 900\text{MHz}$

$R_L =$ Parameter in $k\Omega$

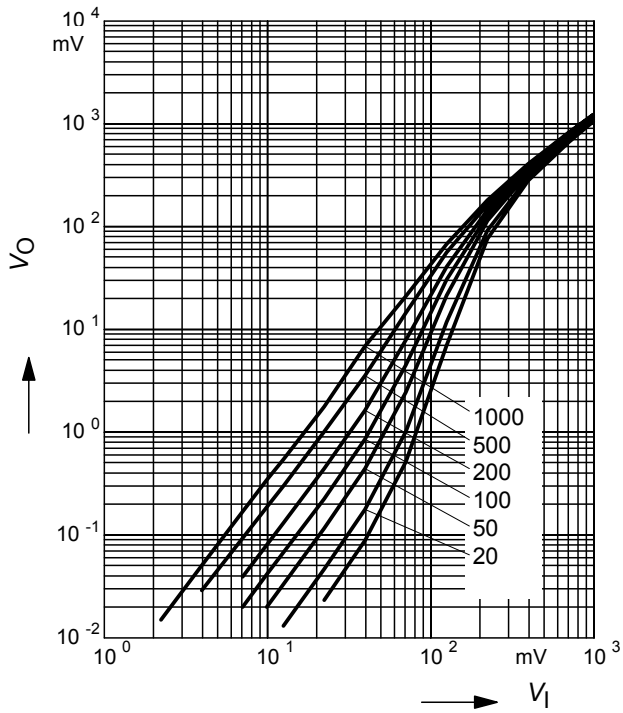

Testcircuit

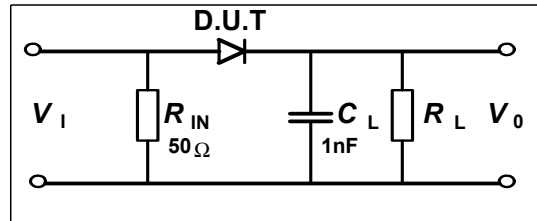

Package Outline



1) Lead width can be 0.6 max. in dambar area

Foot Print



Marking Layout (Example)



Standard Packing

Reel \varnothing 180 mm = 3.000 Pieces/Reel
 Reel \varnothing 330 mm = 10.000 Pieces/Reel



Package Outline



Foot Print



Marking Layout (Example)

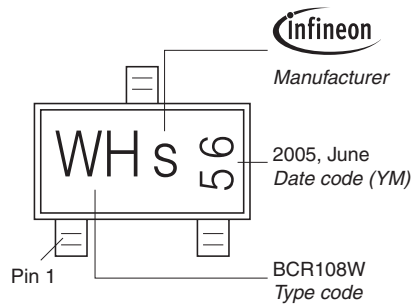

Standard Packing

Reel \varnothing 180 mm = 3.000 Pieces/Reel
 Reel \varnothing 330 mm = 10.000 Pieces/Reel

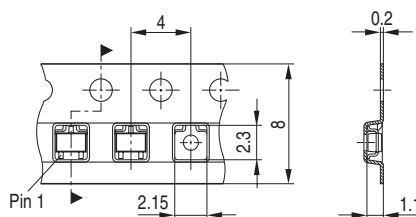

Package Outline

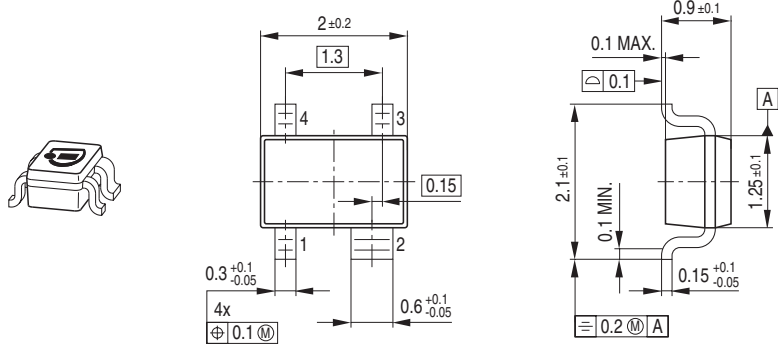

Foot Print

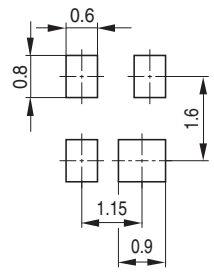

Marking Layout (Example)

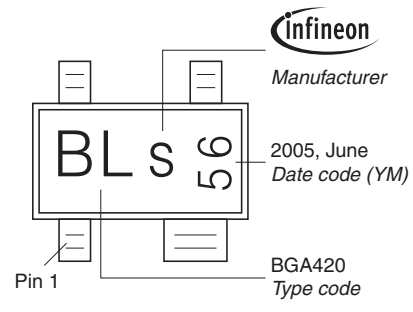

Standard Packing

Reel ø180 mm = 3.000 Pieces/Reel
 Reel ø330 mm = 10.000 Pieces/Reel

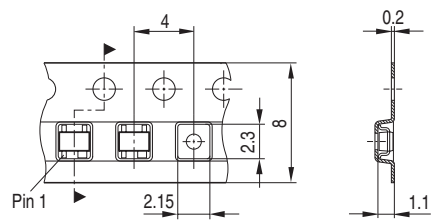

Package Outline

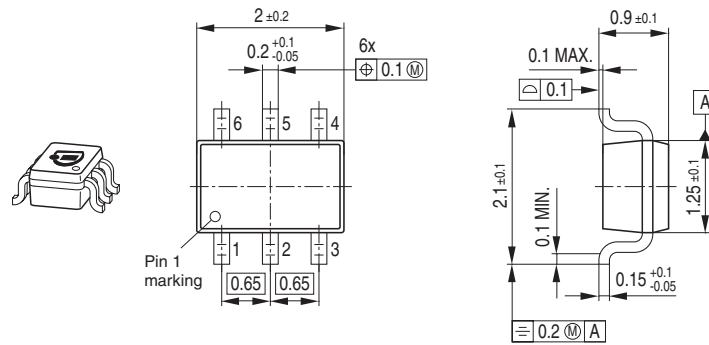

Foot Print

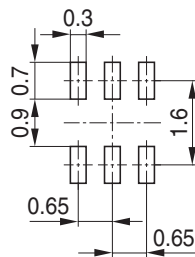

Marking Layout (Example)

Small variations in positioning of Date code, Type code and Manufacturer are possible.

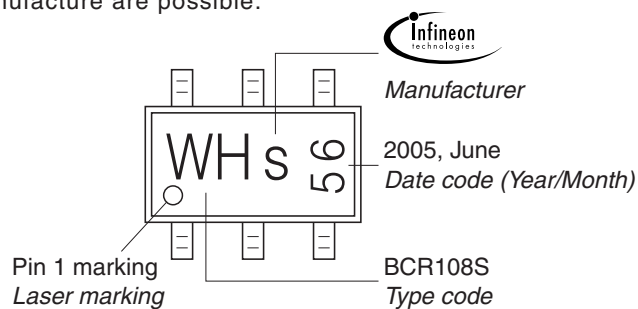

Standard Packing

Reel \varnothing 180 mm = 3.000 Pieces/Reel
 Reel \varnothing 330 mm = 10.000 Pieces/Reel

For symmetric types no defined Pin 1 orientation in reel.

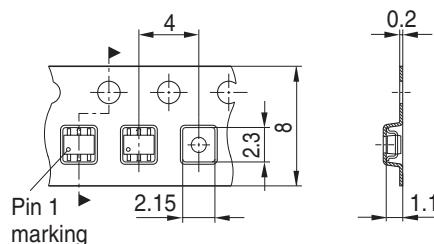

Edition 2009-11-16

**Published by
Infineon Technologies AG
81726 Munich, Germany**

**© 2009 Infineon Technologies AG
All Rights Reserved.**

Legal Disclaimer

The information given in this document shall in no event be regarded as a guarantee of conditions or characteristics. With respect to any examples or hints given herein, any typical values stated herein and/or any information regarding the application of the device, Infineon Technologies hereby disclaims any and all warranties and liabilities of any kind, including without limitation, warranties of non-infringement of intellectual property rights of any third party.

Information

For further information on technology, delivery terms and conditions and prices, please contact the nearest Infineon Technologies Office ([<www.infineon.com>](http://www.infineon.com)).

Warnings

Due to technical requirements, components may contain dangerous substances. For information on the types in question, please contact the nearest Infineon Technologies Office.

Infineon Technologies components may be used in life-support devices or systems only with the express written approval of Infineon Technologies, if a failure of such components can reasonably be expected to cause the failure of that life-support device or system or to affect the safety or effectiveness of that device or system. Life support devices or systems are intended to be implanted in the human body or to support and/or maintain and sustain and/or protect human life. If they fail, it is reasonable to assume that the health of the user or other persons may be endangered.