

Silicon Switching Diode Array

- For high-speed switching applications
- Common cathode

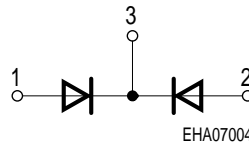
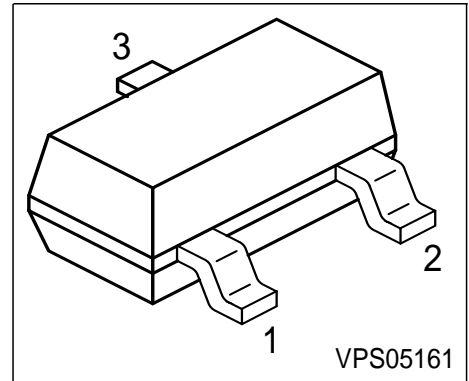

Type	Marking	Pin Configuration			Package
BAV74	JAs	1 = A1	2 = A2	3 = C1/2	SOT23

Maximum Ratings

Parameter	Symbol	Value	Unit
Diode reverse voltage	V_R	50	V
Peak reverse voltage	V_{RM}	50	
Forward current	I_F	200	mA
Surge forward current, $t = 1 \mu s$	I_{FS}	4.5	A
Total power dissipation, $T_S = 35 \text{ }^\circ\text{C}$	P_{tot}	250	mW
Junction temperature	T_j	150	$^\circ\text{C}$
Storage temperature	T_{stg}	-65 ... 150	

Thermal Resistance

Junction - soldering point ¹⁾	R_{thJS}	≤ 460	K/W
--	------------	------------	-----

¹⁾For calculation of R_{thJA} please refer to Application Note Thermal Resistance

Electrical Characteristics at $T_A = 25^\circ\text{C}$, unless otherwise specified.

Parameter	Symbol	Values			Unit
		min.	typ.	max.	
DC characteristics					
Breakdown voltage $I_{(BR)} = 100 \mu\text{A}$	$V_{(BR)}$	50	-	-	V
Forward voltage $I_F = 100 \text{ mA}$	V_F	-	-	1	
Reverse current $V_R = 50 \text{ V}$	I_R	-	-	0.1	μA
Reverse current $V_R = 50 \text{ V}, T_A = 150^\circ\text{C}$	I_R	-	-	100	
AC characteristics					
Diode capacitance $V_R = 0 \text{ V}, f = 1 \text{ MHz}$	C_D	-	-	2	pF
Reverse recovery time $I_F = 10 \text{ mA}, I_R = 10 \text{ mA}, R_L = 100 \Omega$, measured at $I_R = 1 \text{ mA}$	t_{rr}	-	-	4	ns

Test circuit for reverse recovery time

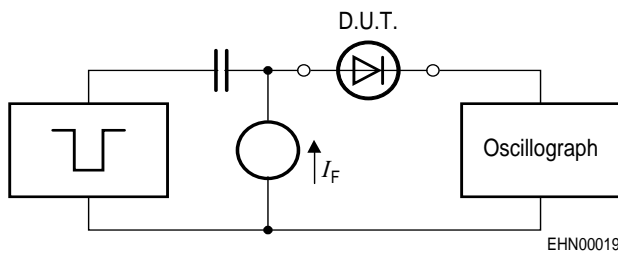

Pulse generator: $t_p = 100\text{ns}$, $D = 0.05$,
 $t_f = 0.6\text{ns}$, $R_f = 50\Omega$

Oscilloscope: $R = 50\Omega$, $t_f = 0.35\text{ns}$,
 $C \leq 1\text{pF}$

Forward current $I_F = f(T_S)$

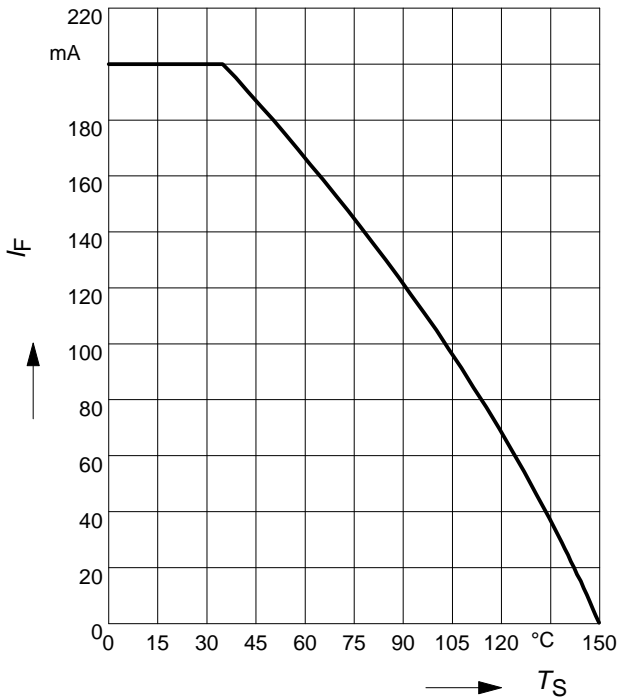

Reverse current $I_R = f(T_A)$

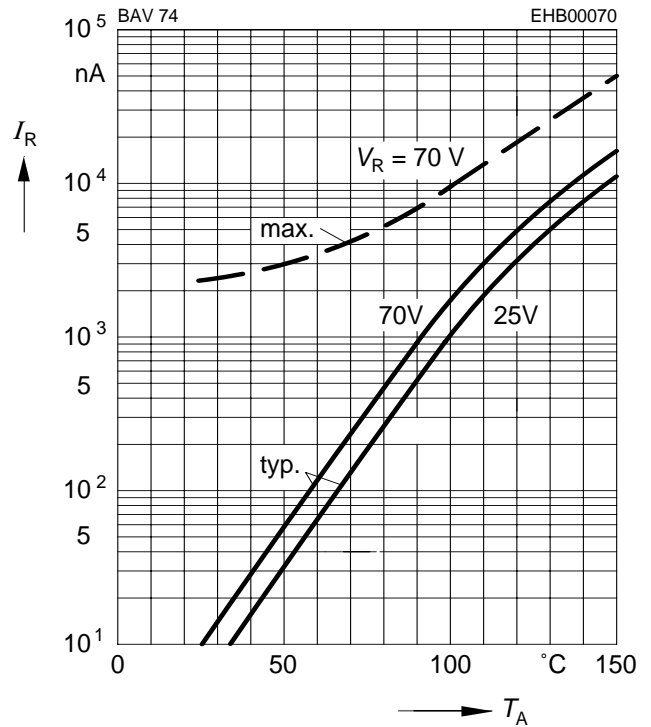

Forward current $I_F = f(V_F)$

$T_A = 25^\circ\text{C}$

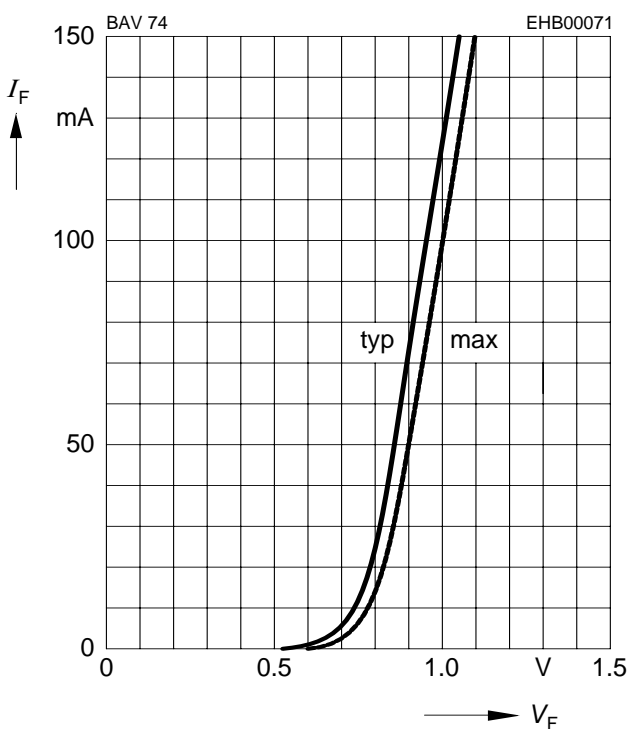

Peak forward current $I_{FM} = f(t_p)$

$T_A = 25^\circ\text{C}$

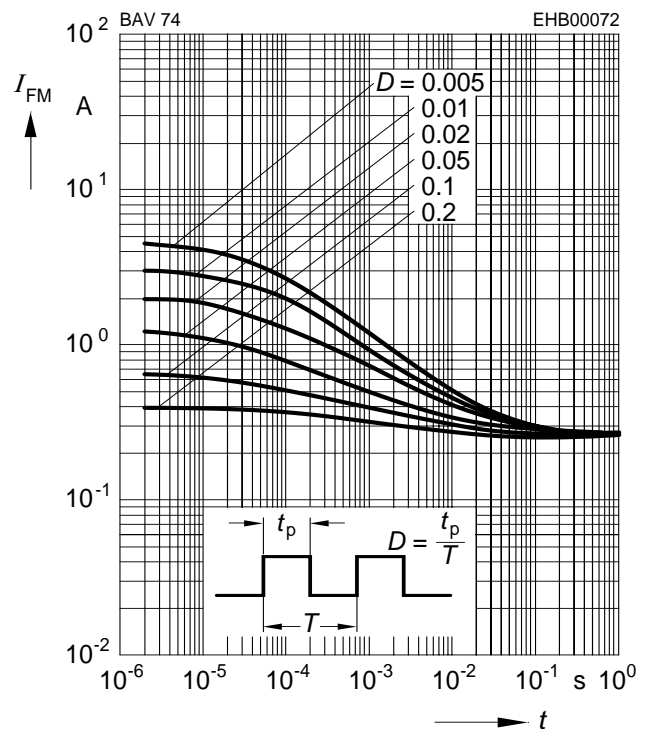

Forward voltage $V_F = f(T_A)$

