

SOT-363 Plastic-Encapsulate Diodes

BAV99BDW

HIGH-SPEED SWITCHING DIODE

FEATURES

- Small Plastic Package
- Ultra High Speed Switching

APPLICATION

- For General Purpose Switching Application

MARKING: DN

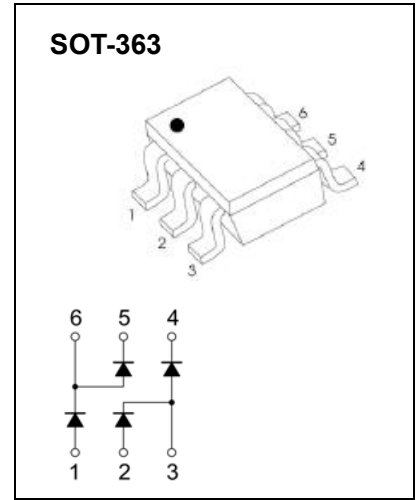

MAXIMUM RATINGS ($T_a=25^{\circ}\text{C}$ unless otherwise noted)

| Symbol | Parameter | Value | Unit |
|-----------------|--|----------|-----------------------------|
| V_{RM} | Non-Repetitive Peak Reverse Voltage | 100 | V |
| V_{RRM} | Peak Repetitive Reverse Voltage | 75 | V |
| V_{RWM} | Working Peak Reverse Voltage | | |
| $V_{R(RMS)}$ | RMS Reverse Voltage | 53 | V |
| I_O | Average Rectified Output Current | 215 | mA |
| I_{FSM} | Non-Repetitive Peak Forward Surge Current @ $t=8.3\text{ms}$ | 2 | A |
| P_D | Power Dissipation | 200 | mW |
| $R_{\theta JA}$ | Thermal Resistance from Junction to Ambient | 625 | $^{\circ}\text{C}/\text{W}$ |
| T_j | Junction Temperature | 150 | $^{\circ}\text{C}$ |
| T_{stg} | Storage Temperature | -55~+150 | $^{\circ}\text{C}$ |

ELECTRICAL CHARACTERISTICS($T_a=25^{\circ}\text{C}$ unless otherwise specified)

| Parameter | Symbol | Test conditions | Min | Typ | Max | Unit |
|-----------------------|------------|---|-----|-----|-------|---------------|
| Reverse voltage | $V_{(BR)}$ | $I_R=100\mu\text{A}$ | 75 | | | V |
| Reverse current | I_R | $V_R=75\text{V}$ | | | 2.5 | μA |
| | | $V_R=20\text{V}$ | | | 25 | nA |
| Forward voltage | V_F | $I_F=1\text{mA}$ | | | 0.715 | V |
| | | $I_F=10\text{mA}$ | | | 0.855 | |
| | | $I_F=50\text{mA}$ | | | 1 | |
| | | $I_F=150\text{mA}$ | | | 1.25 | |
| Total capacitance | C_{tot} | $V_R=0, f=1\text{MHz}$ | | | 2 | pF |
| Reverse recovery time | t_{rr} | $I_F=I_R=10\text{mA}, I_{rr}=0.1 \times I_R, R_L=100\Omega$ | | | 4 | ns |

Typical Characteristics

Forward Characteristics

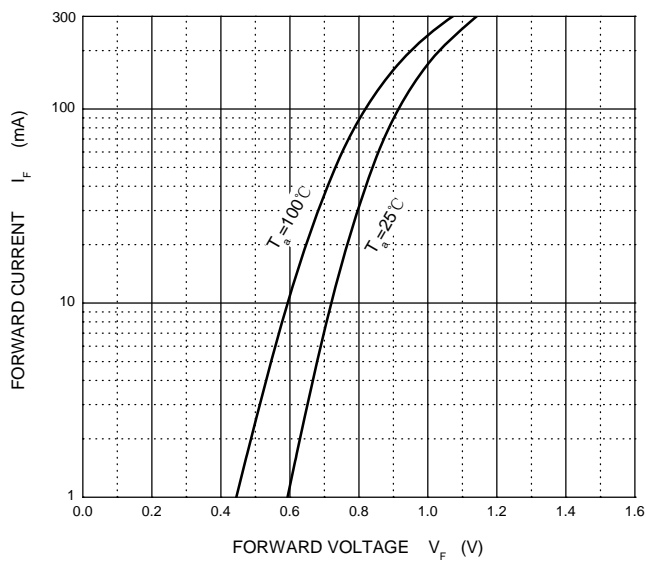

Reverse Characteristics

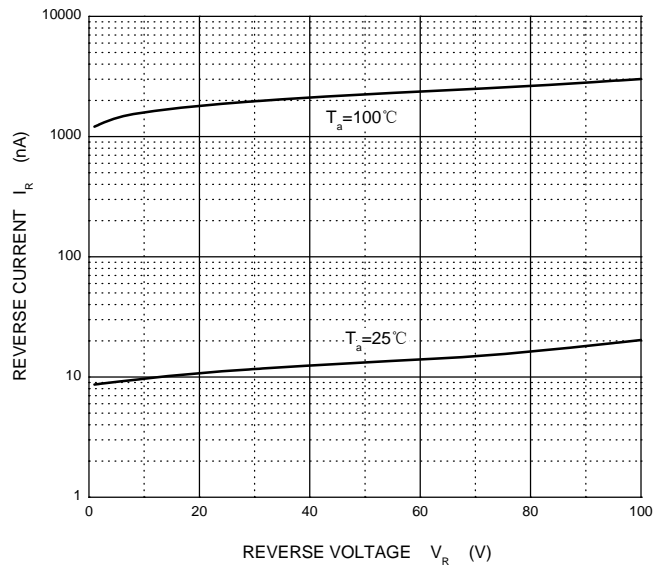

Capacitance Characteristics

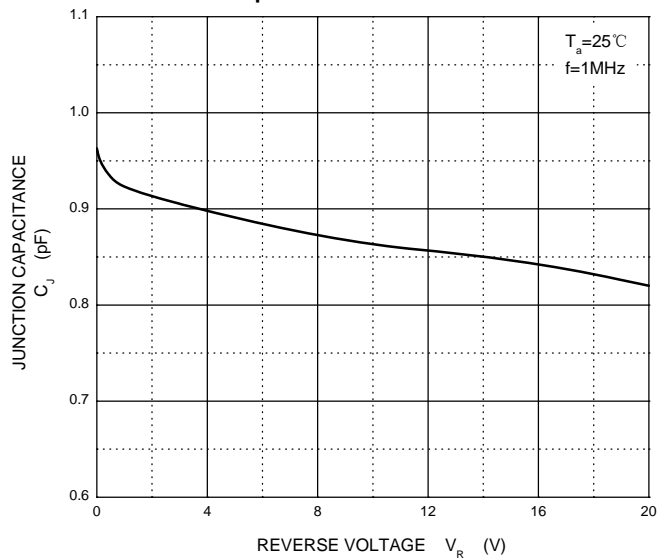

Power Derating Curve

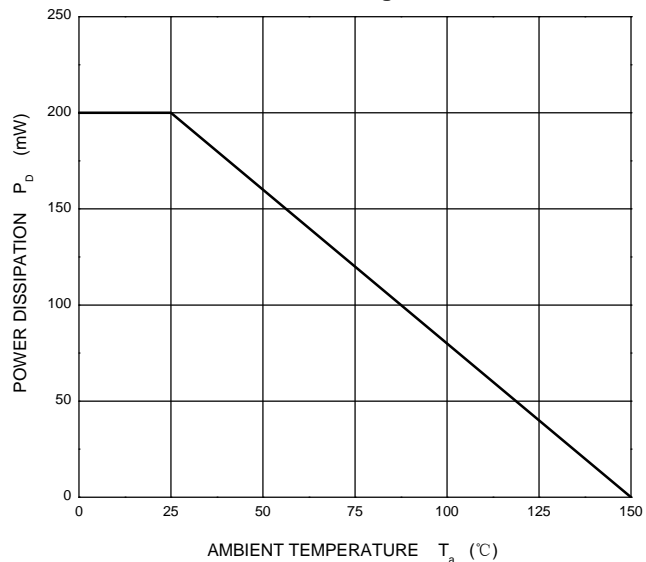

SOT-363 Package Outline Dimensions

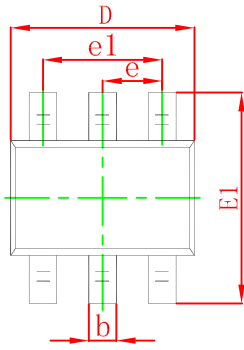

| Symbol | Dimensions In Millimeters | | Dimensions In Inches | |
|--------|---------------------------|-------|----------------------|-------|
| | Min | Max | Min | Max |
| A | 0.900 | 1.100 | 0.035 | 0.043 |
| A1 | 0.000 | 0.100 | 0.000 | 0.004 |
| A2 | 0.900 | 1.000 | 0.035 | 0.039 |
| b | 0.150 | 0.350 | 0.006 | 0.014 |
| c | 0.100 | 0.150 | 0.004 | 0.006 |
| D | 2.000 | 2.200 | 0.079 | 0.087 |
| E | 1.150 | 1.350 | 0.045 | 0.053 |
| E1 | 2.150 | 2.400 | 0.085 | 0.094 |
| e | 0.650 TYP | | 0.026 TYP | |
| e1 | 1.200 | 1.400 | 0.047 | 0.055 |
| L | 0.525 REF | | 0.021 REF | |
| L1 | 0.260 | 0.460 | 0.010 | 0.018 |
| theta | 0° | 8° | 0° | 8° |

SOT-363 Suggested Pad Layout



Note:

1. Controlling dimension: in millimeters.
2. General tolerance: $\pm 0.05\text{mm}$.
3. The pad layout is for reference purposes only.

NOTICE

JCET reserve the right to make modifications, enhancements, improvements, corrections or other changes without further notice to any product herein. JCET does not assume any liability arising out of the application or use of any product described herein.

SOT-363 Tape and Reel

SOT-363 Embossed Carrier Tape

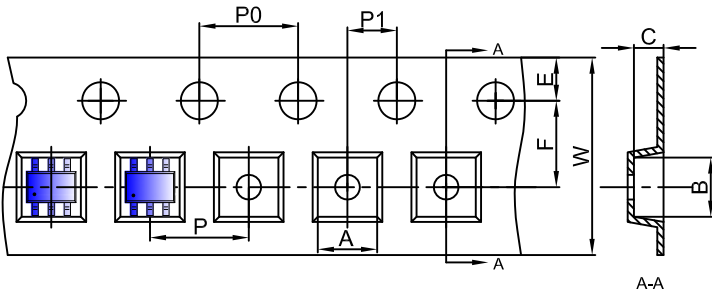

Packaging Description:

SOT-363 parts are shipped in tape. The carrier tape is made from a dissipative (carbon filled) polycarbonate resin. The cover tape is a multilayer film (Heat Activated Adhesive in nature) primarily composed of polyester film, adhesive layer, sealant, and anti-static sprayed agent. These reeled parts in standard option are shipped with 3,000 units per 7" or 17.8cm diameter reel. The reels are clear in color and is made of polystyrene plastic (anti-static coated).

| Dimensions are in millimeter | | | | | | | | | | |
|------------------------------|------|------|------|-------|------|------|------|------|------|------|
| Pkg type | A | B | C | d | E | F | P0 | P | P1 | W |
| SOT-363 | 2.25 | 2.55 | 1.20 | Ø1.50 | 1.75 | 3.50 | 4.00 | 4.00 | 2.00 | 8.00 |

SOT-363 Tape Leader and Trailer

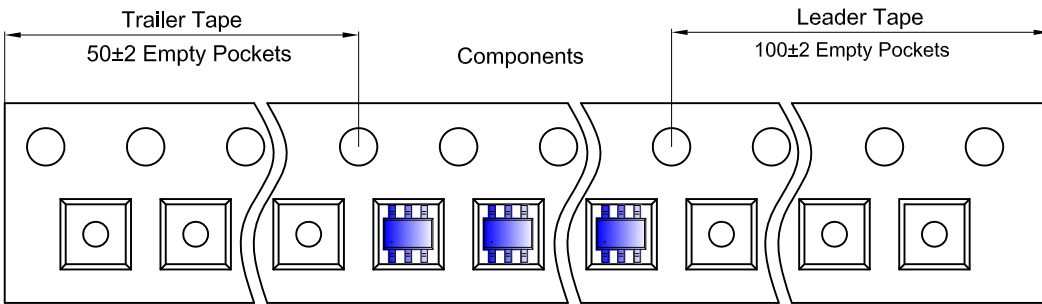

SOT-363 Reel

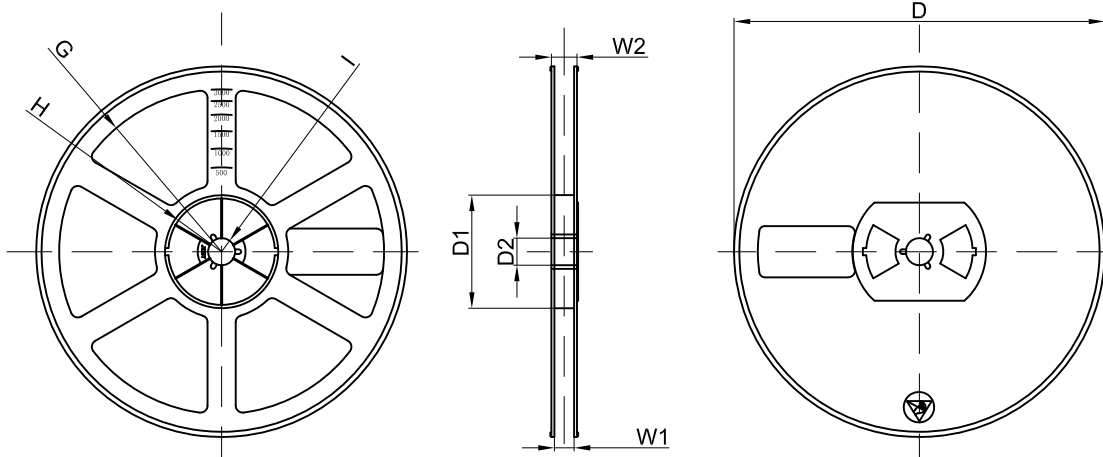

| Dimensions are in millimeter | | | | | | | | |
|------------------------------|---------|-------|-------|--------|--------|-------|------|-------|
| Reel Option | D | D1 | D2 | G | H | I | W1 | W2 |
| 7"Dia | Ø178.00 | 54.40 | 13.00 | R78.00 | R25.60 | R6.50 | 9.50 | 12.30 |

| REEL | Reel Size | Box | Box Size(mm) | Carton | Carton Size(mm) | G.W.(kg) |
|----------|-----------|------------|--------------|-------------|-----------------|----------|
| 3000 pcs | 7 inch | 45,000 pcs | 203×203×195 | 180,000 pcs | 438×438×220 | |