

## SOT-363 Plastic-Encapsulate Diodes

### BAV99S

HIGH-SPEED SWITCHING DIODE

#### FEATURES

- Small Plastic Package
- High Switching Speed
- Low Capacitance
- Two Electrically Isolated Series Configuration Arrays

#### MARKING: K1



Solid dot = Pin1 indicate.

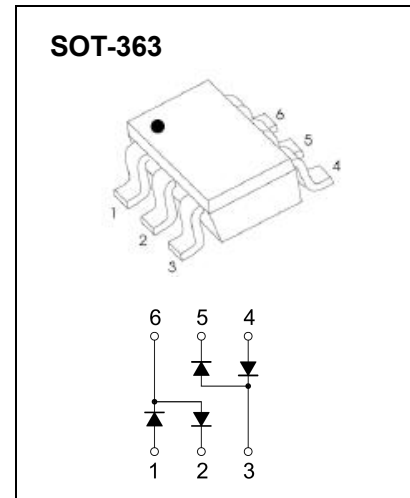

#### MAXIMUM RATINGS @ ( $T_a=25^\circ\text{C}$ unless otherwise noted )

| Symbol          | Parameter  | Limits   | Unit                      |
|-----------------|--|----------|---------------------------|
| $V_{RRM}$       | Repetitive Peak Reverse Voltage                              | 85       | V                         |
| $V_R$           | Reverse Voltage  | 75       | V                         |
| $I_F$           | Forward Current  | 150      | mA                        |
| $I_{FRM}$       | Repetitive Peak Forward Current                              | 450      |                           |
| $I_{FSM}$       | Non-Repetitive Peak Forward Surge Current @ $t=8.3\text{ms}$ | 2.5      | A                         |
| $P_D$           | Power Dissipation  | 200      | mW                        |
| $R_{\theta JA}$ | Thermal Resistance from Junction to Ambient                  | 625      | $^\circ\text{C}/\text{W}$ |
| $T_j$           | Junction Temperature   | 150      | $^\circ\text{C}$          |
| $T_{stg}$       | Storage Temperature  | -55~+150 |                           |

#### ELECTRICAL CHARACTERISTICS ( $T_a=25^\circ\text{C}$ unless otherwise specified)

| Parameter             | Symbol     | Test conditions   | Min | Typ | Max   | Unit          |
|-----------------------|------------|---|-----|-----|-------|---------------|
| Reverse voltage       | $V_{(BR)}$ | $I_R=100\mu\text{A}$  | 75  |     |       | V             |
| Reverse current       | $I_R$      | $V_R=75\text{V}$  |     |     | 1     | $\mu\text{A}$ |
| Forward voltage       | $V_F$      | $I_F=1\text{mA}$  |     |     | 0.715 | V             |
|                       |            | $I_F=10\text{mA}$   |     |     | 0.855 |               |
|                       |            | $I_F=50\text{mA}$   |     |     | 1     |               |
|                       |            | $I_F=150\text{mA}$  |     |     | 1.25  |               |
| Total capacitance     | $C_{tot}$  | $V_R=0, f=1\text{MHz}$                                      |     |     | 1.5   | pF            |
| Reverse recovery time | $t_{rr}$   | $I_F=I_R=10\text{mA}, I_{rr}=0.1 \times I_R, R_L=100\Omega$ |     |     | 6     | ns            |

# Typical Characteristics

**Forward Characteristics**

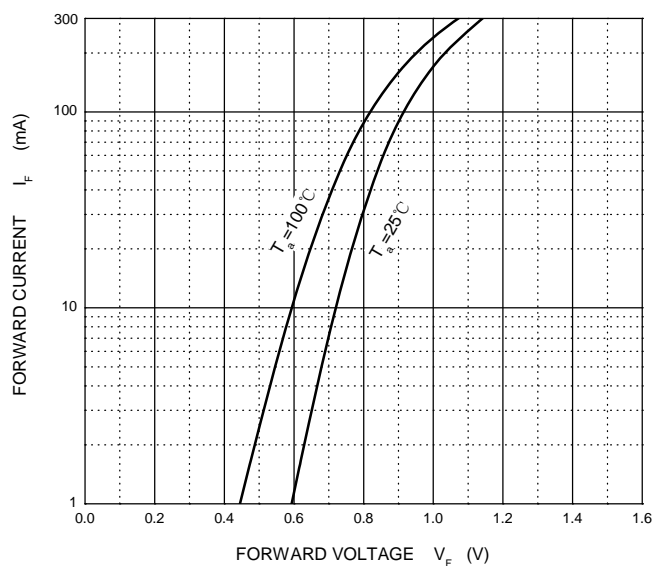

**Reverse Characteristics**

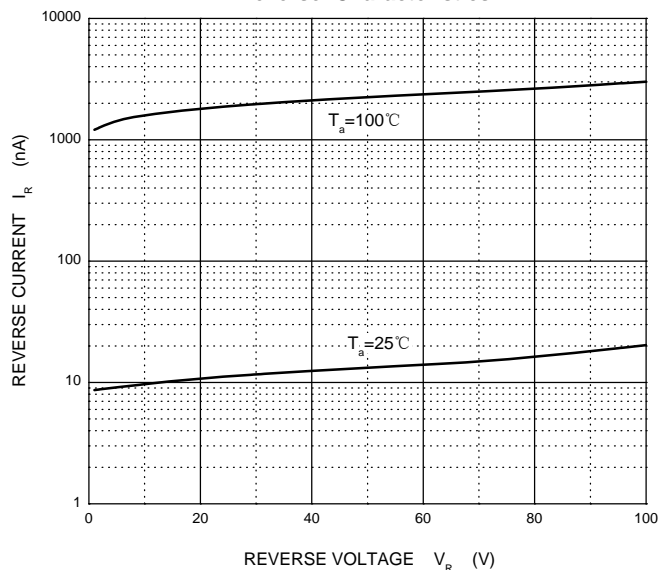

**Capacitance Characteristics**

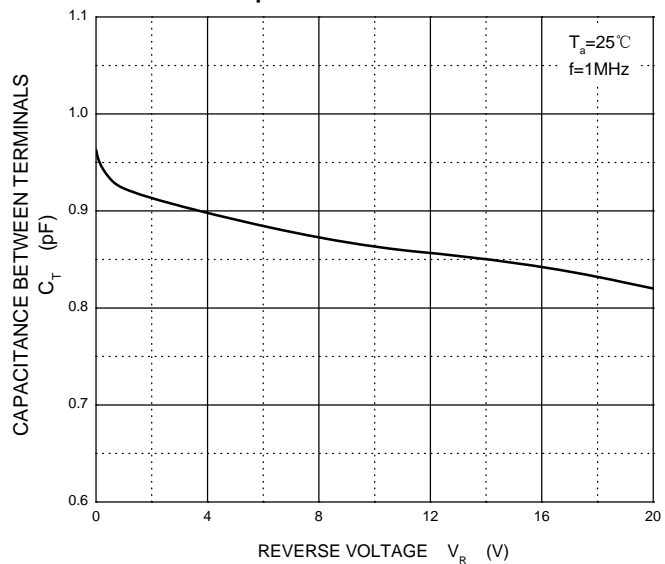

**Power Derating Curve**

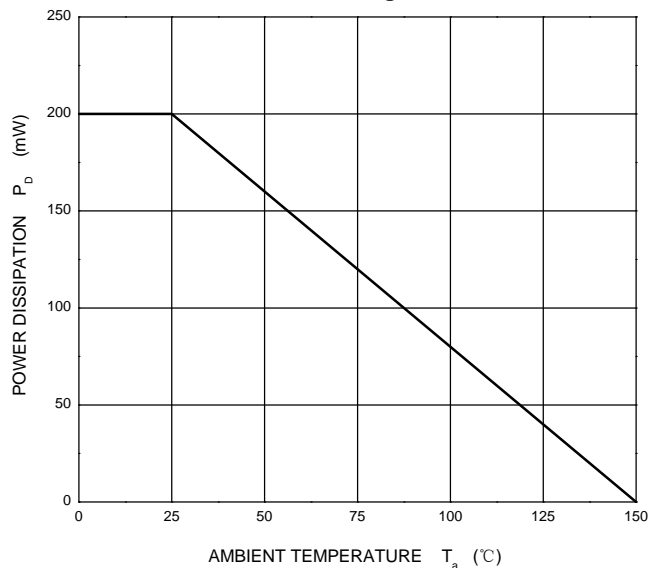

## SOT-363 Package Outline Dimensions

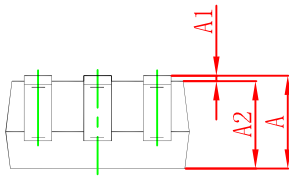
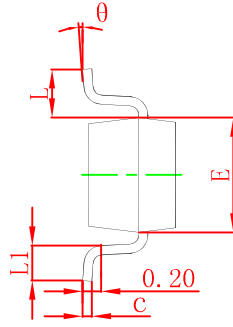
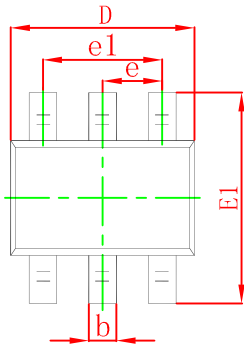

| Symbol   | Dimensions In Millimeters |       | Dimensions In Inches |       |
|----------|---------------------------|-------|----------------------|-------|
|          | Min                       | Max   | Min                  | Max   |
| A        | 0.900                     | 1.100 | 0.035                | 0.043 |
| A1       | 0.000                     | 0.100 | 0.000                | 0.004 |
| A2       | 0.900                     | 1.000 | 0.035                | 0.039 |
| b        | 0.150                     | 0.350 | 0.006                | 0.014 |
| c        | 0.100                     | 0.150 | 0.004                | 0.006 |
| D        | 2.000                     | 2.200 | 0.079                | 0.087 |
| E        | 1.150                     | 1.350 | 0.045                | 0.053 |
| E1       | 2.150                     | 2.400 | 0.085                | 0.094 |
| e        | 0.650 TYP                 |       | 0.026 TYP            |       |
| e1       | 1.200                     | 1.400 | 0.047                | 0.055 |
| L        | 0.525 REF                 |       | 0.021 REF            |       |
| L1       | 0.260                     | 0.460 | 0.010                | 0.018 |
| $\theta$ | 0°                        | 8°    | 0°                   | 8°    |

## SOT-363 Suggested Pad Layout

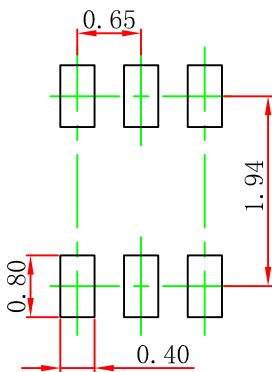

### Note:

1. Controlling dimension: in millimeters.
2. General tolerance:  $\pm 0.05\text{mm}$ .
3. The pad layout is for reference purposes only.

## NOTICE

JCET reserve the right to make modifications, enhancements, improvements, corrections or other changes without further notice to any product herein. JCET does not assume any liability arising out of the application or use of any product described herein.

# SOT-363 Tape and Reel

## SOT-363 Embossed Carrier Tape

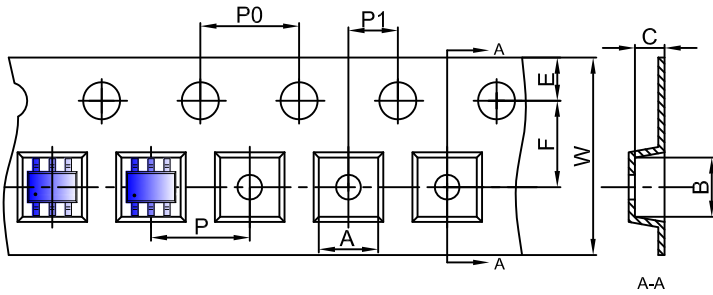

### Packaging Description:

SOT-363 parts are shipped in tape. The carrier tape is made from a dissipative (carbon filled) polycarbonate resin. The cover tape is a multilayer film (Heat Activated Adhesive in nature) primarily composed of polyester film, adhesive layer, sealant, and anti-static sprayed agent. These reeled parts in standard option are shipped with 3,000 units per 7" or 17.8cm diameter reel. The reels are clear in color and is made of polystyrene plastic (anti-static coated).

| Dimensions are in millimeter |      |      |      |       |      |      |      |      |      |      |
|------------------------------|------|------|------|-------|------|------|------|------|------|------|
| Pkg type                     | A    | B    | C    | d     | E    | F    | P0   | P    | P1   | W    |
| SOT-363                      | 2.25 | 2.55 | 1.20 | Ø1.50 | 1.75 | 3.50 | 4.00 | 4.00 | 2.00 | 8.00 |

## SOT-363 Tape Leader and Trailer

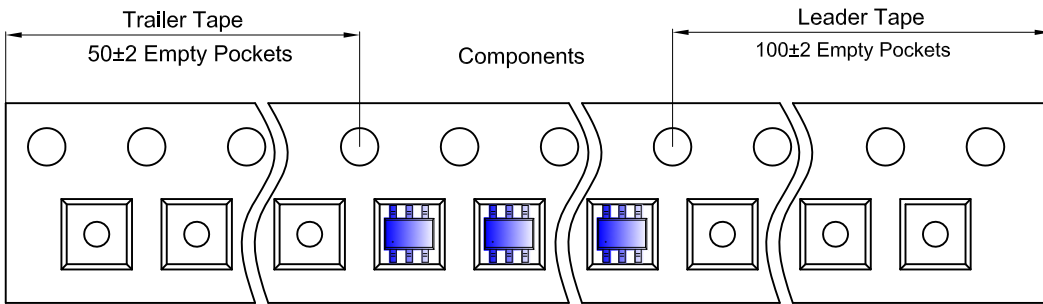

## SOT-363 Reel

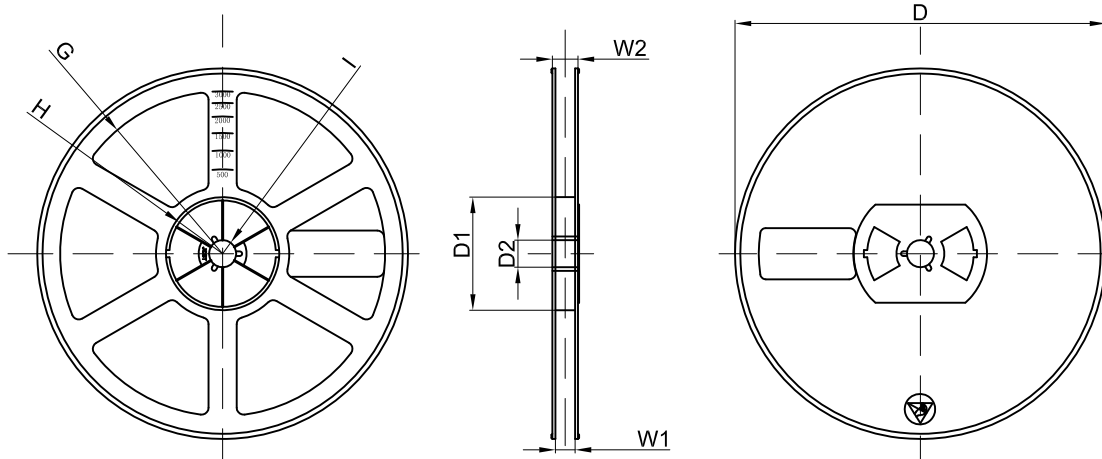

| Dimensions are in millimeter |         |       |       |        |        |       |      |       |
|------------------------------|---------|-------|-------|--------|--------|-------|------|-------|
| Reel Option                  | D       | D1    | D2    | G      | H      | I     | W1   | W2    |
| 7"Dia                        | Ø178.00 | 54.40 | 13.00 | R78.00 | R25.60 | R6.50 | 9.50 | 12.30 |

| REEL     | Reel Size | Box        | Box Size(mm) | Carton      | Carton Size(mm) | G.W.(kg) |
|----------|-----------|------------|--------------|-------------|-----------------|----------|
| 3000 pcs | 7 inch    | 45,000 pcs | 203×203×195  | 180,000 pcs | 438×438×220     |          |