

FEATURES

- High Switching Speed:Max.50ns.
- High Continuous Reverse Voltage:300V.
- Electrically Insulated Diodes.

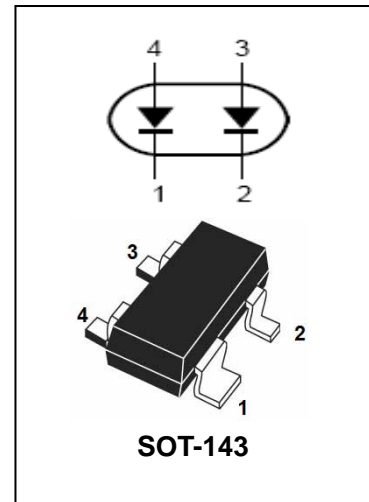

APPLICATIONS

- General application.

ORDERING INFORMATION

Type No.	Marking	Package Code
BAW101	AB	SOT-143

MAXIMUM RATING @ Ta=25°C unless otherwise specified

Characteristic	Symbol	Limits	Unit
Repetitive Peak Reverse Voltage Series connection	V_{RRM}	300 600	V
Continuous Reverse Voltage Series connection	V_R	300 600	V
Continuous Forward Current single diodes(note1) double diodes(note1)	I_F	250 140	mA
Repetitive Peak Forward Current	I_{FRM}	625	mA
Non-repetitive Peak Forward Current $t=1\mu s$	I_{FSM}	4.5	A
Power Dissipation(note1)	P_d	350	mW
Junction Temperature	T_j	-65 to +150	°C
Storage Temperature	T_{STG}	150	°C
Operating Ambient Temperature	T_{amb}	-65	°C

Note:1 Device mounted on an FR4 Printed-circuit board, cathode-lead mounting pad=1cm².

ELECTRICAL CHARACTERISTICS @ Ta=25°C unless otherwise specified

Characteristic	Symbol	Min	Typ	MAX	UNIT	Test Condition
Reverse Breakdown Voltage	$V_{(BR)R}$	300	-	-	V	$I_R = 100\mu A$
Forward Voltage	V_F	-	-	1.1	V	$I_F = 100mA$ Note 1
Reverse Leakage Current	I_R	-	-	150 50	nA μA	$V_R = 250V$ $V_R = 250V, T_j = 150^\circ C$
Diodes Capacitance	C_d	-	-	2	pF	$V_R = 0V, f = 1.0MHz$
Reverse Recovery Time	t_{rr}	-	-	50	ns	$I_F = I_R = 30mA, R_L = 100\Omega$ $I_{rr} = 0.1 * I_R$

Note: 1. Pulse tesse: pulse width=300 μs ; $\delta = 0.02$

TYPICAL CHARACTERISTICS @ Ta=25°C unless otherwise specified

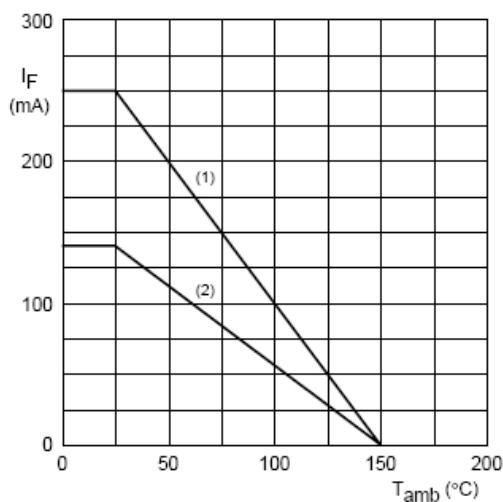

(1) Single diode loaded. (2) Double diode loaded.

Device mounted on an FR4 printed-circuit board.
Cathode-lead mounting pad = 1 cm².

Fig. 1 Maximum permissible continuous forward current as a function of ambient temperature.

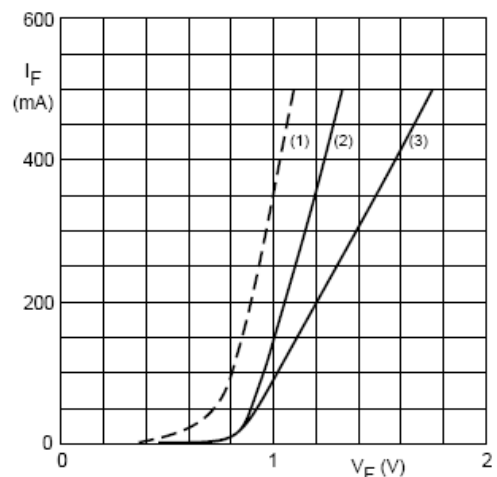

(1) $T_j = 150^\circ C$; typical values.

(2) $T_j = 25^\circ C$; typical values.

(3) $T_j = 25^\circ C$; maximum values.

Fig. 2 Forward current as a function of forward voltage.

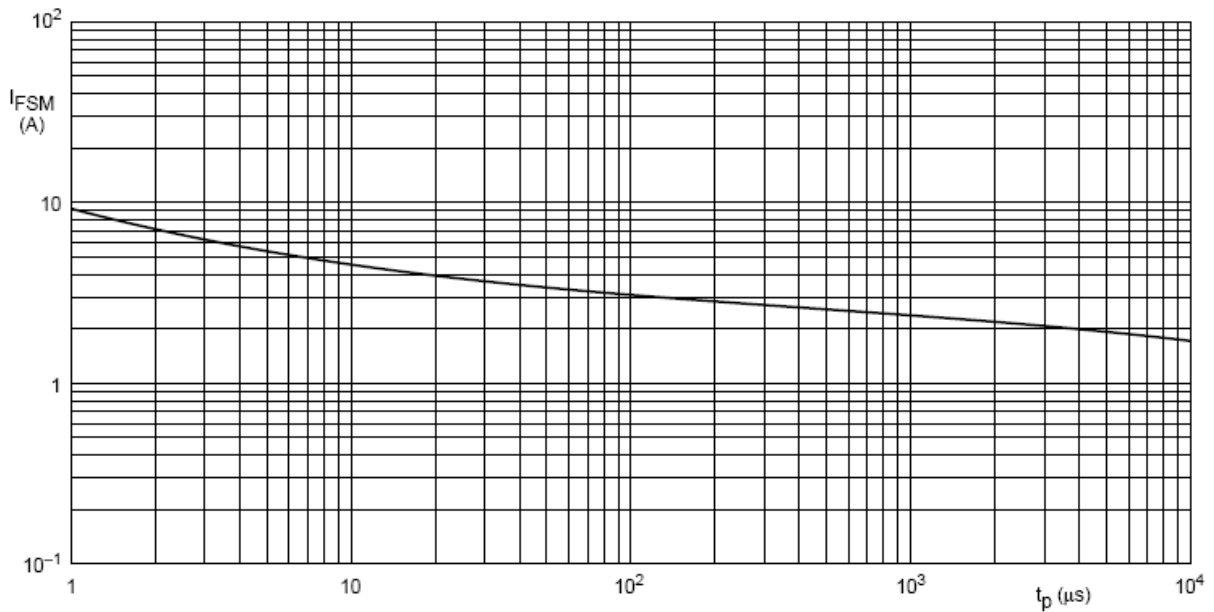

Based on square wave currents.
 $T_j = 25$ °C prior to surge.

Fig. 3 Maximum permissible non-repetitive peak forward current as a function of pulse duration.

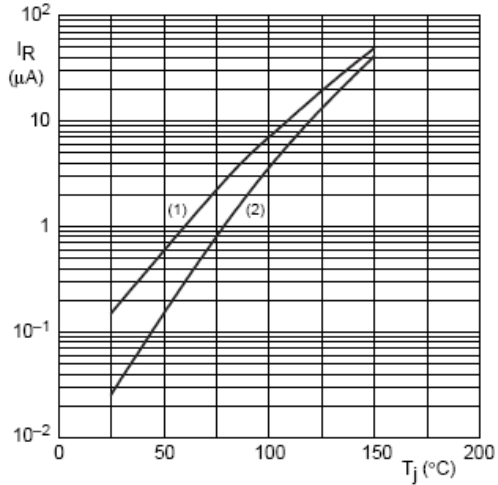

(1) $V_R = V_{RMAX}$: maximum values.
 (2) $V_R = V_{RMAX}$: typical values.

Fig. 4 Reverse current as a function of junction temperature.

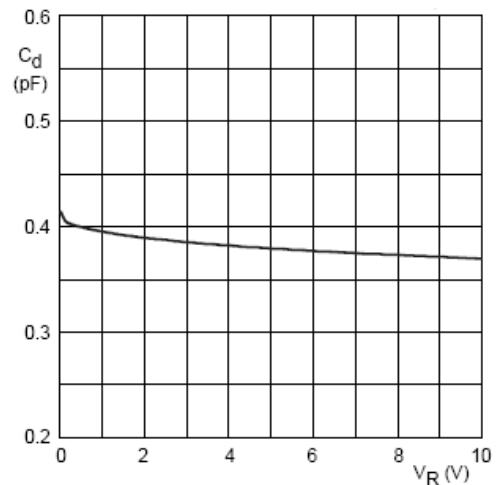

$f = 1$ MHz; $T_j = 25$ °C.

Fig. 5 Diode capacitance as a function of reverse voltage; typical values.

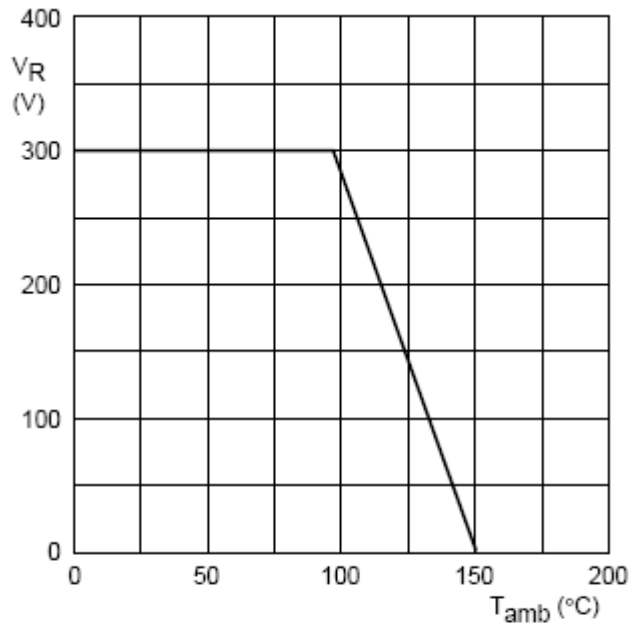
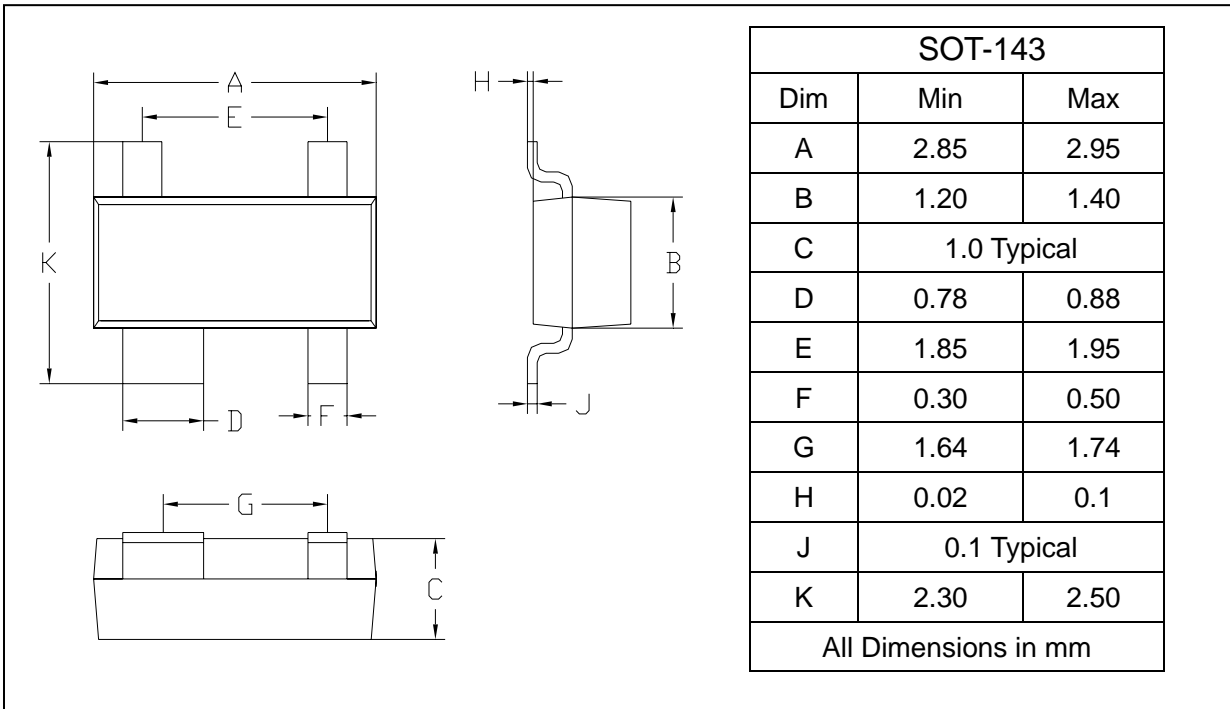
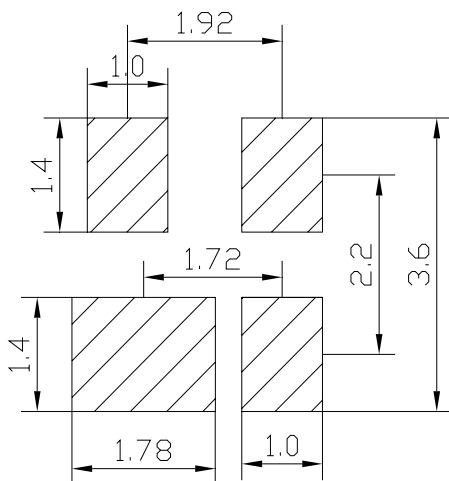

Fig. 6 Maximum permissible continuous reverse voltage as a function of ambient temperature.

PACKAGE OUTLINE

Plastic surface mounted package

SOT-143

SOLDERING FOOTPRINT

Unit : mm

PACKAGE INFORMATION

Device	Package	Shipping
BAW101	SOT-143	3000/ Tape&Reel