

Amplifier Transistors

PNP Silicon

BC307
BC307B
BC307C
BC308C

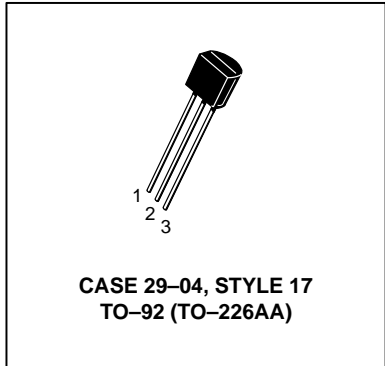
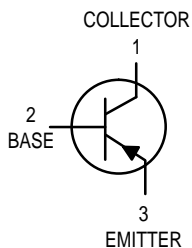

MAXIMUM RATINGS

Rating	Symbol	BC307, B, C	BC308C	Unit
Collector–Emitter Voltage	V_{CEO}	-45	-25	Vdc
Collector–Base Voltage	V_{CBO}	-50	-30	Vdc
Emitter–Base Voltage	V_{EBO}	-5.0		Vdc
Collector Current — Continuous	I_C	-100		mAdc
Total Device Dissipation @ $T_A = 25^\circ\text{C}$ Derate above 25°C	P_D	350	2.8	mW mW/ $^\circ\text{C}$
Total Device Dissipation @ $T_C = 25^\circ\text{C}$ Derate above 25°C	P_D	1.0	8.0	Watts mW/ $^\circ\text{C}$
Operating and Storage Junction Temperature Range	T_J, T_{stg}	-55 to +150		$^\circ\text{C}$

THERMAL CHARACTERISTICS

Characteristic	Symbol	Max	Unit
Thermal Resistance, Junction to Ambient	$R_{\theta JA}$	357	$^\circ\text{C}/\text{W}$
Thermal Resistance, Junction to Case	$R_{\theta JC}$	125	$^\circ\text{C}/\text{W}$

ELECTRICAL CHARACTERISTICS ($T_A = 25^\circ\text{C}$ unless otherwise noted)

Characteristic	Symbol	Min	Typ	Max	Unit
----------------	--------	-----	-----	-----	------

OFF CHARACTERISTICS

Collector–Emitter Breakdown Voltage ($I_C = -2.0$ mAdc, $I_B = 0$)	BC307,B,C BC308C	$V_{(BR)CEO}$	-45 -25	— —	— —	Vdc
Emitter–Base Breakdown Voltage ($I_E = -100$ μ Adc, $I_C = 0$)	BC307,B,C BC308C	$V_{(BR)EBO}$	-5.0 -5.0	— —	— —	Vdc
Collector–Emitter Leakage Current ($V_{CES} = -50$ V, $V_{BE} = 0$) ($V_{CES} = -30$ V, $V_{BE} = 0$) ($V_{CES} = -50$ V, $V_{BE} = 0$) $T_A = 125^\circ\text{C}$ ($V_{CES} = -30$ V, $V_{BE} = 0$) $T_A = 125^\circ\text{C}$	BC307,B,C BC308C BC307,B,C BC308C	I_{CES}	— — — —	-0.2 -0.2 -0.2 -0.2	-15 -15 -4.0 -4.0	nAdc μA

BC307 BC307B BC307C BC308C
ELECTRICAL CHARACTERISTICS ($T_A = 25^\circ\text{C}$ unless otherwise noted) (Continued)

Characteristic	Symbol	Min	Typ	Max	Unit
ON CHARACTERISTICS					
DC Current Gain ($I_C = -10 \mu\text{A}$, $V_{CE} = -5.0 \text{ Vdc}$)	h_{FE}	—	150	—	—
	BC307B	—	270	—	—
	BC307C/308C	—	—	—	—
($I_C = -2.0 \text{ mA}$, $V_{CE} = -5.0 \text{ Vdc}$)	BC307	120	—	800	—
	BC307B/308B	200	290	460	—
	BC307C/308C	420	500	800	—
($I_C = -100 \text{ mA}$, $V_{CE} = -5.0 \text{ Vdc}$)	BC307B	—	180	—	—
	BC307C/308C	—	300	—	—
Collector–Emitter Saturation Voltage ($I_C = -10 \text{ mA}$, $I_B = -0.5 \text{ mA}$) ($I_C = -10 \text{ mA}$, $I_B = \text{see Note 1}$) ($I_C = -100 \text{ mA}$, $I_B = -5.0 \text{ mA}$)	$V_{CE(\text{sat})}$	—	-0.10	-0.3	Vdc
		—	-0.30	-0.6	
		—	-0.25	—	
Base–Emitter Saturation Voltage ($I_C = -10 \text{ mA}$, $I_B = -0.5 \text{ mA}$) ($I_C = -100 \text{ mA}$, $I_B = -5.0 \text{ mA}$)	$V_{BE(\text{sat})}$	—	-0.7	—	Vdc
		—	-1.0	—	
Base–Emitter On Voltage ($I_C = -2.0 \text{ mA}$, $V_{CE} = -5.0 \text{ Vdc}$)	$V_{BE(\text{on})}$	-0.55	-0.62	-0.7	Vdc

DYNAMIC CHARACTERISTICS

Current–Gain — Bandwidth Product ($I_C = -10 \text{ mA}$, $V_{CE} = -5.0 \text{ Vdc}$, $f = 100 \text{ MHz}$)	f_T	—	280	—	MHz
	BC307,B,C	—	320	—	
	BC308C	—	—	—	
Common Base Capacitance ($V_{CB} = -10 \text{ Vdc}$, $I_C = 0$, $f = 1.0 \text{ MHz}$)	C_{cbo}	—	—	6.0	pF
Noise Figure ($I_C = -0.2 \text{ mA}$, $V_{CE} = -5.0 \text{ Vdc}$, $R_S = 2.0 \text{ k}\Omega$, $f = 1.0 \text{ kHz}$)	NF	—	2.0	10	dB
	BC307,B,C	—	—	—	
($I_C = -0.2 \text{ mA}$, $V_{CE} = -5.0 \text{ Vdc}$, $R_S = 2.0 \text{ k}\Omega$, $f = 1.0 \text{ kHz}$, $f = 200 \text{ Hz}$)	BC308C	—	2.0	10	

1. $I_C = -10 \text{ mA}$ on the constant base current characteristic, which yields the point $I_C = -11 \text{ mA}$, $V_{CE} = -1.0 \text{ V}$.

TYPICAL CHARACTERISTICS

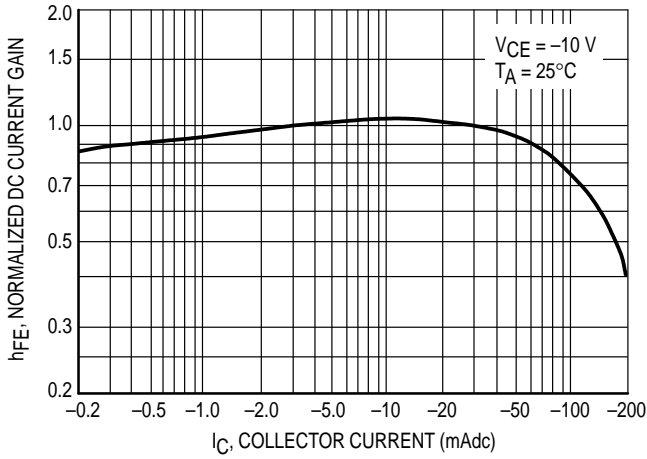

Figure 1. Normalized DC Current Gain

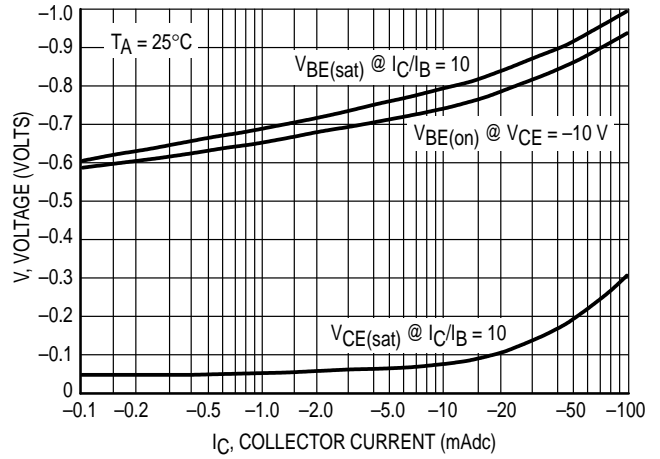

Figure 2. "Saturation" and "On" Voltages

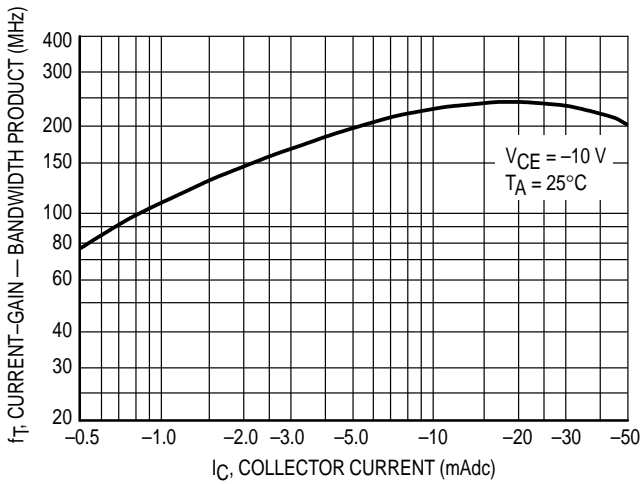

Figure 3. Current-Gain — Bandwidth Product

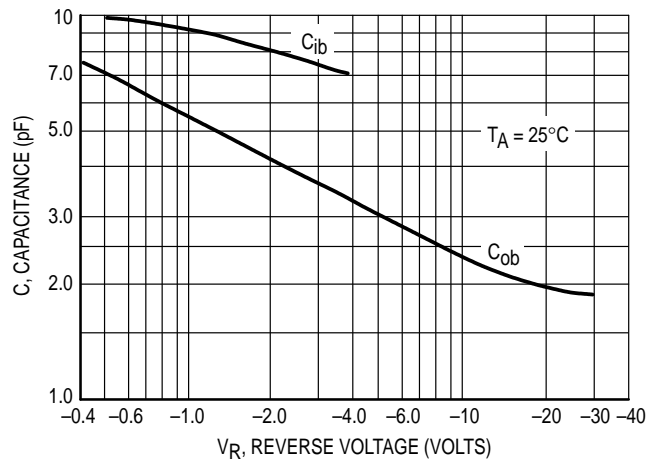

Figure 4. Capacitances

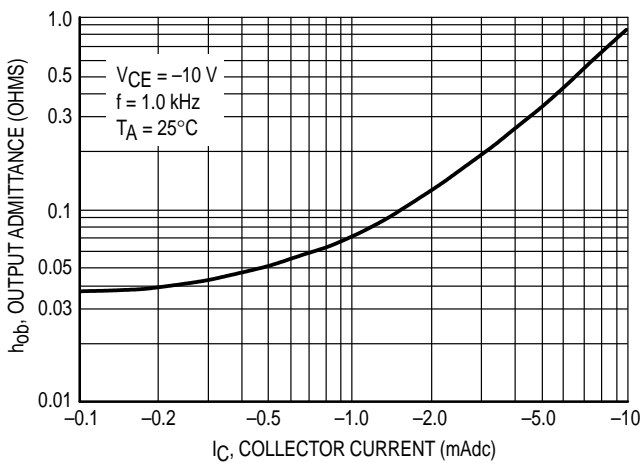

Figure 5. Output Admittance

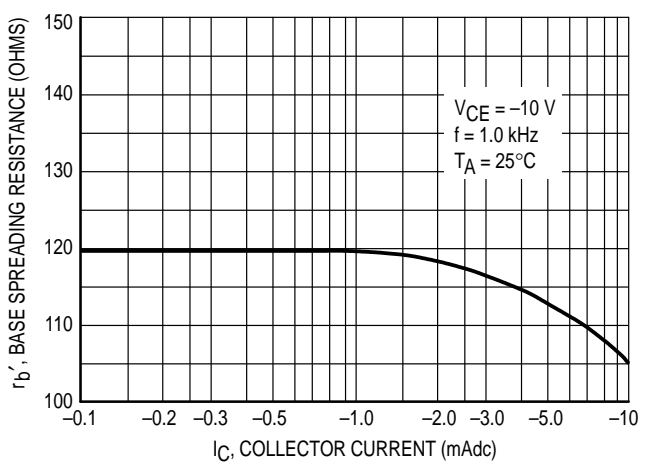
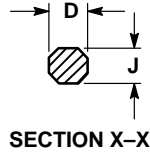
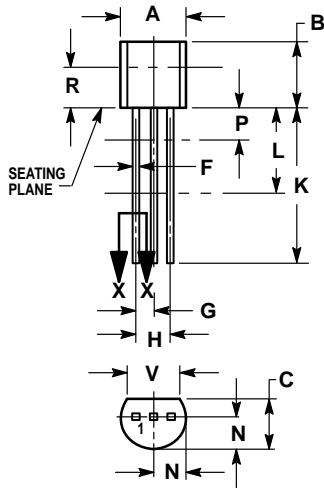

Figure 6. Base Spreading Resistance

PACKAGE DIMENSIONS



CASE 029-04
(TO-226AA)
ISSUE AD

NOTES:

1. DIMENSIONING AND TOLERANCING PER ANSI Y14.5M, 1982.
2. CONTROLLING DIMENSION: INCH.
3. CONTOUR OF PACKAGE BEYOND DIMENSION R IS UNCONTROLLED.
4. DIMENSION F APPLIES BETWEEN P AND L. DIMENSION D AND J APPLY BETWEEN L AND K. MINIMUM LEAD DIMENSION IS UNCONTROLLED IN P AND BEYOND DIMENSION K MINIMUM.

DIM	INCHES		MILLIMETERS	
	MIN	MAX	MIN	MAX
A	0.175	0.205	4.45	5.20
B	0.170	0.210	4.32	5.33
C	0.125	0.165	3.18	4.19
D	0.016	0.022	0.41	0.55
F	0.016	0.019	0.41	0.48
G	0.045	0.055	1.15	1.39
H	0.095	0.105	2.42	2.66
J	0.015	0.020	0.39	0.50
K	0.500	—	12.70	—
L	0.250	—	6.35	—
N	0.080	0.105	2.04	2.66
P	—	0.100	—	2.54
R	0.115	—	2.93	—
V	0.135	—	3.43	—

STYLE 17:

- PIN 1. COLLECTOR
2. BASE
3. EMITTER

Motorola reserves the right to make changes without further notice to any products herein. Motorola makes no warranty, representation or guarantee regarding the suitability of its products for any particular purpose, nor does Motorola assume any liability arising out of the application or use of any product or circuit, and specifically disclaims any and all liability, including without limitation consequential or incidental damages. "Typical" parameters which may be provided in Motorola data sheets and/or specifications can and do vary in different applications and actual performance may vary over time. All operating parameters, including "Typicals" must be validated for each customer application by customer's technical experts. Motorola does not convey any license under its patent rights nor the rights of others. Motorola products are not designed, intended, or authorized for use as components in systems intended for surgical implant into the body, or other applications intended to support or sustain life, or for any other application in which the failure of the Motorola product could create a situation where personal injury or death may occur. Should Buyer purchase or use Motorola products for any such unintended or unauthorized application, Buyer shall indemnify and hold Motorola and its officers, employees, subsidiaries, affiliates, and distributors harmless against all claims, costs, damages, and expenses, and reasonable attorney fees arising out of, directly or indirectly, any claim of personal injury or death associated with such unintended or unauthorized use, even if such claim alleges that Motorola was negligent regarding the design or manufacture of the part. Motorola and  are registered trademarks of Motorola, Inc. Motorola, Inc. is an Equal Opportunity/Affirmative Action Employer.

Mfax is a trademark of Motorola, Inc.

How to reach us:

USA/EUROPE/Locations Not Listed: Motorola Literature Distribution;
P.O. Box 5405, Denver, Colorado 80217. 303-675-2140 or 1-800-441-2447

JAPAN: Nippon Motorola Ltd.: SPD, Strategic Planning Office, 4-32-1,
Nishi-Gotanda, Shinagawa-ku, Tokyo 141, Japan. 81-3-5487-8488

Mfax™: RMFAX0@email.sps.mot.com – TOUCHTONE 602-244-6609
– US & Canada ONLY 1-800-774-1848

ASIA/PACIFIC: Motorola Semiconductors H.K. Ltd.; 8B Tai Ping Industrial Park,
51 Ting Kok Road, Tai Po, N.T., Hong Kong. 852-26629298

INTERNET: <http://motorola.com/sp>

