

NPN Silicon AF Transistor

BC 368

- High current gain
- High collector current
- Low collector-emitter saturation voltage
- Complementary type: BC 369 (PNP)

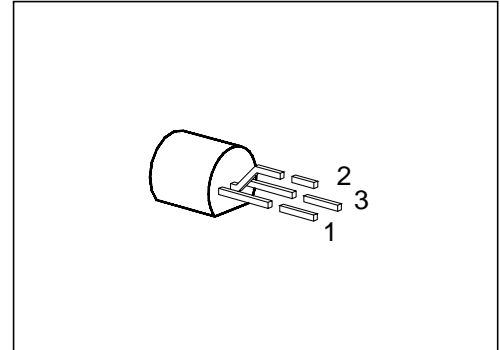

Type	Marking	Ordering Code	Pin Configuration			Package ¹⁾
			1	2	3	
BC 368	–	C62702-C747	E	C	B	TO-92

Maximum Ratings

Parameter	Symbol	Values	Unit
Collector-emitter voltage	V_{CE0}	20	V
Collector-base voltage	V_{CB0}	25	
Emitter-base voltage	V_{EB0}	5	
Collector current	I_C	1	A
Peak collector current	I_{CM}	2	
Base current	I_B	100	mA
Peak base current	I_{BM}	200	
Total power dissipation, $T_c = 90\text{ °C}^2)$	P_{tot}	0.8 (1)	W
Junction temperature	T_j	150	°C
Storage temperature range	T_{stg}	– 65 ... + 150	

Thermal Resistance

Junction - ambient ²⁾	R_{thJA}	≤ 156	K/W
Junction - case ³⁾	R_{thJC}	≤ 75	

¹⁾ For detailed information see chapter Package Outlines.

²⁾ If transistors with max. 4 mm lead length are fixed on PCBs with a min. 10 mm × 10 mm large copper area for the collector terminal, $R_{thJA} = 125\text{ K/W}$ and thus $P_{tot\ max} = 1\text{ W}$ at $T_A = 25\text{ °C}$.

³⁾ Mounted on Al heat sink 15 mm × 25 mm × 0.5 mm.

Electrical Characteristics

at $T_A = 25\text{ °C}$, unless otherwise specified.

Parameter	Symbol	Values			Unit
		min.	typ.	max.	

DC characteristics

Collector-emitter breakdown voltage $I_C = 30\text{ mA}$	$V_{(BR)CE0}$	20	–	–	V
Collector-base breakdown voltage $I_C = 10\text{ }\mu\text{A}$	$V_{(BR)CB0}$	25	–	–	
Emitter-base breakdown voltage $I_E = 1\text{ }\mu\text{A}$	$V_{(BR)EB0}$	5	–	–	
Collector cutoff current $V_{CB} = 25\text{ V}$ $V_{CB} = 25\text{ V}, T_A = 150\text{ °C}$	I_{CB0}	–	–	100 10	nA μA
Emitter cutoff current $V_{EB} = 5\text{ V}$	I_{EB0}	–	–	100	nA
DC current gain $I_C = 5\text{ mA}; V_{CE} = 10\text{ V}$ $I_C = 500\text{ mA}; V_{CE} = 1\text{ V}^1)$ $I_C = 1\text{ A}; V_{CE} = 1\text{ V}^1)$	h_{FE}	50 85 60	– 160 –	– 375 –	–
Collector-emitter saturation voltage ¹⁾ $I_C = 1\text{ A}; I_B = 100\text{ mA}$	V_{CEsat}	–	–	0.5	V
Base-emitter voltage ¹⁾ $I_C = 5\text{ mA}; V_{CE} = 10\text{ V}$ $I_C = 1\text{ A}; V_{CE} = 1\text{ V}$	V_{BE}	– –	0.6 –	– 1	

AC characteristics

Transition frequency $I_C = 100\text{ mA}, V_{CE} = 5\text{ V}, f = 20\text{ MHz}$	f_T	–	100	–	MHz
---	-------	---	-----	---	-----

¹⁾ Pulse test: $t \leq 300\text{ }\mu\text{s}, D \leq 2\text{ %}$.

Total power dissipation $P_{tot} = f(T_A; T_C)$

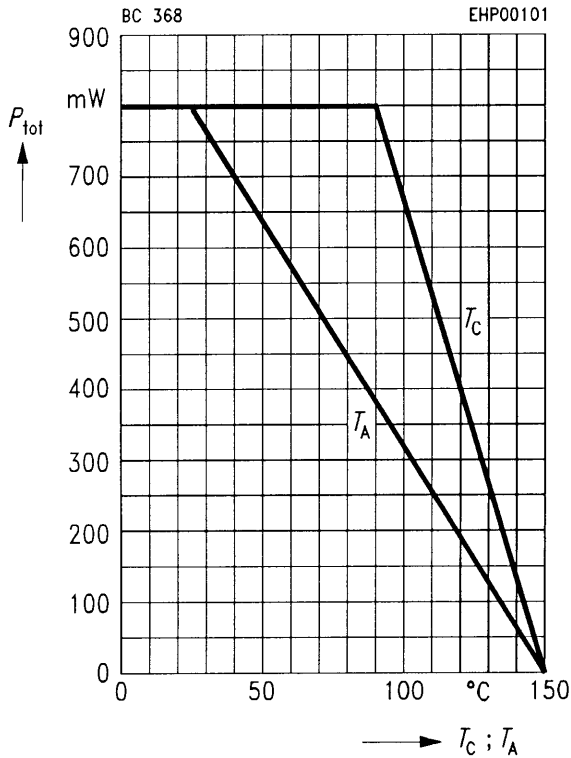

**Collector cutoff current $I_{CBO} = f(T_A)$
 $V_{CB} = 25 V$**

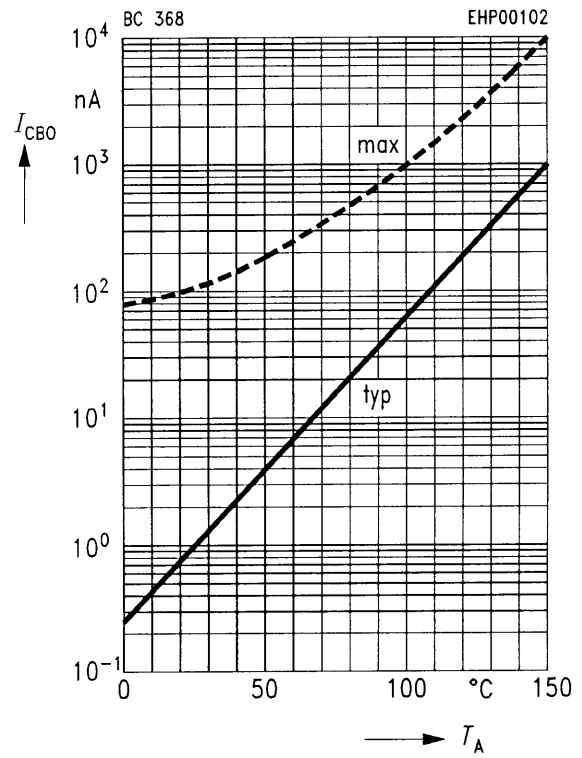

Permissible pulse load $R_{thJA} = f(t_p)$

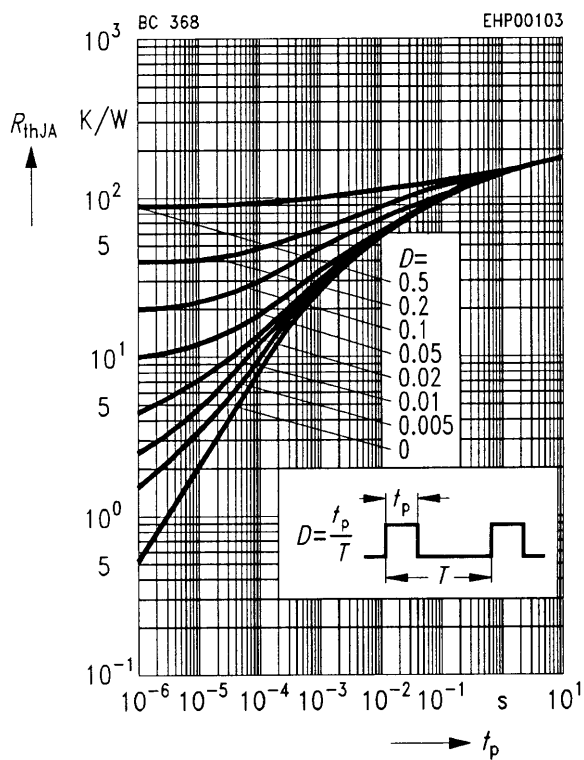

**DC current gain $h_{FE} = f(I_C)$
 $V_{CE} = 1 V, T_A = 25 °C$**

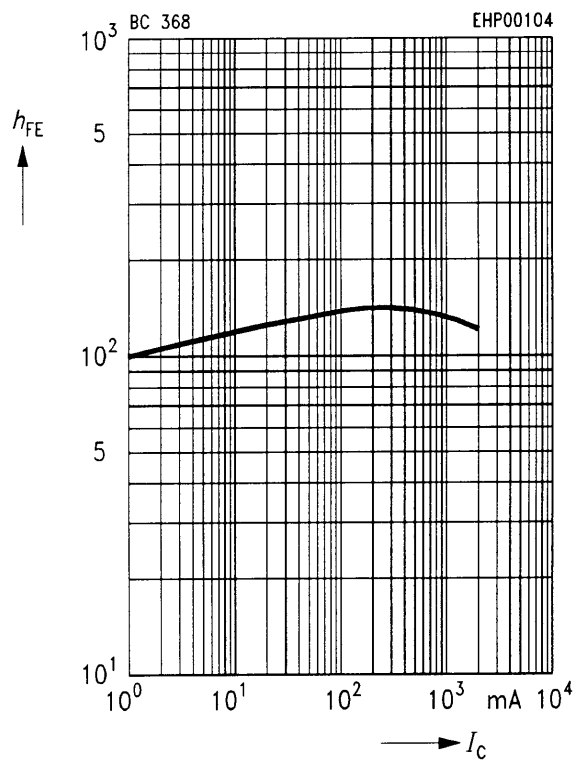

Collector current $I_C = f(V_{BE})$

$V_{CE} = 1 \text{ V}$

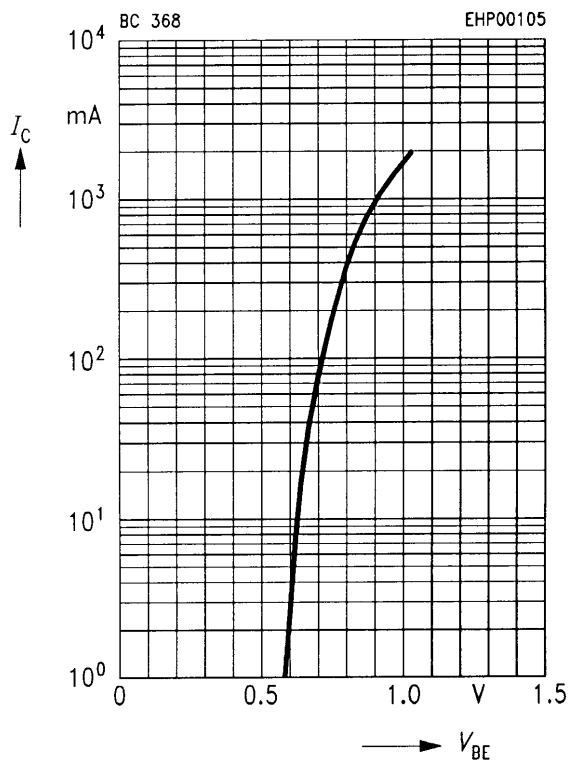

Collector-emitter saturation voltage $V_{CEsat} = f(I_C)$

$V_{CEsat} = f(I_C)$

$h_{FE} = 10, T_A = 25 \text{ }^\circ\text{C}$

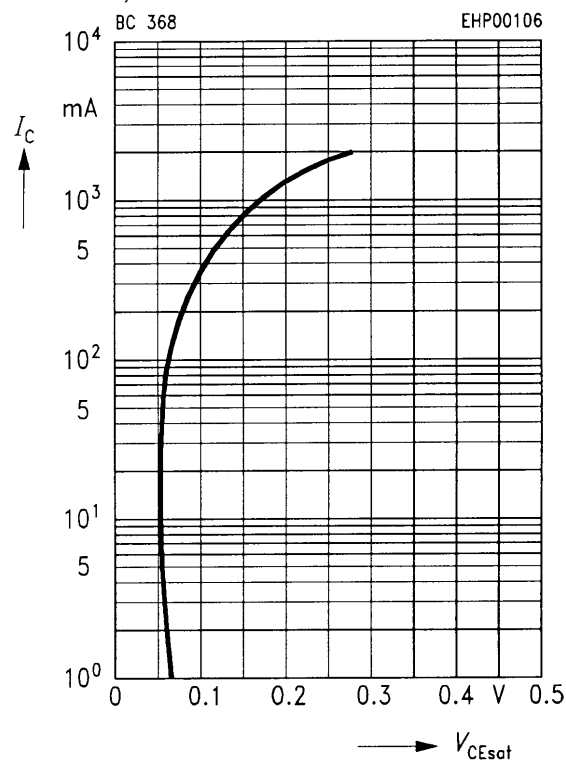

Transition frequency $f_T = f(I_C)$

$V_{CE} = 5 \text{ V}, f = 20 \text{ MHz}$

