



November 2014

# BC546 / BC547 / BC548 / BC549 / BC550 NPN Epitaxial Silicon Transistor

## Features

- Switching and Amplifier
- High-Voltage: BC546,  $V_{CEO} = 65\text{ V}$
- Low-Noise: BC549, BC550
- Complement to BC556, BC557, BC558, BC559, and BC560

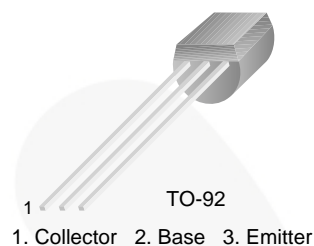

## Ordering Information

Part Number	Marking	Package	Packing Method
BC546ABU	BC546A	TO-92 3L	Bulk
BC546ATA	BC546A	TO-92 3L	Ammo
BC546BTA	BC546B	TO-92 3L	Ammo
BC546BTF	BC546B	TO-92 3L	Tape and Reel
BC546CTA	BC546C	TO-92 3L	Ammo
BC547ATA	BC547A	TO-92 3L	Ammo
BC547B	BC547B	TO-92 3L	Bulk
BC547BBU	BC547B	TO-92 3L	Bulk
BC547BTA	BC547B	TO-92 3L	Ammo
BC547BTF	BC547B	TO-92 3L	Tape and Reel
BC547CBU	BC547C	TO-92 3L	Bulk
BC547CTA	BC547C	TO-92 3L	Ammo
BC547CTFR	BC547C	TO-92 3L	Tape and Reel
BC548BU	BC548	TO-92 3L	Bulk
BC548BTA	BC548B	TO-92 3L	Ammo
BC548CTA	BC548C	TO-92 3L	Ammo
BC549BTA	BC549B	TO-92 3L	Ammo
BC549BTF	BC549B	TO-92 3L	Tape and Reel
BC549CTA	BC549C	TO-92 3L	Ammo
BC550CBU	BC550C	TO-92 3L	Bulk
BC550CTA	BC550C	TO-92 3L	Ammo

BC546 / BC547 / BC548 / BC549 / BC550 — NPN Epitaxial Silicon Transistor

## Absolute Maximum Ratings

Stresses exceeding the absolute maximum ratings may damage the device. The device may not function or be operable above the recommended operating conditions and stressing the parts to these levels is not recommended. In addition, extended exposure to stresses above the recommended operating conditions may affect device reliability. The absolute maximum ratings are stress ratings only. Values are at  $T_A = 25^\circ\text{C}$  unless otherwise noted.

Symbol	Parameter	Value	Unit	
$V_{CBO}$	Collector-Base Voltage	BC546	80	V
		BC547 / BC550	50	
		BC548 / BC549	30	
$V_{CEO}$	Collector-Emitter Voltage	BC546	65	V
		BC547 / BC550	45	
		BC548 / BC549	30	
$V_{EBO}$	Emitter-Base Voltage	BC546 / BC547	6	V
		BC548 / BC549 / BC550	5	
$I_C$	Collector Current (DC)	100	mA	
$P_C$	Collector Power Dissipation	500	mW	
$T_J$	Junction Temperature	150	$^\circ\text{C}$	
$T_{STG}$	Storage Temperature Range	-65 to +150	$^\circ\text{C}$	

## Electrical Characteristics

Values are at  $T_A = 25^\circ\text{C}$  unless otherwise noted.

Symbol	Parameter	Conditions	Min.	Typ.	Max.	Unit
$I_{CBO}$	Collector Cut-Off Current	$V_{CB} = 30\text{ V}, I_E = 0$			15	nA
$h_{FE}$	DC Current Gain	$V_{CE} = 5\text{ V}, I_C = 2\text{ mA}$	110		800	
$V_{CE(sat)}$	Collector-Emitter Saturation Voltage	$I_C = 10\text{ mA}, I_B = 0.5\text{ mA}$		90	250	mV
		$I_C = 100\text{ mA}, I_B = 5\text{ mA}$		250	600	
$V_{BE(sat)}$	Base-Emitter Saturation Voltage	$I_C = 10\text{ mA}, I_B = 0.5\text{ mA}$		700		mV
		$I_C = 100\text{ mA}, I_B = 5\text{ mA}$		900		
$V_{BE(on)}$	Base-Emitter On Voltage	$V_{CE} = 5\text{ V}, I_C = 2\text{ mA}$	580	660	700	mV
		$V_{CE} = 5\text{ V}, I_C = 10\text{ mA}$			720	
$f_T$	Current Gain Bandwidth Product	$V_{CE} = 5\text{ V}, I_C = 10\text{ mA}, f = 100\text{ MHz}$		300		MHz
$C_{ob}$	Output Capacitance	$V_{CB} = 10\text{ V}, I_E = 0, f = 1\text{ MHz}$		3.5	6.0	pF
$C_{ib}$	Input Capacitance	$V_{EB} = 0.5\text{ V}, I_C = 0, f = 1\text{ MHz}$		9		pF
NF	Noise Figure	BC546 / BC547 / BC548	$V_{CE} = 5\text{ V}, I_C = 200\text{ }\mu\text{A}, f = 1\text{ kHz}, R_G = 2\text{ k}\Omega$	2.0	10.0	dB
		BC549 / BC550		1.2	4.0	
		BC549	$V_{CE} = 5\text{ V}, I_C = 200\text{ }\mu\text{A}, R_G = 2\text{ k}\Omega, f = 30\text{ to }15000\text{ MHz}$	1.4	4.0	
		BC550		1.4	3.0	

## $h_{FE}$ Classification

Classification	A	B	C
$h_{FE}$	110 ~ 220	200 ~ 450	420 ~ 800

## Typical Performance Characteristics

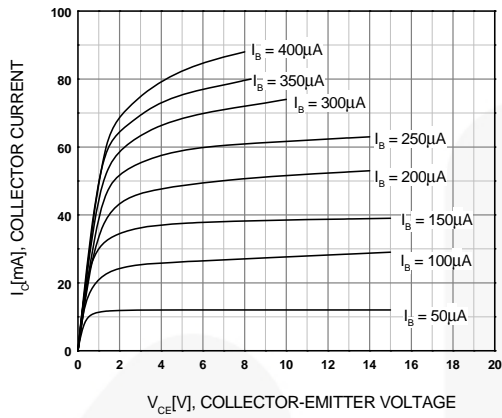

Figure 1. Static Characteristic

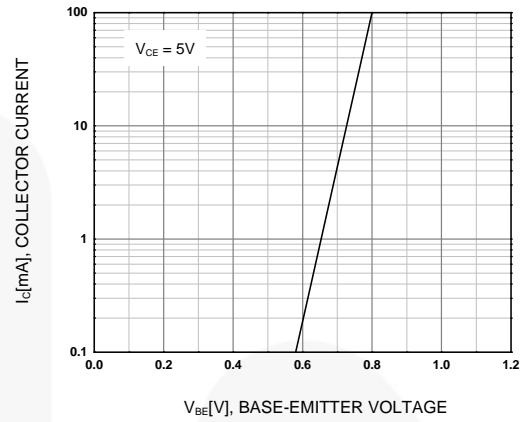

Figure 2. Transfer Characteristic

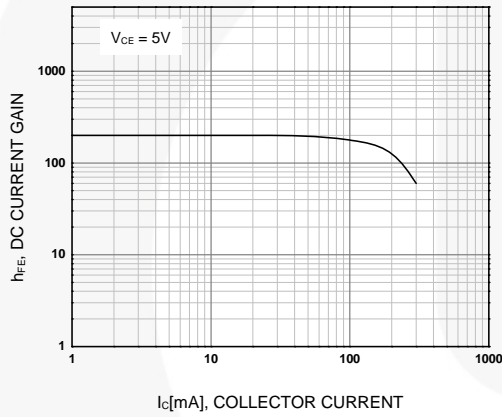

Figure 3. DC Current Gain

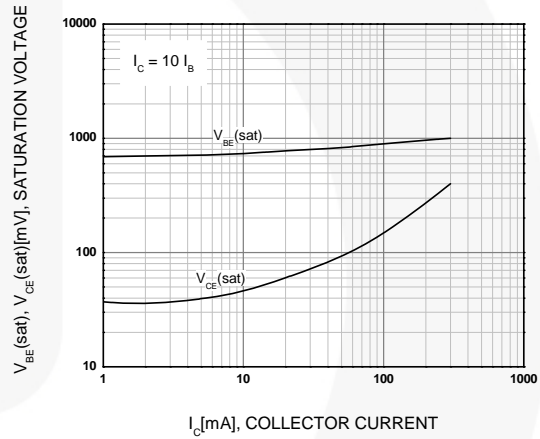

Figure 4. Base-Emitter Saturation Voltage and Collector-Emitter Saturation Voltage

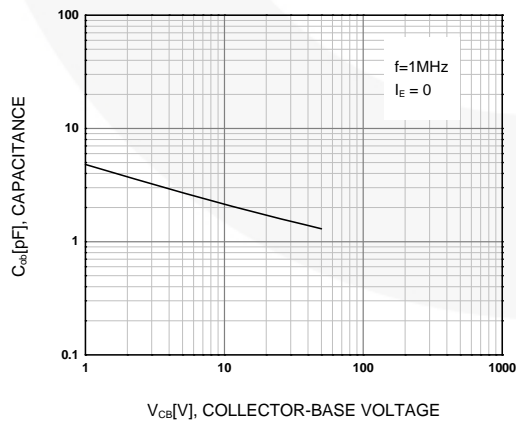

Figure 5. Output Capacitance

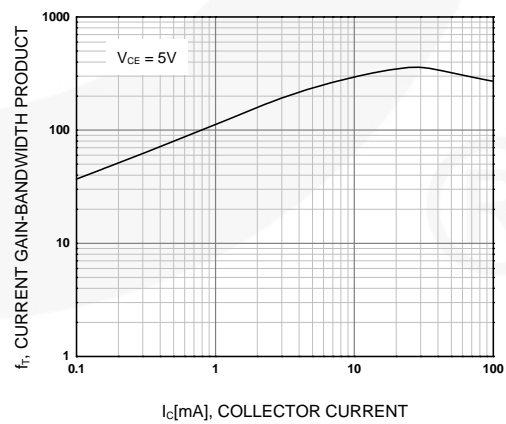
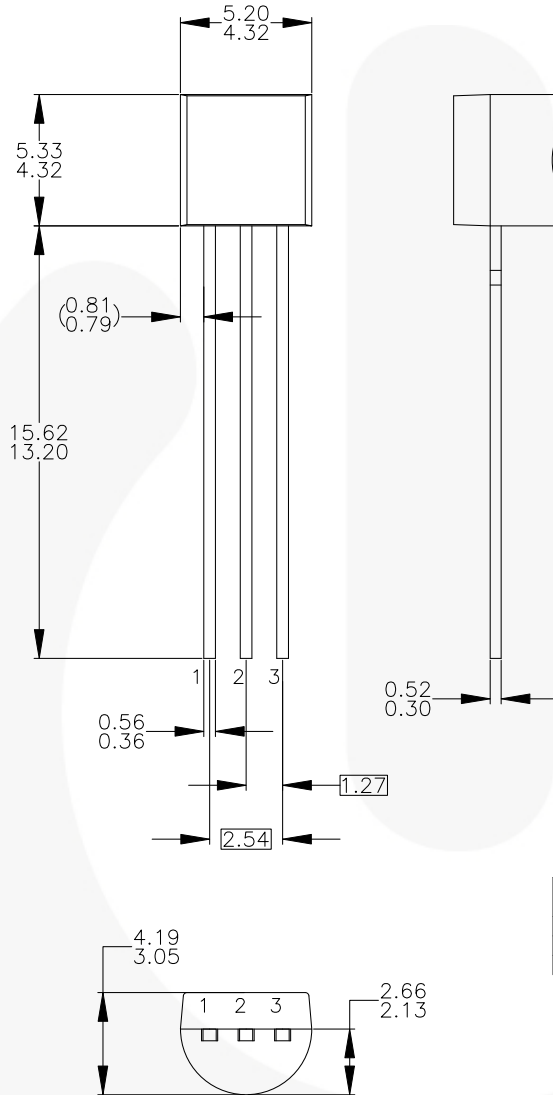

Figure 6. Current Gain Bandwidth Product

Physical Dimensions



NOTES: UNLESS OTHERWISE SPECIFIED

- A) DRAWING WITH REFERENCE TO JEDEC TO-92 RECOMMENDATIONS.
- B) ALL DIMENSIONS ARE IN MILLIMETERS.
- C) DRAWING CONFORMS TO ASME Y14.5M-1994.
- D) TO-92 (92,94,96,97,98) PIN CONFIGURATION:

PIN	92			94			96			97			98		
	P	F	M	P	F	M	B	F	M	P	F	M	P	F	M
1	E	S	S	E	S	S	B	D	G	C	G	D	C	G	D
2	B	D	G	C	G	D	E	S	S	B	D	G	E	S	S
3	C	G	D	B	D	G	C	G	D	E	S	S	B	D	G

LEGEND:

P - BIPOLAR E - EMITTER D - DRAIN  
 F - JFET B - BASE S - SOURCE  
 M - DMOS C - COLLECTOR G - GATE

- E) FOR PACKAGE 92, 94, 96, 97 AND 98: PIN CONFIGURATION DRAIN "D" AND SOURCE "S" ARE INTERCHANGEABLE AT JFET "F" OPTION.
- F) DRAWING FILENAME: MKT-ZA03DREV3.

Figure 7. 3-Lead, TO-92, JEDEC TO-92 Compliant Straight Lead Configuration, Bulk Type

Physical Dimensions (Continued)

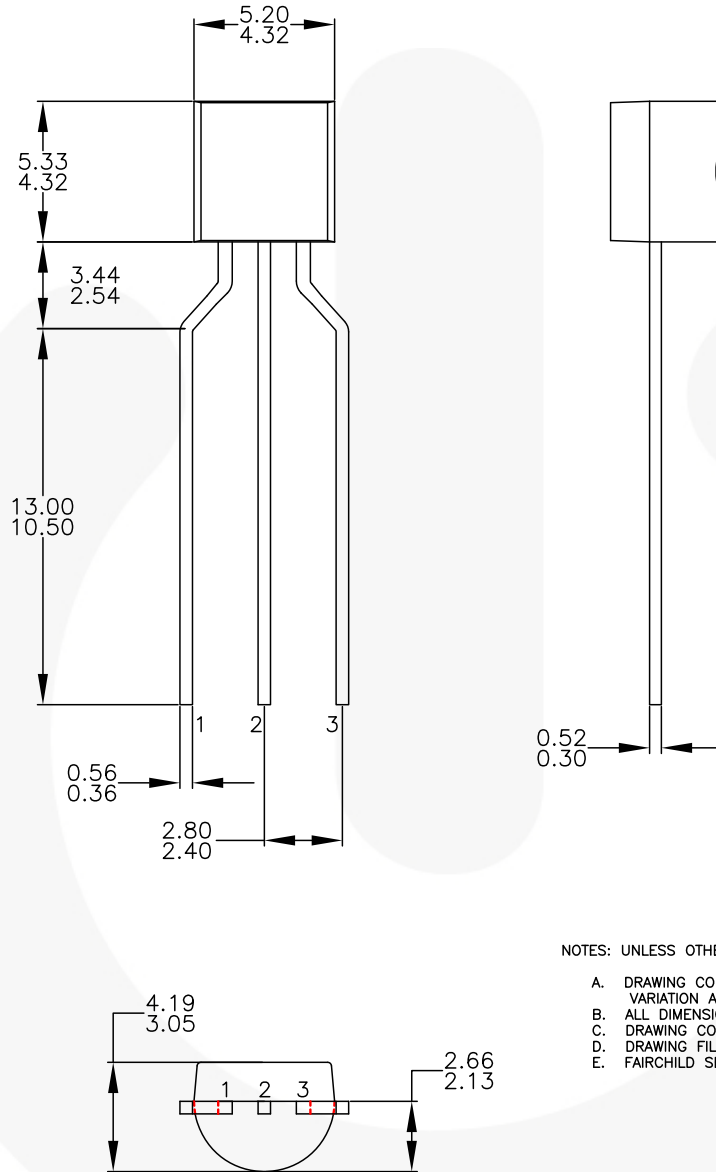

NOTES: UNLESS OTHERWISE SPECIFIED





- A. DRAWING CONFORMS TO JEDEC MS-013, VARIATION AC.
- B. ALL DIMENSIONS ARE IN MILLIMETERS.
- C. DRAWING CONFORMS TO ASME Y14.5M-2009.
- D. DRAWING FILENAME: MKT-ZA03FREV3.
- E. FAIRCHILD SEMICONDUCTOR.

Figure 8. 3-Lead, TO-92, Molded, 0.2 In Line Spacing Lead Form, Ammo, Tape and Reel Type



### TRADEMARKS

The following includes registered and unregistered trademarks and service marks, owned by Fairchild Semiconductor and/or its global subsidiaries, and is not intended to be an exhaustive list of all such trademarks.

- |  |  |   |   |
|--|--|---|---|
| AccuPower™   | F-PFS™   | OPTOPLANAR®   |  SYSTEM GENERAL® |
| Awinda®  | FRFET®   |  ® | TinyBoost®  |
| AX-CAP®*   | Global Power Resource™                         | PowerTrench®  | TinyBuck®   |
| BitSiC™  | GreenBridge™                                   | PowerXS™  | TinyCalc™   |
| Build it Now™  | Green FPS™                                     | Programmable Active Droop™  | TinyLogic®  |
| CorePLUS™  | Green FPS™ e-Series™                           | QFET®   | TINYOPTO™   |
| CorePOWER™   | Gmax™  | QS™   | TinyPower™  |
| CROSSVOLT™   | GTO™   | Quiet Series™   | TinyPWM™  |
| CTL™   | IntelliMAX™                                    | RapidConfigure™   | TinyWire™   |
| Current Transfer Logic™  | ISOPANAR™                                      |  ™ | TranSiC™  |
| DEUXPEED®  | Making Small Speakers Sound Louder and Better™ | Saving our world, 1mW/W/kW at a time™   | TriFault Detect™  |
| Dual Cool™   | MegaBuck™                                      | SignalWise™   | TRUECURRENT®*   |
| EcoSPARK®  | MICROCOUPLER™                                  | SmartMax™   | µSerDes™  |
| EfficientMax™  | MicroFET™                                      | SMART START™  |  SerDes™         |
| ESBC™  | MicroPak™                                      | Solutions for Your Success™   | UHC®  |
|  Fairchild® | MicroPak2™                                     | SPM®  | Ultra FRFET™  |
| Fairchild Semiconductor®   | MillerDrive™                                   | STEALTH™  | UniFET™   |
| FACT Quiet Series™   | MotionMax™                                     | SuperFET®   | VCX™  |
| FACT®  | MotionGrid®                                    | SuperSOT™-3   | VisualMax™  |
| FAST®  | MTi®   | SuperSOT™-6   | VoltagePlus™  |
| FastvCore™   | MTx®   | SuperSOT™-8   | XS™   |
| FETBench™  | MVN®   | SupreMOS®   | Xsens™  |
| FPS™   | mWSaver®                                       | SyncFET™  | 仙童™   |
|  | OptoHiT™                                       | Sync-Lock™  |   |
|  | OPTOLOGIC®                                     |   |   |

\* Trademarks of System General Corporation, used under license by Fairchild Semiconductor.

### DISCLAIMER

FAIRCHILD SEMICONDUCTOR RESERVES THE RIGHT TO MAKE CHANGES WITHOUT FURTHER NOTICE TO ANY PRODUCTS HEREIN TO IMPROVE RELIABILITY, FUNCTION, OR DESIGN. TO OBTAIN THE LATEST, MOST UP-TO-DATE DATASHEET AND PRODUCT INFORMATION, VISIT OUR WEBSITE AT [HTTP://WWW.FAIRCHILDSEMI.COM](http://www.fairchildsemi.com). FAIRCHILD DOES NOT ASSUME ANY LIABILITY ARISING OUT OF THE APPLICATION OR USE OF ANY PRODUCT OR CIRCUIT DESCRIBED HEREIN; NEITHER DOES IT CONVEY ANY LICENSE UNDER ITS PATENT RIGHTS, NOR THE RIGHTS OF OTHERS. THESE SPECIFICATIONS DO NOT EXPAND THE TERMS OF FAIRCHILD'S WORLDWIDE TERMS AND CONDITIONS, SPECIFICALLY THE WARRANTY THEREIN, WHICH COVERS THESE PRODUCTS.

### LIFE SUPPORT POLICY

FAIRCHILD'S PRODUCTS ARE NOT AUTHORIZED FOR USE AS CRITICAL COMPONENTS IN LIFE SUPPORT DEVICES OR SYSTEMS WITHOUT THE EXPRESS WRITTEN APPROVAL OF FAIRCHILD SEMICONDUCTOR CORPORATION.

As used herein:

1. Life support devices or systems are devices or systems which, (a) are intended for surgical implant into the body or (b) support or sustain life, and (c) whose failure to perform when properly used in accordance with instructions for use provided in the labeling, can be reasonably expected to result in a significant injury of the user.
2. A critical component in any component of a life support, device, or system whose failure to perform can be reasonably expected to cause the failure of the life support device or system, or to affect its safety or effectiveness.

### ANTI-COUNTERFEITING POLICY

Fairchild Semiconductor Corporation's Anti-Counterfeiting Policy. Fairchild's Anti-Counterfeiting Policy is also stated on our external website, [www.fairchildsemi.com](http://www.fairchildsemi.com), under Sales Support.

Counterfeiting of semiconductor parts is a growing problem in the industry. All manufacturers of semiconductor products are experiencing counterfeiting of their parts. Customers who inadvertently purchase counterfeit parts experience many problems such as loss of brand reputation, substandard performance, failed applications, and increased cost of production and manufacturing delays. Fairchild is taking strong measures to protect ourselves and our customers from the proliferation of counterfeit parts. Fairchild strongly encourages customers to purchase Fairchild parts either directly from Fairchild or from Authorized Fairchild Distributors who are listed by country on our web page cited above. Products customers buy either from Fairchild directly or from Authorized Fairchild Distributors are genuine parts, have full traceability, meet Fairchild's quality standards for handling and storage and provide access to Fairchild's full range of up-to-date technical and product information. Fairchild and our Authorized Distributors will stand behind all warranties and will appropriately address any warranty issues that may arise. Fairchild will not provide any warranty coverage or other assistance for parts bought from Unauthorized Sources. Fairchild is committed to combat this global problem and encourage our customers to do their part in stopping this practice by buying direct or from authorized distributors.

### PRODUCT STATUS DEFINITIONS

#### Definition of Terms

Datasheet Identification	Product Status	Definition
Advance Information	Formative / In Design	Datasheet contains the design specifications for product development. Specifications may change in any manner without notice.
Preliminary	First Production	Datasheet contains preliminary data; supplementary data will be published at a later date. Fairchild Semiconductor reserves the right to make changes at any time without notice to improve design.
No Identification Needed	Full Production	Datasheet contains final specifications. Fairchild Semiconductor reserves the right to make changes at any time without notice to improve the design.
Obsolete	Not In Production	Datasheet contains specifications on a product that is discontinued by Fairchild Semiconductor. The datasheet is for reference information only.

Rev. I72