

PNP General Purpose Transistor

 Lead(Pb)-Free

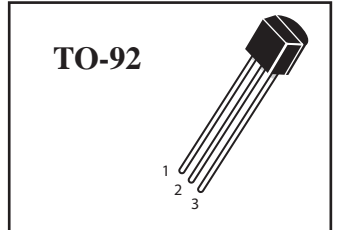
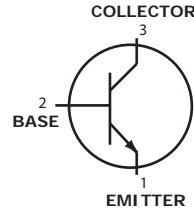

Maximum Ratings ($T_A=25^\circ\text{C}$ unless otherwise noted)

Rating	Symbol	BC556	BC557	BC558	Unit
Collector-Emitter Voltage	VECO	-65	-45	-30	Vdc
Collector-Base Voltage	VCBO	-80	-50	-30	Vdc
Emitter-Base Voltage	VEBO	-5	-5	-5	Vdc
Collector Current Continuous	I_C	100			mAdc

THERMAL CHARACTERISTICS

Characteristics	Symbol	Max	Unit
Total Device Dissipation Alumina Substrate, $T_A = 25^\circ\text{C}$	BC556 BC557 BC558 P_D	625	mW/ $^\circ\text{C}$
Junction and Storage, Temperature	BC556 BC557 BC558 T_J, T_{stg}	-55 to +150	$^\circ\text{C}$

ELECTRICAL CHARACTERISTICS

Characteristics	Symbol	Min	Max	Unit
-----------------	--------	-----	-----	------

OFF CHARACTERISTICS

Collector-Emitter Breakdown Voltage ($I_C = 2 \text{ mAdc. } I_B = 0$)	BC556 BC557 BC558	$V_{(BR)CEO}$	-65 -45 -30	- - -	Vdc
Collector-Base Breakdown Voltage ($I_C = 100 \mu\text{Adc. } I_E = 0$)	BC556 BC557 BC558	$V_{(BR)CBO}$	-80 -50 -30	- - -	Vdc
Emitter-Base Breakdown Voltage ($I_E = 100 \mu\text{Adc. } I_C = 0$)	BC556 BC557 BC558	$V_{(BR)EBO}$	-5	-	Vdc

BC556, A/B
BC557, A/B/C
BC558, A/B/C



ELECTRICAL CHARACTERISTICS ($T_A=25^{\circ}\text{C}$ unless otherwise noted) (Continued)

Characteristics	Symbol	Min	Max	Unit
-----------------	--------	-----	-----	------

OFF CHARACTERISTICS

Collector Cutoff Current ($V_{CE}=-60\text{V}$, $I_B=0$) ($V_{CE}=-40\text{V}$, $I_B=0$) ($V_{CE}=-25\text{V}$, $I_B=0$)	BC556	I _{CEO}	-	-0.1	μA
	BC557		-		
	BC558		-		
Collector Cutoff Current ($V_{CB}=-70\text{V}$, $I_E=0$) ($V_{CB}=-45\text{V}$, $I_E=0$) ($V_{CB}=-25\text{V}$, $I_E=0$)	BC556	I _{CBO}	-	-0.1	μA
	BC557		-		
	BC558		-		
Emitter Cutoff Current ($V_{EB}=-5.0\text{Vdc}$, $I_C=0$)	BC556 BC557 BC558	I _{EBO}	-	-0.1	μA

ON CHARACTERISTICS

DC current gain ($V_{CE}=-5\text{V}$, $I_C=-2\text{mA}$)	BC556	h _{FE}	120	500	
	BC557		120	800	
	BC558		120	800	
	BC556A/BC557A/BC558A		120	220	
	BC556B/BC557B/BC558B		180	460	
	BC557C/BC558C		420	800	
Collector-emitter saturation voltage ($I_C=-100\text{mA}$, $I_B=-5\text{mA}$)		V _{CE(sat)}	-	-0.3	V
Base-emitter saturation voltage ($I_C=-100\text{mA}$, $I_B=-5\text{mA}$)		V _{BE(sat)}	-	-1	V
Transition frequency ($V_{CE}=-5\text{V}$, $I_C=-10\text{mA}$, $f=100\text{MHz}$)		f _T	150	-	MHz

BC557/BC558

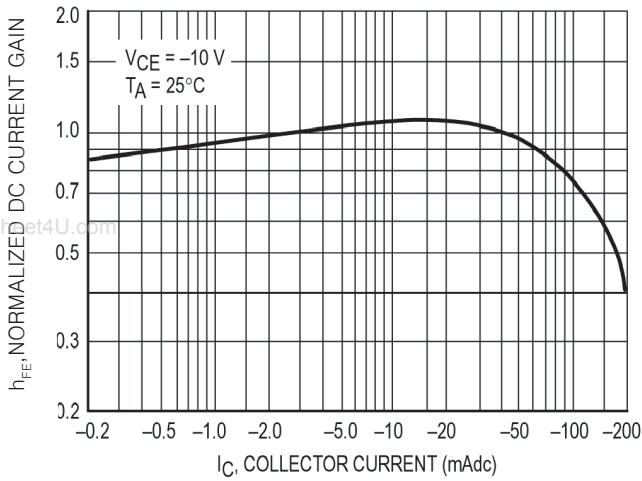

Normalized DC Current Gain

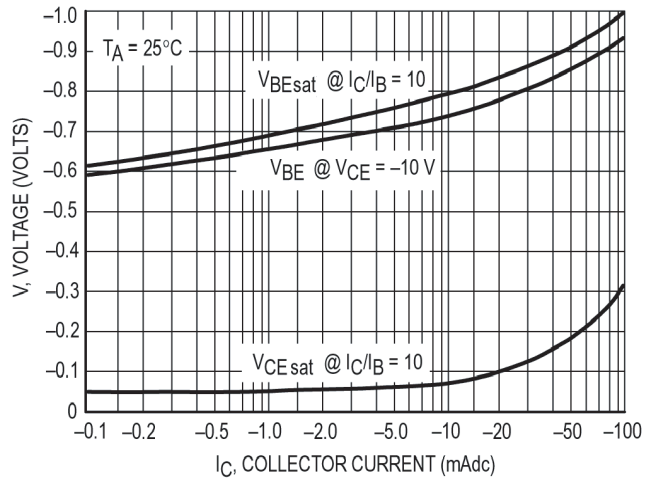

"Saturation" and "On" Voltages

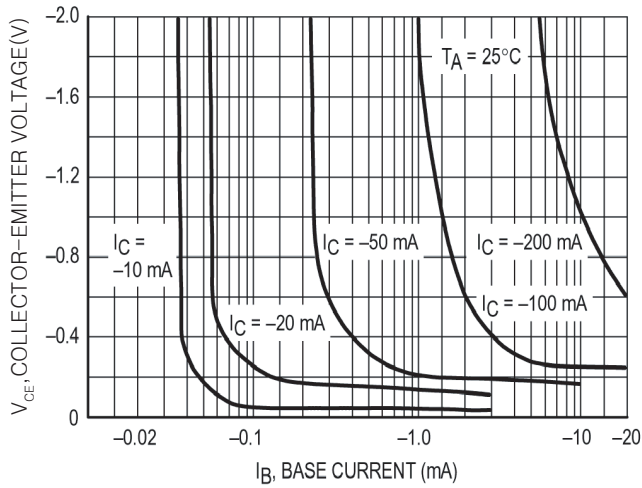

Collector Saturation Region

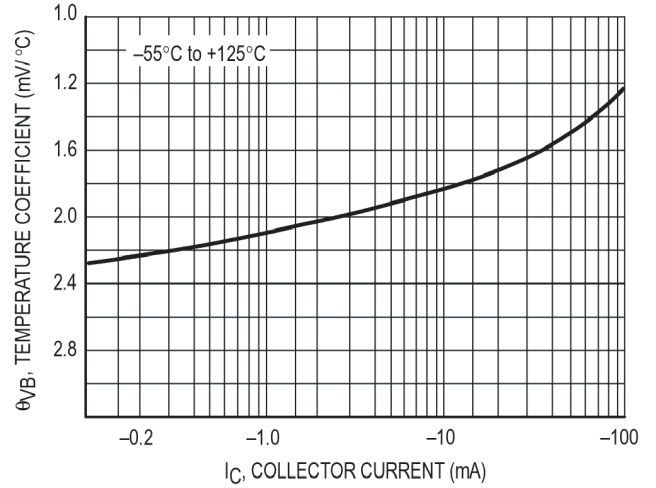

Base-Emitter Temperature Coefficient

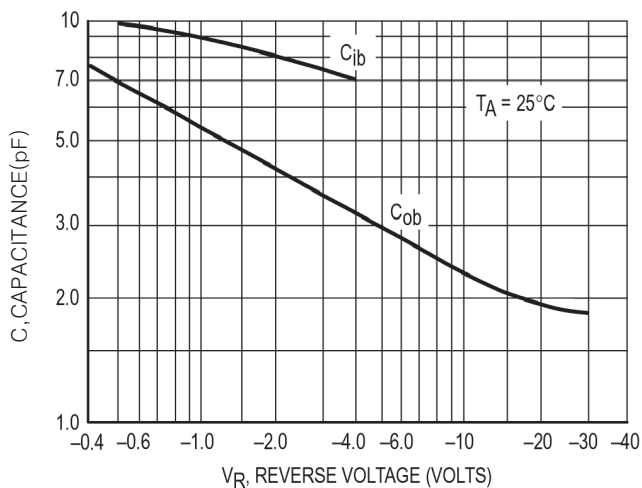

Capacitances

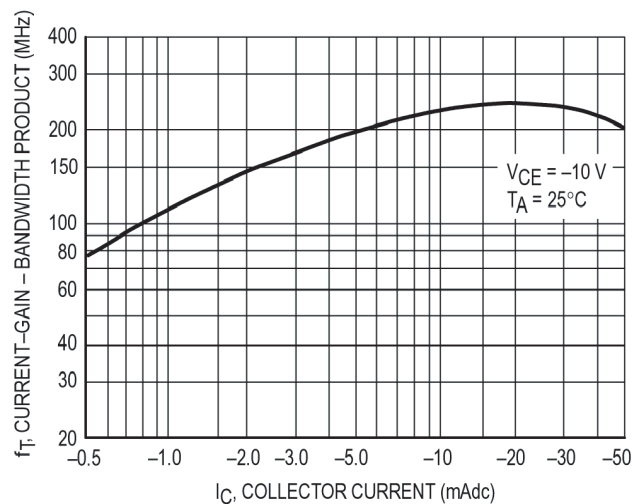

Current-Gain - Bandwidth Product

BC556

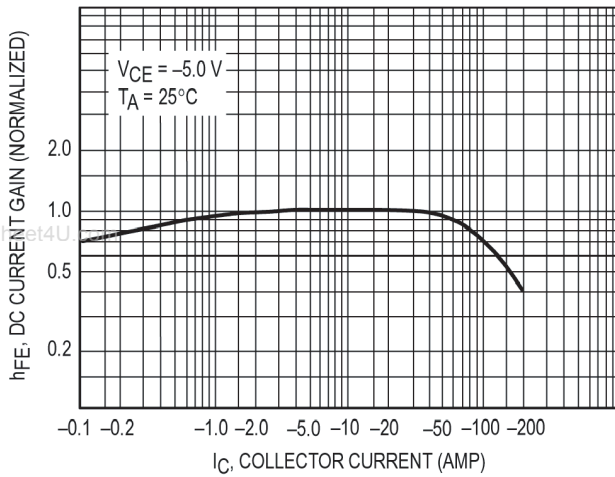

DC Current Gain

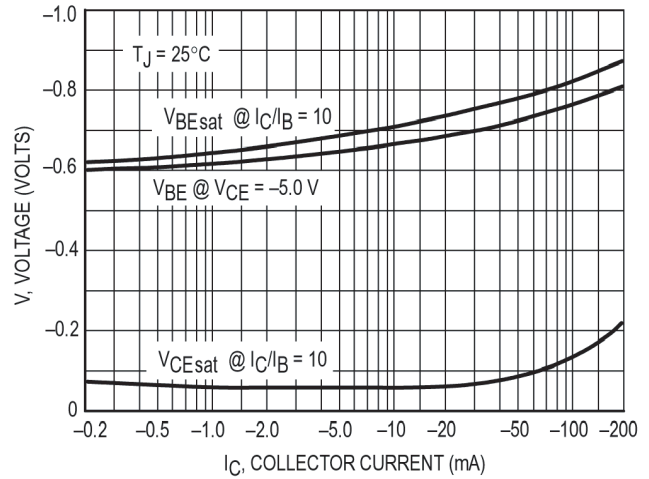

"On" Voltage

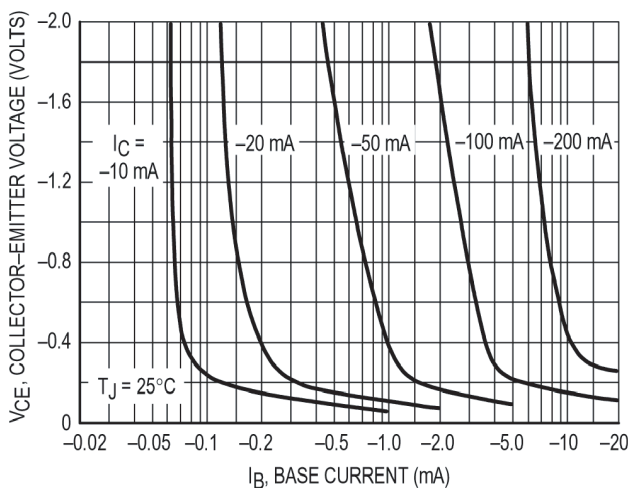

Collector Saturation Region

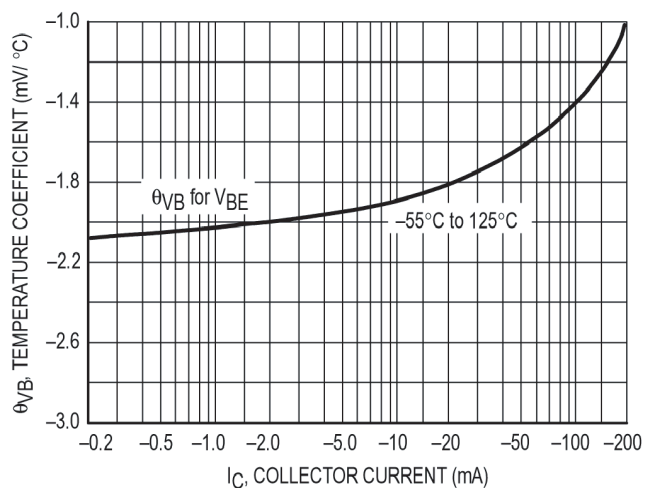

Base-Emitter Temperature Coefficient

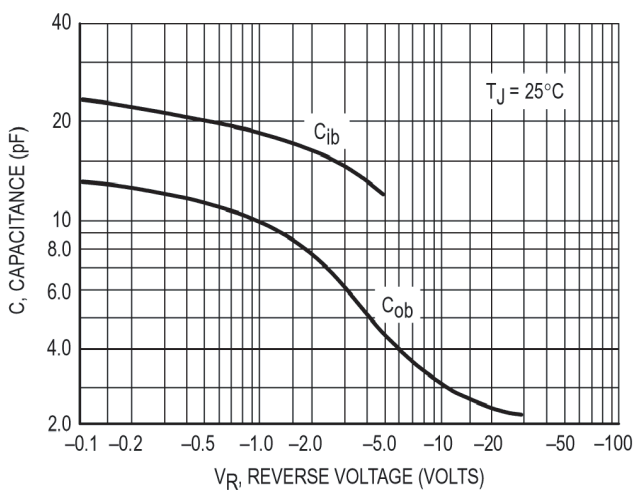

Capacitance

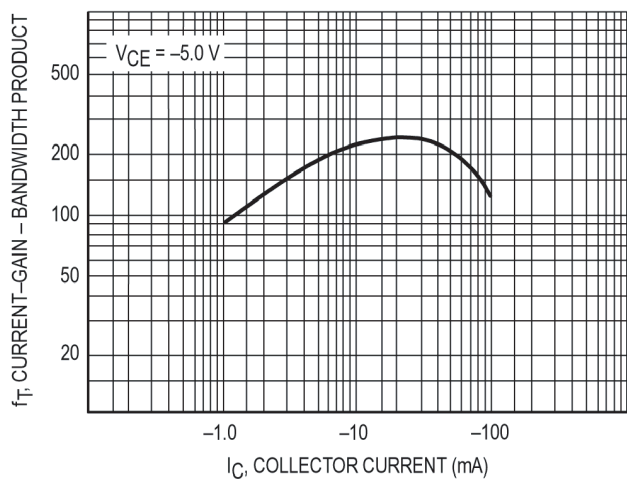

Current-Gain - Bandwidth Product

TO-92 Outline Dimensions

unit:mm

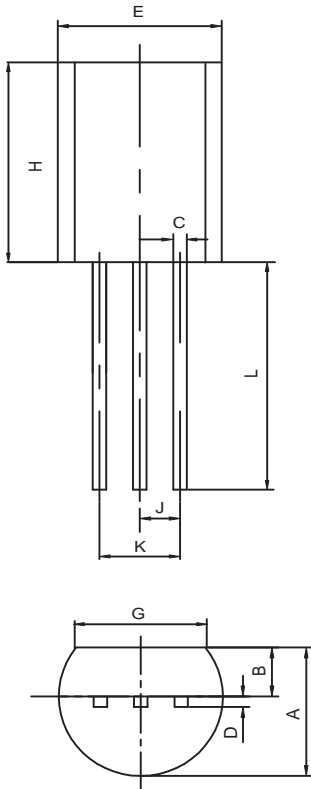

TO-92		
Dim	Min	Max
A	3.30	3.70
B	1.10	1.40
C	0.38	0.55
D	0.36	0.51
E	4.40	4.70
G	3.43	-
H	4.30	4.70
J	1.270TYP	
K	2.44	2.64
L	14.10	14.50