

# DATA SHEET

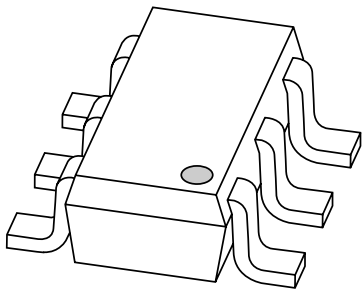

## **BC807DS** PNP general purpose double transistor

Product specification  
Supersedes data of 2002 Aug 09

2002 Nov 22

# PNP general purpose double transistor

# BC807DS

### FEATURES

- High current (500 mA)
- 600 mW total power dissipation
- Replaces two SOT23 packaged transistors on same PCB area.

### APPLICATIONS

- General purpose switching and amplification
- Push-pull amplifiers
- Multi-phase stepper motor drivers.

### DESCRIPTION

PNP transistor pair in a SOT457 (SC-74) plastic package.

### MARKING

TYPE NUMBER	MARKING CODE
BC807DS	N2

### QUICK REFERENCE DATA

SYMBOL	PARAMETER	MAX.	UNIT
$V_{CEO}$	collector-emitter voltage	-45	V
$I_C$	collector current (DC)	-500	mA
$I_{CM}$	peak collector current	-1	A

### PINNING

PIN	DESCRIPTION
1, 4	emitter TR1; TR2
2, 5	base TR1; TR2
6, 3	collector TR1; TR2

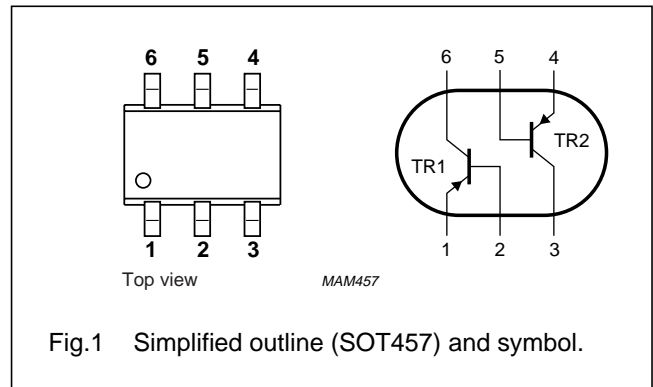

### LIMITING VALUES

In accordance with the Absolute Maximum Rating System (IEC 60134).

SYMBOL	PARAMETER	CONDITIONS	MIN.	MAX.	UNIT
<b>Per transistor unless otherwise specified</b>					
$V_{CBO}$	collector-base voltage	open emitter	-	-50	V
$V_{CEO}$	collector-emitter voltage	open base	-	-45	V
$V_{EBO}$	emitter-base voltage	open collector	-	-5	V
$I_C$	collector current (DC)		-	-500	mA
$I_{CM}$	peak collector current		-	-1	A
$I_{BM}$	peak base current		-	-200	mA
$P_{tot}$	total power dissipation	$T_{amb} \leq 25\text{ }^\circ\text{C}$ ; note 1	-	370	mW
$T_{stg}$	storage temperature		-65	+150	$^\circ\text{C}$
$T_j$	junction temperature		-	150	$^\circ\text{C}$
$T_{amb}$	operating ambient temperature		-65	+150	$^\circ\text{C}$
<b>Per device</b>					
$P_{tot}$	total power dissipation	$T_{amb} \leq 25\text{ }^\circ\text{C}$ ; note 1	-	600	mW

### Note

1. Device mounted on a printed-circuit board; single sided copper; tinplated; mounting pad for collector 1 cm<sup>2</sup>.

## PNP general purpose double transistor

## BC807DS

## THERMAL CHARACTERISTICS

SYMBOL	PARAMETER	CONDITIONS	VALUE	UNIT
$R_{th\ j-a}$	thermal resistance from junction to ambient	note 1	208	K/W

## Note

1. Device mounted on a printed-circuit board; single sided copper; tinplated; mounting pad for collector 1 cm<sup>2</sup>.

## CHARACTERISTICS

$T_{amb} = 25\text{ °C}$  unless otherwise specified.

SYMBOL	PARAMETER	CONDITIONS	MIN.	TYP.	MAX.	UNIT
<b>Per transistor</b>						
$I_{CBO}$	collector-base cut-off current	$V_{CB} = -20\text{ V}; I_E = 0$	–	–	–100	nA
		$V_{CB} = -20\text{ V}; I_E = 0; T_j = 150\text{ °C}$	–	–	–5	μA
$I_{EBO}$	emitter-base cut-off current	$V_{EB} = -5\text{ V}; I_C = 0$	–	–	–100	nA
$h_{FE}$	DC current gain	$V_{CE} = -1\text{ V}; I_C = -100\text{ mA}; \text{note 1}$	160	–	400	
		$V_{CE} = -1\text{ V}; I_C = -500\text{ mA}; \text{note 1}$	40	–	–	
$V_{CEsat}$	collector-emitter saturation voltage	$I_C = -500\text{ mA}; I_B = -50\text{ mA}; \text{note 1}$	–	–	–700	mV
$V_{BE}$	base-emitter voltage	$V_{CE} = -1\text{ V}; I_C = -500\text{ mA}; \text{notes 1 and 2}$	–	–	–1.2	V
$C_c$	collector capacitance	$V_{CB} = -10\text{ V}; I_E = I_e = 0; f = 1\text{ MHz}$	–	9	–	pF
$f_T$	transition frequency	$V_{CE} = -5\text{ V}; I_C = -10\text{ mA}; f = 100\text{ MHz}$	80	–	–	MHz

## Notes

1. Pulse test:  $t_p \leq 300\text{ μs}; \delta \leq 0.02$ .
2.  $V_{BE}$  decreases by approximately  $-2\text{ mV/K}$  with increasing temperature.

PNP general purpose double transistor

BC807DS

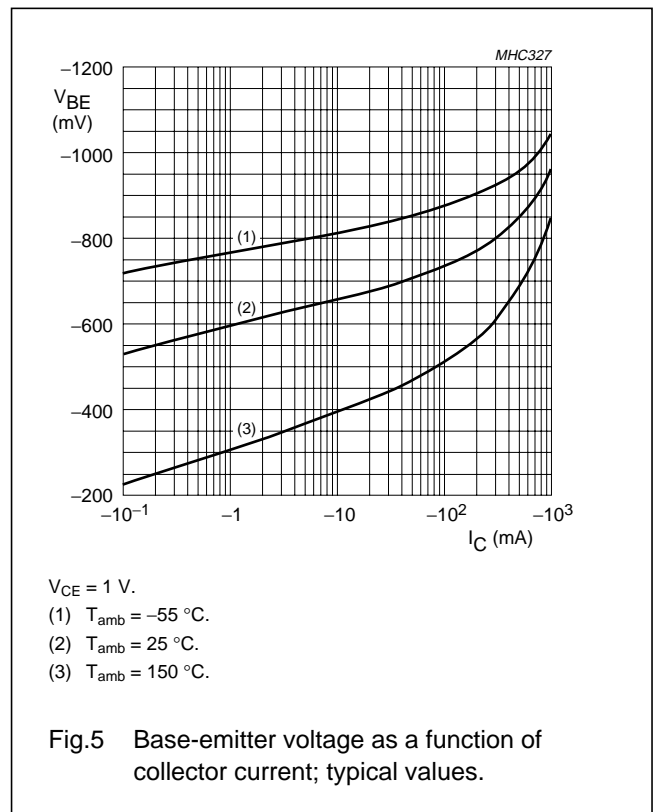
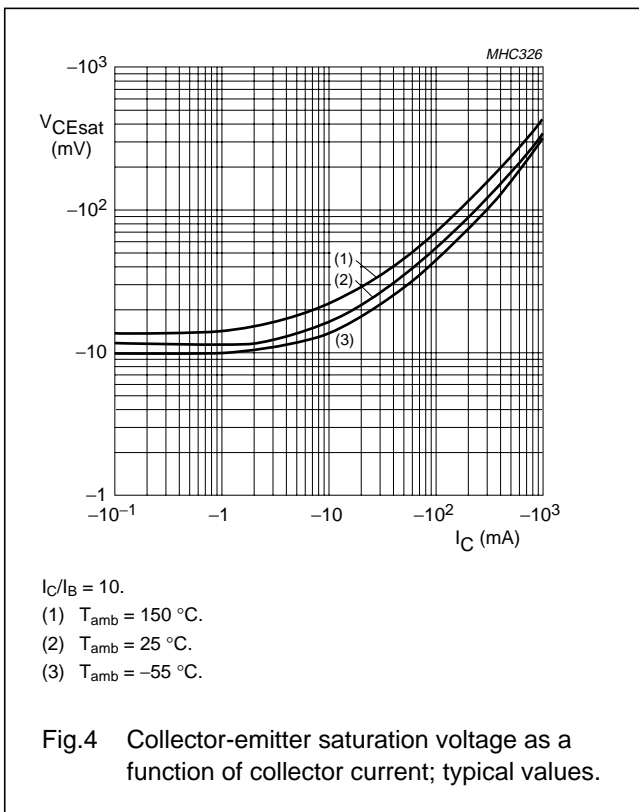
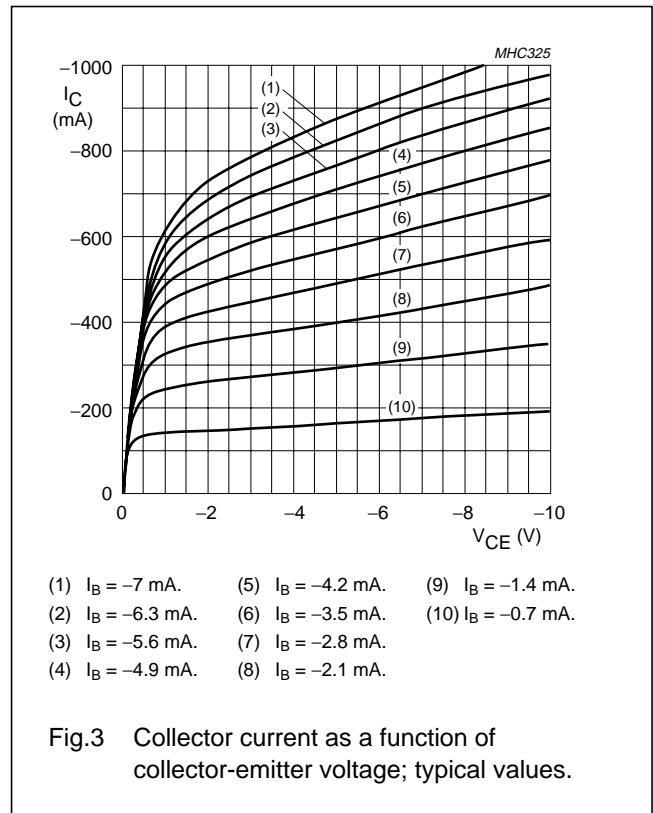
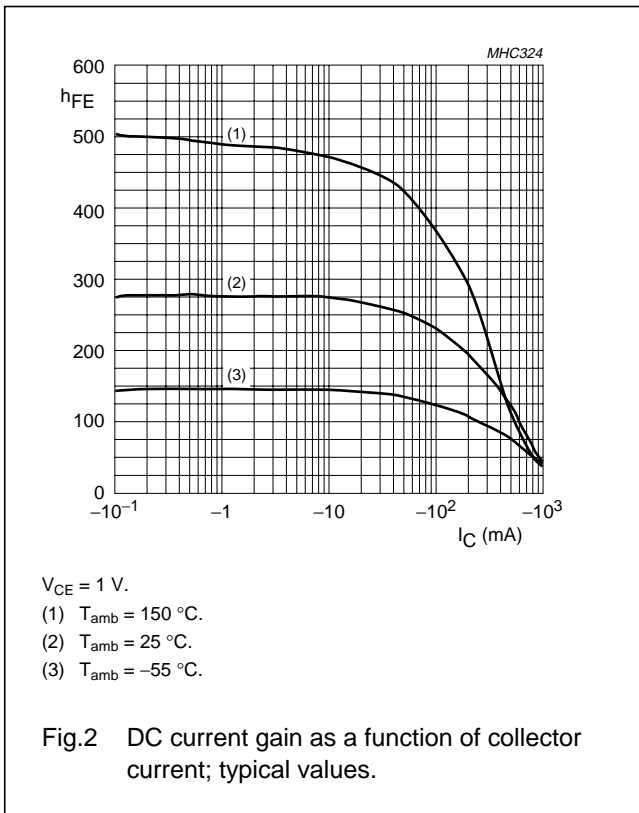

PNP general purpose double transistor

BC807DS

PACKAGE OUTLINE

Plastic surface mounted package; 6 leads

SOT457

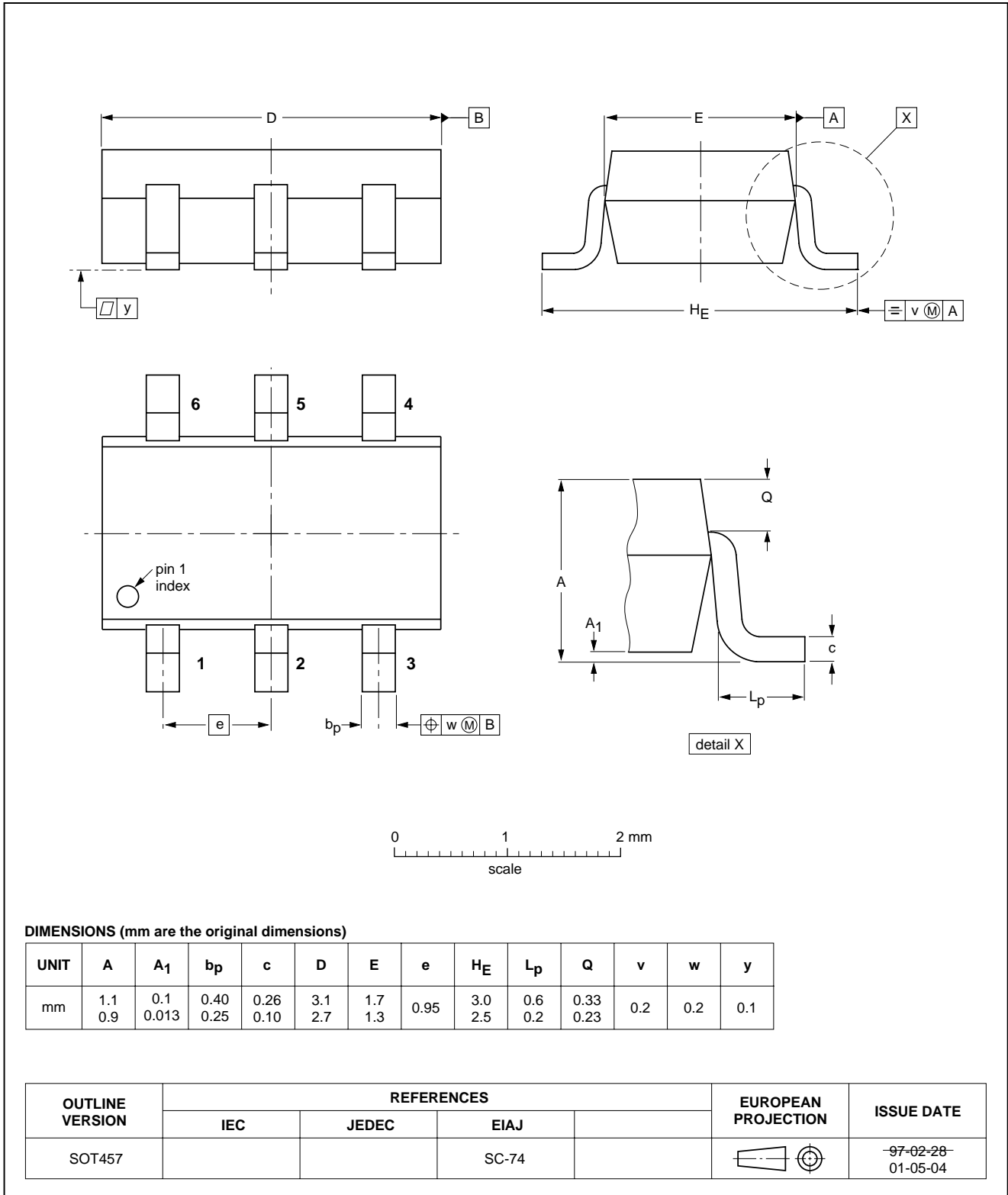

## PNP general purpose double transistor

BC807DS

## DATA SHEET STATUS

LEVEL	DATA SHEET STATUS <sup>(1)</sup>	PRODUCT STATUS <sup>(2)(3)</sup>	DEFINITION
I	Objective data	Development	This data sheet contains data from the objective specification for product development. Philips Semiconductors reserves the right to change the specification in any manner without notice.
II	Preliminary data	Qualification	This data sheet contains data from the preliminary specification. Supplementary data will be published at a later date. Philips Semiconductors reserves the right to change the specification without notice, in order to improve the design and supply the best possible product.
III	Product data	Production	This data sheet contains data from the product specification. Philips Semiconductors reserves the right to make changes at any time in order to improve the design, manufacturing and supply. Relevant changes will be communicated via a Customer Product/Process Change Notification (CPCN).

## Notes

1. Please consult the most recently issued data sheet before initiating or completing a design.
2. The product status of the device(s) described in this data sheet may have changed since this data sheet was published. The latest information is available on the Internet at URL <http://www.semiconductors.philips.com>.
3. For data sheets describing multiple type numbers, the highest-level product status determines the data sheet status.

## DEFINITIONS

**Short-form specification** — The data in a short-form specification is extracted from a full data sheet with the same type number and title. For detailed information see the relevant data sheet or data handbook.

**Limiting values definition** — Limiting values given are in accordance with the Absolute Maximum Rating System (IEC 60134). Stress above one or more of the limiting values may cause permanent damage to the device. These are stress ratings only and operation of the device at these or at any other conditions above those given in the Characteristics sections of the specification is not implied. Exposure to limiting values for extended periods may affect device reliability.

**Application information** — Applications that are described herein for any of these products are for illustrative purposes only. Philips Semiconductors make no representation or warranty that such applications will be suitable for the specified use without further testing or modification.

## DISCLAIMERS

**Life support applications** — These products are not designed for use in life support appliances, devices, or systems where malfunction of these products can reasonably be expected to result in personal injury. Philips Semiconductors customers using or selling these products for use in such applications do so at their own risk and agree to fully indemnify Philips Semiconductors for any damages resulting from such application.

**Right to make changes** — Philips Semiconductors reserves the right to make changes in the products - including circuits, standard cells, and/or software - described or contained herein in order to improve design and/or performance. When the product is in full production (status 'Production'), relevant changes will be communicated via a Customer Product/Process Change Notification (CPCN). Philips Semiconductors assumes no responsibility or liability for the use of any of these products, conveys no licence or title under any patent, copyright, or mask work right to these products, and makes no representations or warranties that these products are free from patent, copyright, or mask work right infringement, unless otherwise specified.

PNP general purpose double transistor

BC807DS

---

**NOTES**

# ***Philips Semiconductors – a worldwide company***

## **Contact information**

For additional information please visit <http://www.semiconductors.philips.com>. Fax: +31 40 27 24825

For sales offices addresses send e-mail to: [sales.addresses@www.semiconductors.philips.com](mailto:sales.addresses@www.semiconductors.philips.com).

© Koninklijke Philips Electronics N.V. 2002

SCA74

All rights are reserved. Reproduction in whole or in part is prohibited without the prior written consent of the copyright owner.

The information presented in this document does not form part of any quotation or contract, is believed to be accurate and reliable and may be changed without notice. No liability will be accepted by the publisher for any consequence of its use. Publication thereof does not convey nor imply any license under patent- or other industrial or intellectual property rights.

Printed in The Netherlands

613514/02/pp8

Date of release: 2002 Nov 22

Document order number: 9397 750 10581

*Let's make things better.*

**Philips  
Semiconductors**



**PHILIPS**