



BC817

NPN SILICON TRANSISTOR

NPN GENERAL PURPOSE AMPLIFIER

■ DESCRIPTION

The UTC **BC817** is designed for general purpose medium power amplifiers and switches requiring collector currents to 1.2A.

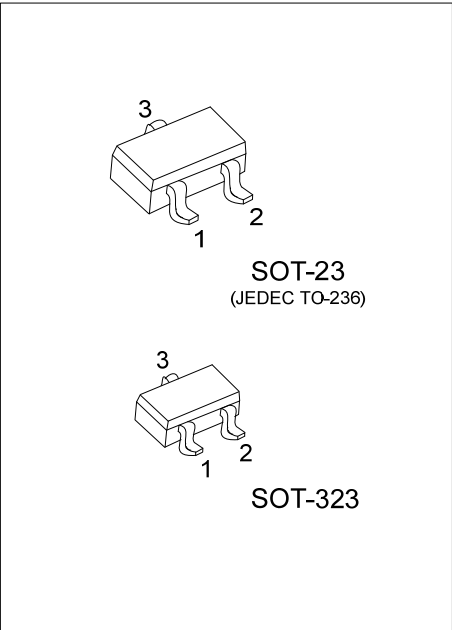

■ ORDERING INFORMATION

Ordering Number		Package	Pin Assignment			Packing
Lead Free	Halogen Free		1	2	3	
BC817L-xx-AE3-R	BC817G-xx-AE3-R	SOT-23	B	E	C	Tape Reel
BC817L-xx-AL3-R	BC817G-xx-AL3-R	SOT-323	B	E	C	Tape Reel

Note: Pin Assignment: B: Base E: Emitter C: Collector

<p>BC817G-xx-AE3-R</p>	<p>(1)Packing Type (2)Package Type (3)Rank (4)Green Package</p>	<p>(1) R: Tape Reel (2) AE3: SOT-23, AL3: SOT-323 (3) xx: refer to Classification of h_{FE1} (4) G: Halogen Free and Lead Free, L: Lead Free</p>
------------------------	---	--

■ MARKING

BC817-16	BC817-25	BC817-40
<p>L: Lead Free G: Halogen Free</p>	<p>L: Lead Free G: Halogen Free</p>	<p>L: Lead Free G: Halogen Free</p>

■ ABSOLUTE MAXIMUM RATINGS (T_A=25°C, unless otherwise specified)

PARAMETER		SYMBOL	RATINGS	UNIT
Collector-Base Voltage		V _{CES}	50	V
Collector-Emitter Voltage		V _{CEO}	45	V
Emitter-Base Voltage		V _{EBO}	5.0	V
Collector Current -Continuous	Continuous	I _C	1.5	A
	Peak	I _{CM}	1.7	A
Collector Dissipation	SOT-23	P _C	310	mW
	SOT-323		200	mW
Junction Temperature		T _J	+150	°C
Storage Temperature		T _{STG}	-65 ~ +150	°C

Note: Absolute maximum ratings are those values beyond which the device could be permanently damaged. Absolute maximum ratings are stress ratings only and functional device operation is not implied.

■ THERMAL DATA

PARAMETER		SYMBOL	RATINGS	UNIT
Junction to Ambient	SOT-23	θ _{JA}	403	°C/W
	SOT-323		625	°C/W

Note: The data tested by surface mounted on a 1 inch² FR-4 board with 2OZ copper.

■ ELECTRICAL CHARACTERISTICS (T_A=25°C, unless otherwise specified)

PARAMETER	SYMBOL	TEST CONDITIONS	MIN	TYP	MAX	UNIT
OFF CHARACTERISTICS						
Collector-Emitter Breakdown Voltage	BV _{CEO}	I _C =10mA, I _B =0	45			V
Collector-Base Breakdown Voltage	BV _{CES}	I _C =100μA, I _E =0	50			V
Emitter-Base Breakdown Voltage	BV _{EBO}	I _E =10μA, I _C =0	5			V
Collector Cut-OFF Current	I _{CBO}	V _{CB} =20V			100	nA
		V _{CB} =20V, T _A =150°C			5	μA
Collector Cutoff Current	I _{CEO}	V _{CE} =45V			100	nA
Emitter Cutoff Current	I _{EBO}	V _{EB} =5V			100	nA
ON CHARACTERISTICS						
DC Current Gain	h _{FE1}	I _C =100mA, V _{CE} =1.0V	See Classification			
	h _{FE2}	I _C =500mA, V _{CE} =1.0V	40			
Collector-Emitter Saturation Voltage	V _{CE(SAT)}	I _C =500mA, I _B =50mA			0.7	V
Base-Emitter Saturation Voltage	V _{BE(SAT)}	I _C =500mA, I _B =50mA			1.2	V
Base-Emitter On Voltage	V _{BE(ON)}	I _C =500mA, V _{CE} =1.0V			1.2	V

■ CLASSIFICATION OF h_{FE1}

RANK	16	25	40
RANGE	100-250	160-400	250-600

TYPICAL CHARACTERISTICS

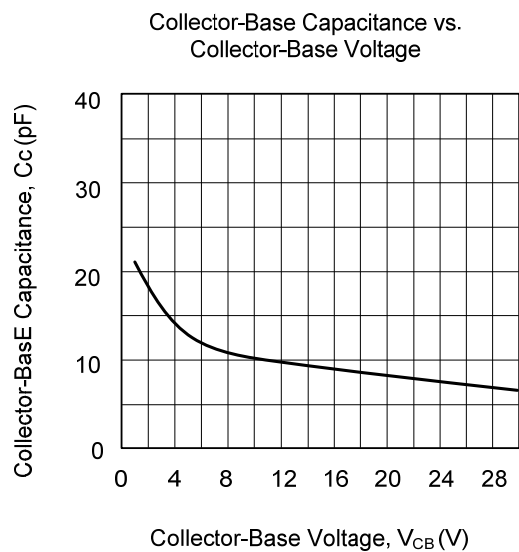
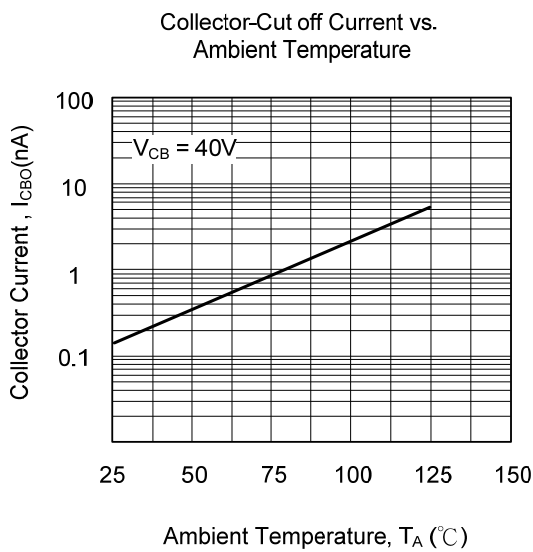
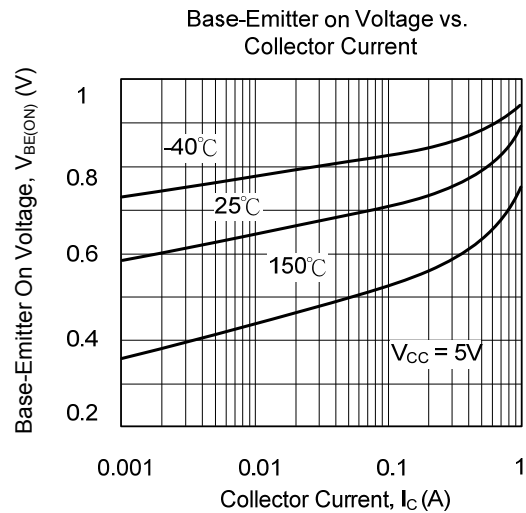
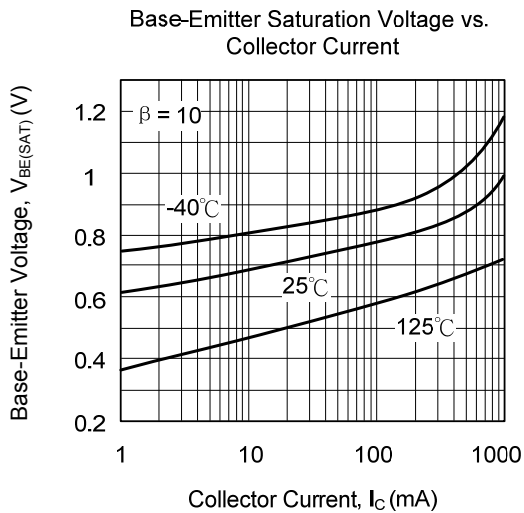
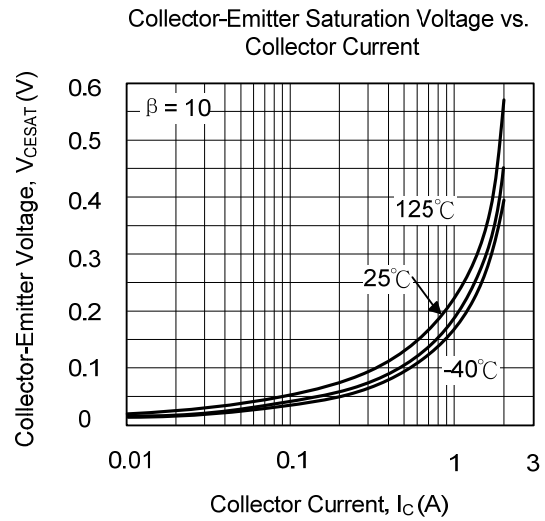
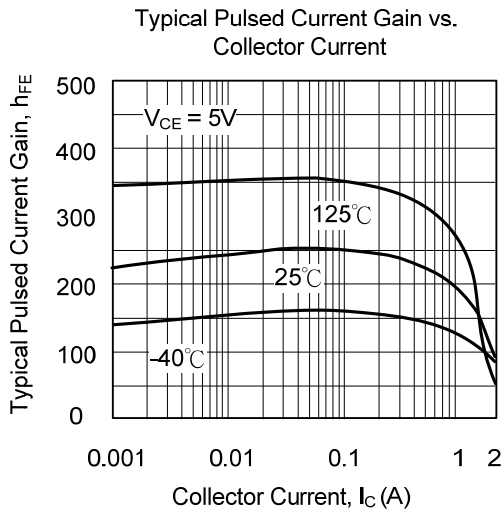

■ TYPICAL CHARACTERISTICS(Cont.)

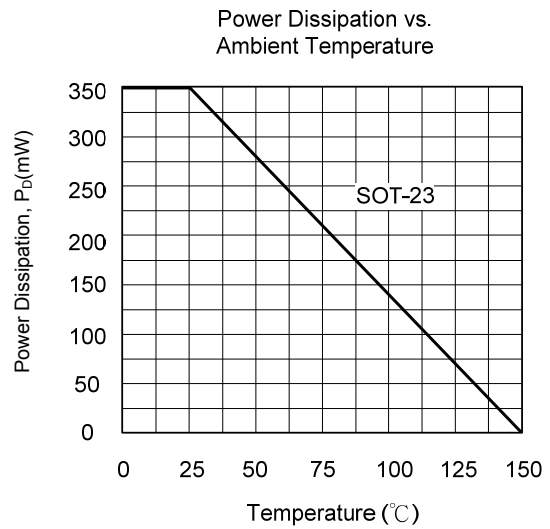
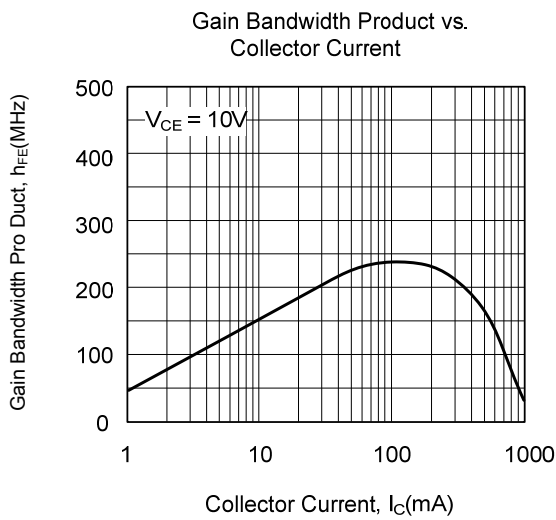

UTC assumes no responsibility for equipment failures that result from using products at values that exceed, even momentarily, rated values (such as maximum ratings, operating condition ranges, or other parameters) listed in products specifications of any and all UTC products described or contained herein. UTC products are not designed for use in life support appliances, devices or systems where malfunction of these products can be reasonably expected to result in personal injury. Reproduction in whole or in part is prohibited without the prior written consent of the copyright owner. UTC reserves the right to make changes to information published in this document, including without limitation specifications and product descriptions, at any time and without notice. This document supersedes and replaces all information supplied prior to the publication hereof.